



IEA
SOLAR R&D

INTERNATIONAL ENERGY AGENCY

solar heating and
cooling programme

Proceedings of the International Energy Agency Conference on Pyranometer Measurements

Final Report

**16-20 March 1981
Boulder, Colorado**

Task V

Solar Energy Research Institute

1617 Cole Boulevard
Golden, Colorado 80401

Operated for the U.S. Department of Energy by Midwest Research Institute

October 1982

This report is part of the work of the International Energy Agency
Solar Heating and Cooling Programme

Task V

Use of Existing Meteorological Information
for Solar Energy Applications

In Conjunction with

Task III

Performance Testing of Solar Collectors

Edited and with Introductory Material by
Michael R. Riches
Thomas L. Stoffel
Chester V. Wells

Solar Energy Research Institute

1617 Cole Boulevard
Golden, Colorado 80401
USA

SERI/TR-642-1156R

Proceedings of the International Energy Agency Conference on Pyranometer Measurements

Final Report

**16 - 20 March 1981
Boulder, Colorado**

**Edited and with Introductory Material by
Michael R. Riches
Office of Energy Research
Department of Energy
Washington, D.C.**

**Thomas L. Stoffel
Chester V. Wells**

**Renewable Resource Assessment and
Instrumentation Branch
Solar Energy Research Institute**

October 1982

**Prepared Under Task Nos. 1093.00, 1327.00, and 1335.00
WPA Nos. 03-357, 02-304, and 01-256**

Solar Energy Research Institute

A Division of Midwest Research Institute

1617 Cole Boulevard
Golden, Colorado 80401

Prepared for the
U.S. Department of Energy
Contract No. EG-77-C-01-4042

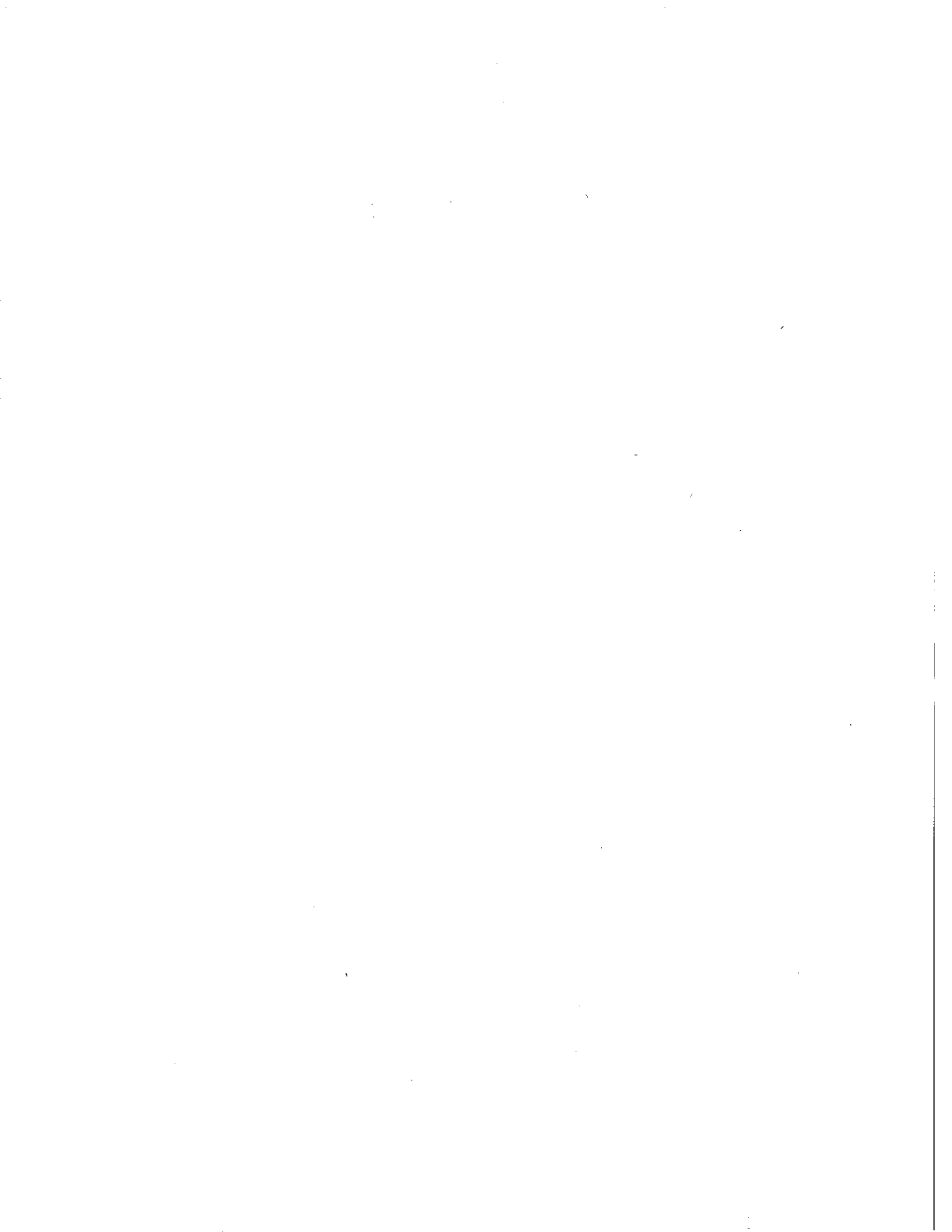

PREFACE

A conference of pyranometry measurement experts from seven nations was held 16-20 March 1981 in Boulder, Colorado, USA, under the auspices of the International Energy Agency, the United States Department of Energy, and the Solar Energy Research Institute. This report documents the technical presentations, background, and the results and recommendations of the conference.

The facilities of the National Center for Atmospheric Research in Boulder, Colorado, were kindly made available for the conference. The surroundings and arrangements were greatly appreciated and contributed to the success of the conference.

Approved for

SOLAR ENERGY RESEARCH INSTITUTE

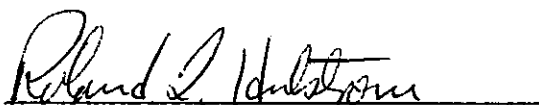

Roland Hulstrom, Chief
Renewable Resource Assessment and
Instrumentation Branch

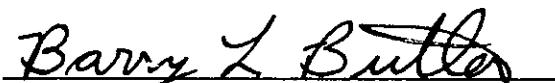

Barry Butler, Manager
Solar Thermal and Materials
Research Division

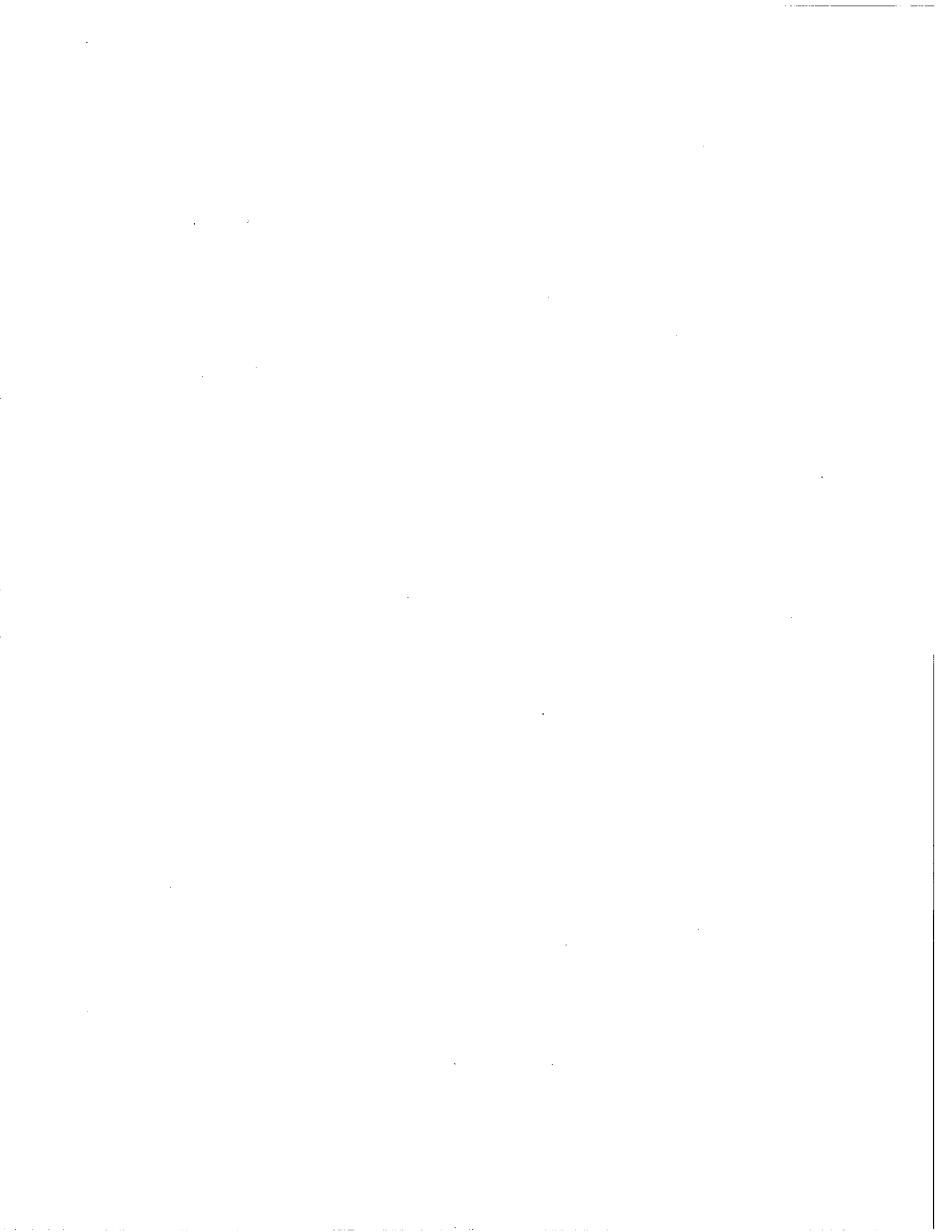

SUMMARY

A conference of pyranometry experts from seven nations was held in Boulder, Colorado, from 16-20 March 1981 for the purpose of formulating a statement of work for joint pyranometer experiments and calibrations. Recent round robin testing of solar collectors conducted by the IEA Solar Heating and Cooling Program Task III had demonstrated a need for better understanding of pyranometry measurements.

The conference was successful in the exchange of technical results, discussions, recommendations, setting of goals, and a statement of work for further activities. The goals established as a result of the conference were:

- Goal I - Establish the state of the art in pyranometry measurements, especially as it pertains to collector performance testing.
- Goal II - Determine ways to improve the measurement accuracies of pyranometers currently available by developing a more complete understanding of the instruments' performance characteristics.

A Statement of Work was prepared on the basis of the technical information and discussions. The Statement of Work defines the nature and level of effort required to satisfy the needs of the nonmeteorological uses of pyranometers, especially the use of pyranometers in solar collector testing. A summary of the steps involved in the implementation of the Statement of Work is found in the accompanying milestone log.

Among the key recommendations of the attendees was the recognition that the proposed work would have a significantly broader and longer term importance if the World Meteorological Organization (WMO) could become involved. This involvement would concentrate specifically on improvement of the state of the art in pyranometry.

A wealth of technical results and information on pyranometry was presented during the course of the conference. This information is intended for both the expert and the novice in pyranometer measurements because of the intended wide distribution. The material was kindly supplied by various authors and it has generally been presented verbatim and in the form received by SERI in the appendices of this report.

A complete list of names and affiliations of those in attendance is included in Appendix A.

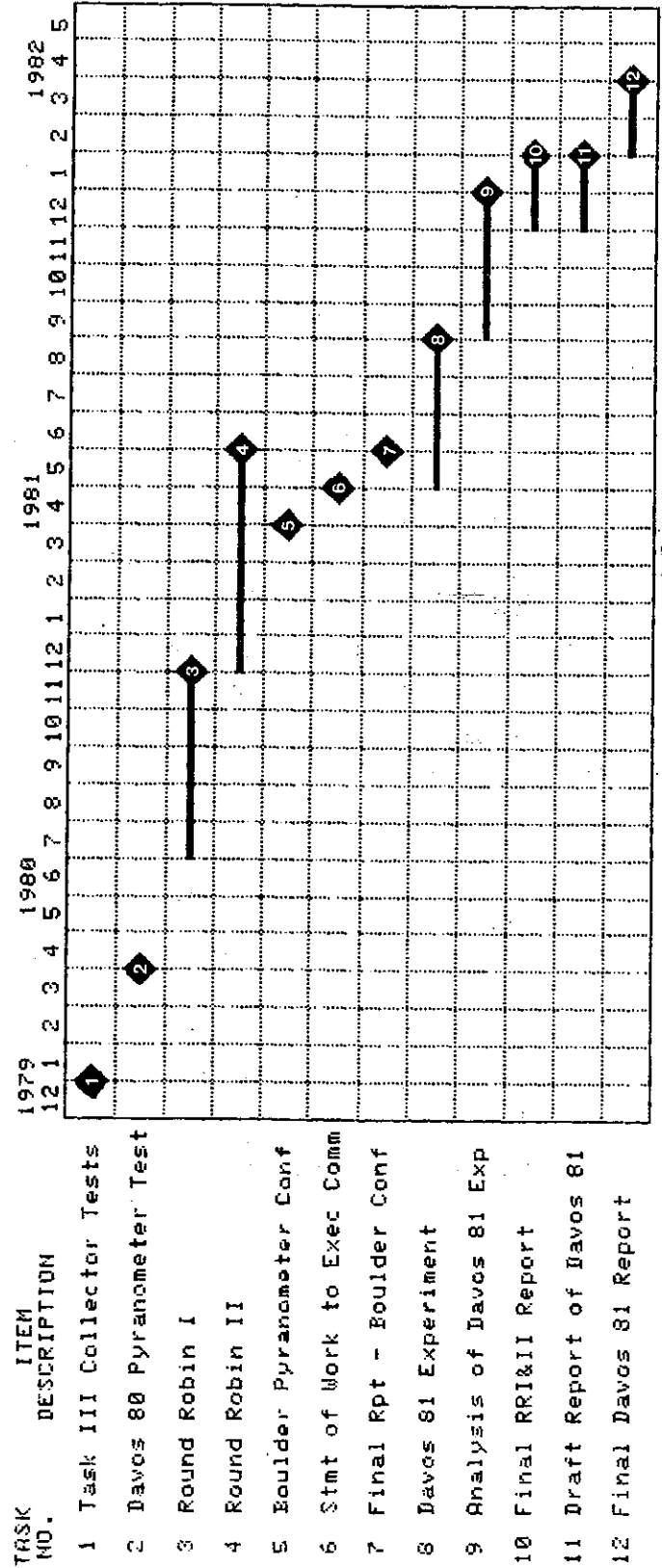

Figure S-1. Summary Milestone Log

TABLE OF CONTENTS

	<u>Page</u>
1.0 Background and Opening Remarks.....	1
1.1 Background.....	1
1.2 Opening Remarks.....	5
2.0 Conference Insights, Suggestions, and Recommendations.....	7
2.1 Insights.....	7
2.2 Pyranometer Interaction Characteristics and Sequence of Tests....	8
2.3 Recommendations.....	9
2.3.1 For a Post-Experiment Round Robin.....	9
2.3.2 For an Education and Dissemination Program.....	9
2.3.3 Working Document by W. B. Gillett.....	9
2.3.4 Concerning a Work Statement.....	9
2.3.5 General Recommendations.....	11
3.0 Statement of Work.....	13
3.1 Introduction.....	13
3.2 Definitions.....	14
3.3 Purpose.....	14
3.4 Brief Statement of Goals.....	14
3.5 Full Statement of Goal I.....	14
3.5.1 Objectives of Goal I.....	15
3.5.2 Approach to Goal I.....	15
3.5.2.1 Complete Round Robin II Testing.....	15
3.5.2.2 Provide an Interim Analysis.....	17
3.5.2.3 Disposition of Pyranometers.....	17
3.5.3 Products of Goal I.....	18
3.5.3.1 Documentation.....	18
3.5.3.2 Characterized Pyranometers.....	18
3.6 Full Statement of Goal II.....	19
3.6.1 Objectives of Goal II.....	19
3.6.1.1 Objective 2.1.....	19
3.6.1.2 Objective 2.2.....	20
3.6.1.3 Objective 2.3.....	20
3.6.1.4 Objective 2.4.....	20
3.6.2 Approach to Goal II.....	20
3.6.2.1 Old Instruments to be Tested.....	20
3.6.2.2 New Instruments to be Tested.....	22
3.6.2.3 Tests at Davos.....	22
3.6.2.4 Data Analysis.....	24
3.6.3 Products of Goal II.....	24
3.6.3.1 Final Report.....	24
3.6.3.2 Handbook.....	25
3.6.3.3 Characterized Pyranometers.....	25
3.6.3.4 Experimental Test Plan.....	26

TABLE OF CONTENTS (Continued)

	<u>Page</u>
3.7 Benefits from Achieving Goals I and II.....	26
3.7.1 Knowledge of the State of the Art of Pyranometry.....	26
3.7.2 A Methodology for Achieving State of the Art Pyranometry Measurements.....	26
3.7.3 Recommendations to Achieve Improvements in Pyranometry.....	27
3.7.4 Well-Characterized Pyranometers.....	27
3.7.5 Summary.....	27
4.0 References.....	29
Bibliography.....	31
Appendix A Attendance List and Agenda.....	33
Appendix B Characteristics of Pyranometers H. Andersson, K. Dehne, R. Estey, D. Myers, T. Stoffel, and C. Wells.....	41
Appendix C Status of the Ad Hoc Round-Robin Tests Subsequent to the IEA Davos Pyranometer Comparisons of March 1980 E. Flowers, C. Fröhlich, J. Hickey, T. Stoffel, and D. Wardle.....	59
Appendix D Results of a Pyranometer Comparison, Task III: Performance Testing of Solar Collectors, a Report by the International Energy Agency Solar Heating and Cooling Program, Davos, March 5 and 6, 1980 H. Talarek, Editor.....	69
Appendix E Report on Calibration Techniques for Pyranometers: World Radiation Center, Davos, Switzerland, 1981 C. Fröhlich.....	101
Appendix F Final Summary Report: Round Robin I Calibration of Selected Pyranometers from 1980 Davos Comparison G. Zerlaut.....	107
Appendix G Report on Tests by SRF/NOAA on Pyranometers from the IEA Comparisons in Davos, March 1980 E. Flowers and R. Haas.....	125
Appendix H NOAA Solar Radiation Standards E. Flowers.....	219

TABLE OF CONTENTS (Concluded)

		<u>Page</u>
Appendix I	Report of Tests of Three Pyranometers which were Included in the March 1980 IEA Intercomparisons at Davos, Switzerland J. Hickey.....	235
Appendix J	Eppley Laboratory: Abbreviated Description of Pyranometer Calibration Techniques J. Hickey.....	243
Appendix K	The Background to NARC Calibration Methods: Explanation of Figures from Presentation at Boulder IEA Meeting, 17th March 1981 D. Wardle.....	247
Appendix L	Pyranometer Calibration Procedures at the Canadian National Atmospheric Radiation Centre D. Wardle.....	263
Appendix M	Preliminary Analysis of IEA Pyranometer Performance Comparisons: An Outdoor Tilt Table Study T. Stoffel.....	267
Appendix N	Some Li-Cor Characteristics V. Szwarc.....	287
Appendix O	Variations in Calibration Factors Computed from Differences in Cosine Response for Kipp and Zonen CM-5 Pyranometers J. McGregor.....	293
Appendix P	Working Document for Pyranometer Discussions Submitted by W. Gillett.....	297
Appendix Q	Pyranometer Calibrations Forwarded by W. Gillett.....	307
Appendix R	Pyranometer Calibration and Characterization Procedures Assembled by C. Wells from work of conference attendees and material of R. Bahm and K. Dehne.....	313
Appendix S	Calibration and Testing of Pyranometers H. Andersson, L. Liedquist, J. Lindblad, and L. Norsten.....	331
Appendix T	Brief Description of Pyranometer Calibration Techniques Used by IEA Participants Compiled by M. Riches.....	385

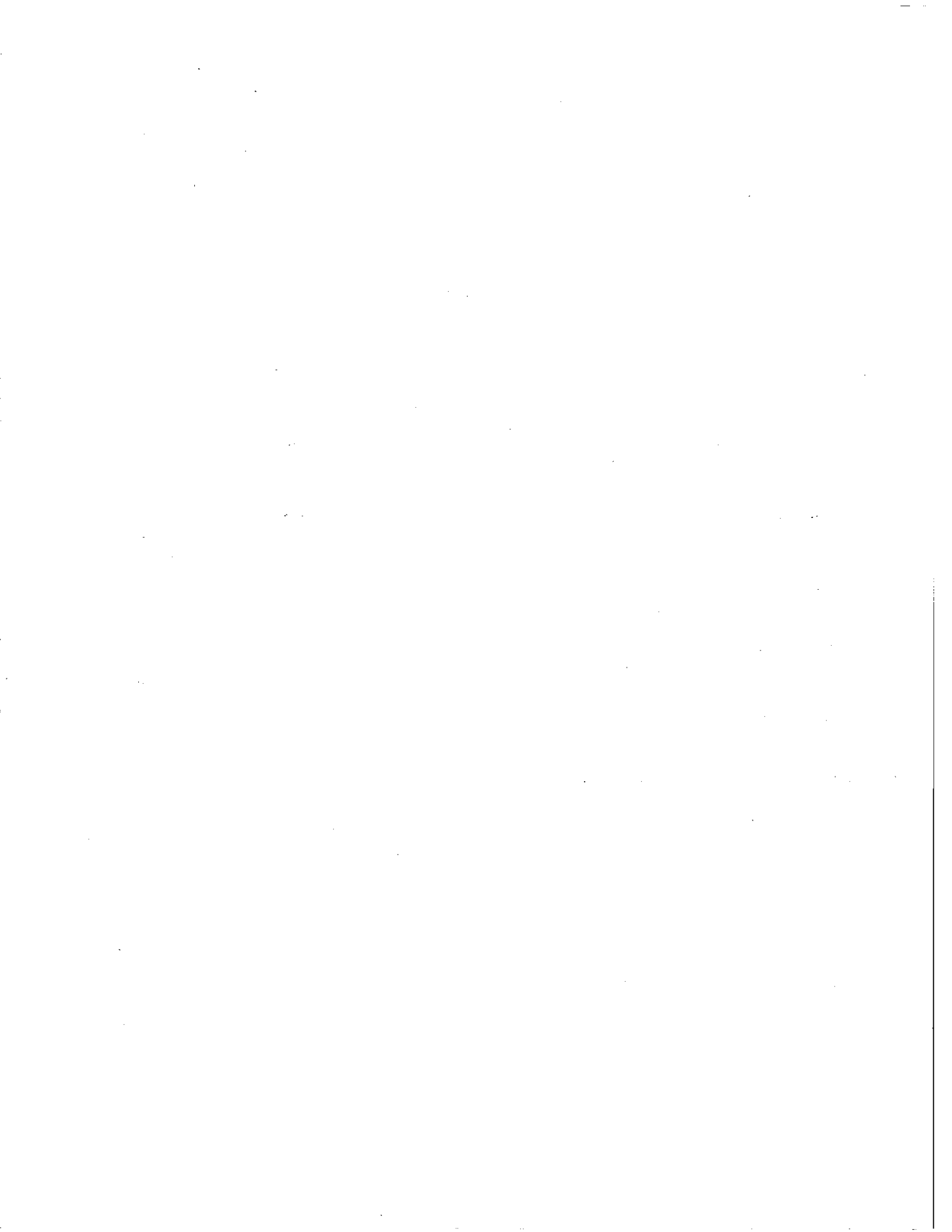

LIST OF FIGURES

	<u>Page</u>
1-1 IEA Task III Round Robin Test Efficiency Data of a Flat-Plate Collector.....	3
1-2 IEA Task III Round Robin Test Efficiency Data of a Flat-Plate Collector.....	3
3-1 Summary of Approach to Goal I.....	16
3-2 Summary of Approach to Goal II.....	21

LIST OF TABLES

	<u>Page</u>
3-1 Round Robin I Instruments.....	17
3-2 Round Robin II Instruments.....	18
3-3 Bench Mark Conditions for Classical Calibration of Pyranometers.....	23

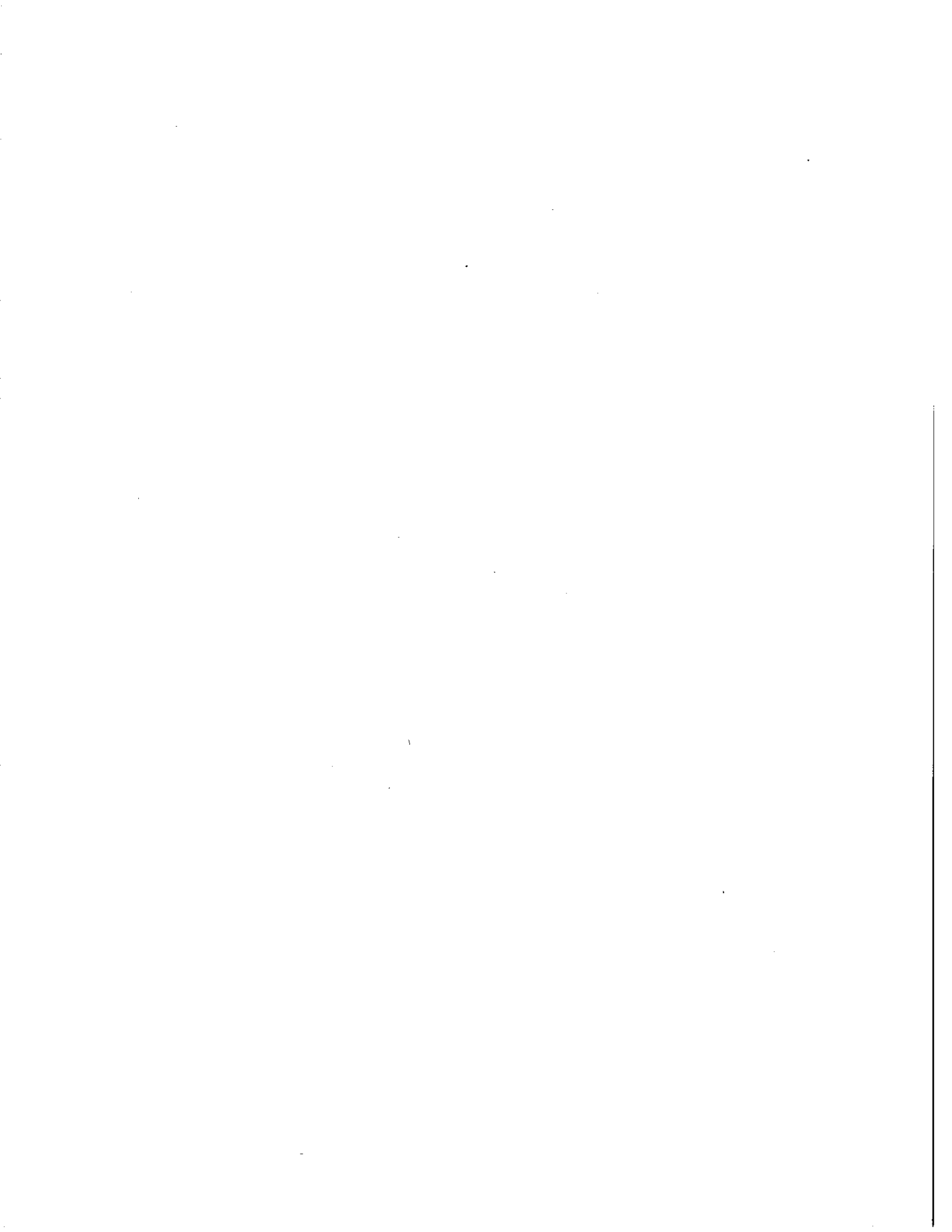

SECTION 1.0

BACKGROUND AND OPENING REMARKS

This section comprises two parts: background information on the reasons for calling the meeting and the opening remarks by Michael R. Riches, who chaired the conference.

1.1 BACKGROUND

Based on a demonstrated need for a coordinated approach to solving energy problems, certain members of the Organization for Economic Cooperation and Development (OECD) agreed to develop an energy program. The International Energy Agency (IEA) was established within the OECD to administer, monitor, and execute the program.

In July 1975, solar heating and cooling was selected as one of several technology fields for multilateral cooperation. The program to develop and test solar heating and cooling systems was divided into project areas (or tasks). Two of the tasks were designated meteorological support tasks for solar heating and cooling research and application. The project areas are

- Task I: Investigation of the performance of solar heating and cooling systems--Denmark
- Task II: Coordination of R&D on solar heating and cooling components--Japan
- Task III: Performance testing of solar collectors--Germany
- Task IV: Development of an insolation handbook and instrument package--United States
- Task V: Use of existing meteorological information for solar energy application--Sweden
- Task VI: Performance of solar heating, cooling, and hot water systems using evacuated collectors--United States
- Task VII: Central solar heating plants with seasonal storage--Sweden.

As part of IEA Solar Heating and Cooling Program's Task III: Performance Testing of Solar Collectors, participants undertook a round robin test program involving several selected collectors in order to compare and evaluate their various collector test procedures. The widely varying results have been reported in IEA Task III reports [1]. Analysis has shown that some of the data scatter resulted from sample variability and variations in test conditions that are allowed under current test procedures. As a result, specifications in the procedures will be tightened. The consensus of the Task III participants was, however, that a significant portion of the remaining scatter was due, not to procedure, but to the instrumentation--most notably the pyranometers used. From the evidence it appeared the pyranometers were introducing inaccuracies two or three times the $\pm 1\%$ levels anticipated from the manufacturers' specifications.

In solar collector testing, pyranometers are employed in circumstances quite different from those in meteorological service. Instantaneous measurements of global irradiance are made at angles of incidence from 0° to about 70° off normal at varying azimuthal angles, with the pyranometer tilted from the horizontal plane by angles up to nearly 90°. Ambient temperature may range from -10°C to +45°C. In currently proposed test procedures, the levels of irradiance must exceed about 650 Wm⁻², with the level of diffuse radiation typically between 5% and 20% of the total. The solar collector tester needs to be sure that the pyranometer employed will indicate the global irradiance to an acceptable level of accuracy (approaching ±1%) despite the variations in circumstances. In almost every case, collector test laboratories now employ the pyranometer calibration constants determined for the instruments by their manufacturers (using procedures developed for meteorological instruments), and accept the manufacturers' specifications and statements of accuracy. Thus, the pyranometers commonly used would introduce an inaccuracy of several percent when used by collector test engineers in modes differing from standard meteorological practices.

In the IEA Report, "Results and Analysis of IEA Round Robin Testing," December 1979 [1], these measurement inaccuracies were assumed for the analysis:

- Solar irradiance, ±3%
- Mass flow rate, ±1%
- Absolute temperature, ±0.5°C
- Temperature differences, ±0.1°C.

In that same document, these conclusions and recommendations were stated:

"The analysis has given an indication that systematic test uncertainties of the testing facilities are a key reason for the scatter of measured collector efficiencies."

"Apart from the analysis conducted, participants have expressed their concern about the uncertainty associated with the accuracy of the pyranometers. The participants had difficulties to ascertain the nominal accuracy of ±3% for their pyranometers."

"International pyranometer standards and calibration methods are needed to provide the individual test facilities with an instrument of known accuracy and precision for collector test purposes."

"The calibration procedure for pyranometers should include performance under tilted position."

The IEA Report [1] contains summaries of the data from testing two types of collectors at 16 laboratories in 12 countries. Figure 1-1 displays the data from testing one of the collector types, showing collector performance data enclosed by the theoretical efficiency curves resulting from meteorological extremes allowed by ASHRAE Standard 93-77 [2]. Figure 1-2 shows the same data with the measurement uncertainty of systematic errors added (approximately ±3%).

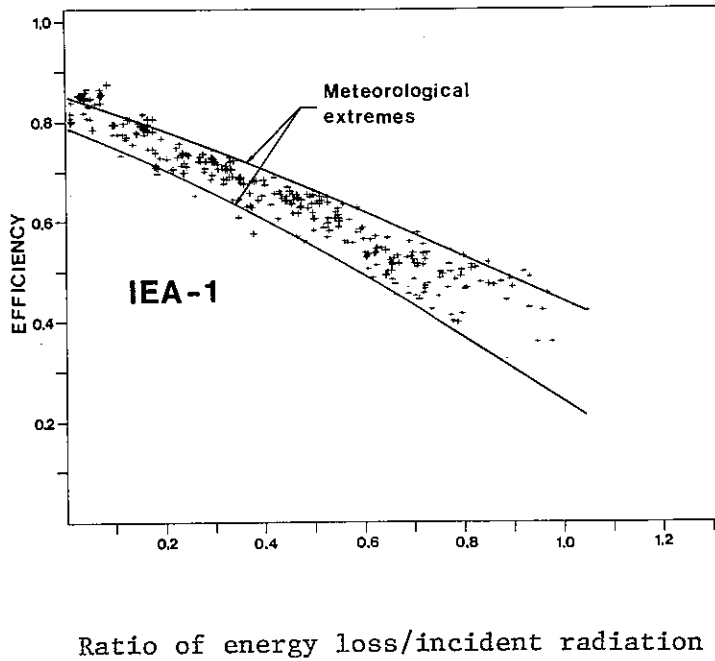

Figure 1-1. IEA Task III Round Robin Test Efficiency Data of a Flat-Plate Collector
 (Scatter of data due to different environmental test conditions.)

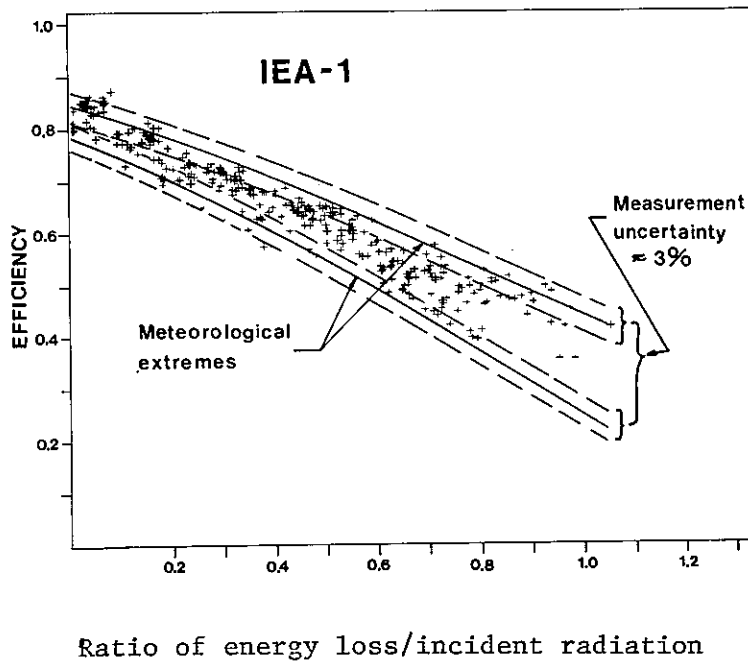

Figure 1-2. IEA Task III Round Robin Test Efficiency Data of a Flat-Plate Collector
 (Scatter of data due to absolute measurement errors.)

If the total uncertainty (limit of error--sum of the errors rather than the RMS of the errors) is to be kept within $\pm 3\%$, then the uncertainty in the solar global irradiance measurements must be brought down to about $\pm 1\%$. Setting a goal of $\pm 1\%$ for the solar global irradiance is proper and reasonable for use in solar collector testing when the sources of error in the other measurements (mass flow rate, temperature and temperature difference, heat capacity of the fluid, reference or aperture area) and the problems of achieving steady-state conditions and working with environmental parameters like wind velocity on the collector are considered.

As a result, the experts involved in collector testing felt very much in need of assistance from the meteorological community. The World Radiation Center (WRC), Davos, Switzerland, readily agreed to host a meeting for the purposes of

- Making the collector test experts more knowledgeable about pyranometry
- Conducting a comparison among the pyranometers they use in collector testing
- Holding face-to-face interdisciplinary discussions concerning the new requirements and implications introduced by solar energy applications.

The results of the Davos meeting are documented in a report distributed shortly afterwards, reproduced as Appendix D in this report. The report stated (p. 12):

"All calibration factors given by the manufacturers yield readings which are 6% to 7% lower than those referred to the World Radiometric Reference (WRR).* Only about 2% can be explained by the difference between IPS and WRR. The remaining 5% seem to be due either to the method of calibration or to the reference instrument used."

This result was considered to be unacceptable and the following actions were recommended (p. 13):

- (1) "Continue such comparisons over extended periods of time and supplement the outdoor comparisons with laboratory measurements of cosine response, temperature coefficients, linearity tests, etc."
- (2) "Urge the manufacturers to review their method of calibration in order to find the reason for the 5% difference."

Though such findings required actions slightly outside of the scope of Task III, the experts from the field of collector testing unanimously agreed to find a solution to the problem. The Executive Committee approved the general approach in October 1980 during the meeting in Ottawa but required

*This statement was later modified by the experimenter to read: "All calibration factors given by the manufacturers yield readings which are 6% to 7% lower than those referred to the Davos Standard Reference Pyranometer." (see also Appendix E)

closer cooperation on the subject between Task III and Task V. Meanwhile the support was confirmed by the Swiss authorities and the manufacturers for an investigation in Davos of the most widely used pyranometers.

The request for stronger assistance of the Task V group by the Executive Committee was answered by the initiation of an Ad Hoc Round Robin (AHRR) test of the Davos instruments. These calibrations were conducted by the Atmospheric Environment Service's National Atmospheric Radiation Centre (AES/NARC) at Toronto, Canada, and by the National Oceanic and Atmospheric Administration's Solar Radiation Facility (NOAA/SRF) at Boulder, Colo., U.S.A., during Winter 1980-81 (Round Robin II).

In addition, a cooperative effort by three laboratories in the United States to compare the calibration constants of these instruments was started immediately after the Davos Meeting (Round Robin I).

The results from these investigations were to be discussed during the Boulder Conference to aid in writing a work statement for comparison tasks and to help Task III in planning for the 1981 test campaign of pyranometers in Davos.

The reader is referred to Appendix B, "Characteristics of Pyranometers," which highlights characteristics which must be considered when working to improve the state of the art of pyranometry. (For other sources of information, see Refs. 3 and 4.)

1.2 OPENING REMARKS (Michael R. Riches, U.S. Department of Energy)

Our meeting has as its primary objective the definition of a statement of work for pyranometer calibration. This simple objective will not be as easy to achieve as to say. That is why we have asked you, the international experts, to participate in the experimental design and the experiment. During the next several days we will hear about two recent pyranometer comparisons and their results, and about the pyranometer comparison experiences of those of you from industry, national, and international calibration laboratories.

From this data base, those of us who must write the statement of work hope to gain insight to design an experiment that accomplishes the following objectives:

- (1) Characterizes the instruments with particular emphasis on solar energy applications
- (2) Compares characteristics such that the solar energy user knows the limits of his sensor and can thus accomplish his overall task more precisely
- (3) Compares and characterizes the calibration methodologies such that solar energy applications are accounted for, and educates the solar energy specialist on these techniques
- (4) Aids communication between the solar energy specialist and the meteorological community.

A key factor for the entire project is time. As the agenda indicates, we must write the Statement of Work here and supply it in late April to the Executive

Committee of the International Energy Agency (IEA). Further, we need to publish our report of this workshop and the results of the experiment in a timely manner. The experiment cannot take years to complete and years to publish. The full schedule cannot exceed two years and, ideally should be completed (including the final report) in 18 months. Such a schedule is possible only if we design a good experiment.

I anticipate that our statement of work will consist of a matrix of instrument characteristics against calibration technique (i.e., measurement procedure, comparison, etc.) and a description (definition) of each parameter specified. (Of course, each participating laboratory would not necessarily take each measurement, e.g., only Canada--of the four proposed labs--has an integrating sphere for calibration.)

As I am one of those responsible for the writing and, therefore, must listen and learn, I suggest we begin our program.

SECTION 2.0

CONFERENCE INSIGHTS, SUGGESTIONS, AND RECOMMENDATIONS

The characterization and calibration of pyranometers is performed in laboratories around the world using a variety of methods and apparatus [5] (also see Appendix R, especially section R.1). The March 1980 Davos comparison of pyranometers (reported in Appendix D) and the subsequent Ad Hoc Round Robins (Appendix C) showed that these different methods do not give exactly the same calibration results. This confirmed the feeling expressed by many solar collector test engineers (and others) privately and in official reports that pyranometry was not performing up to the $\pm 3\%$ nominal accuracy assumed from the manufacturers' literature. This level of accuracy was not adequate for the collector testing programs [1].

This conference gathered some of the leading experts from around the world to focus on the single problem of bringing the pyranometry measurement community into measurement agreement and up to the needed measurement accuracy. There were many insights and suggestions shared, and many recommendations were made. Some of these are gathered and listed here to aid in the reduction of the uncertainties in the absolute value of the measurement and to improve the measurement agreement between laboratories.

2.1 INSIGHTS

The meteorologist and the solar collector test engineer come to pyranometry from different settings, with significantly different needs. The meteorologist, who has for decades been the principal user of pyranometers, desires to measure global radiation on a horizontal plane, for long-term averages and totals (over days, weeks, or years).

The specifications for the instrument have been established for the meteorologist, who generally does not require extreme accuracy (generally 5% is satisfactory). The solar collector test engineer, however, is most interested in instantaneous measurements of global solar radiation on a plane surface that is generally not horizontal.

Since the pyranometer has been utilized principally for the meteorologist's work, the calibration methodology employed was developed to meet this need, and the measurement accuracy was generally satisfactory for meteorological purposes. When the solar collector test engineer utilizes a pyranometer on a tilt, the calibration factor is somewhat in error and inappropriate for the application. In addition, tungsten lamps used for testing often yield different results than testing in sunlight for characterization.

The spectral response of a pyranometer is degraded by exposure to the UV levels present at high altitudes or in the desert, such as at DSET Laboratories near Phoenix, Arizona. Pyranometers which are left continuously in the desert sun show signs of significant degradation in sensitivity after less than one year.

2.2 PYRANOMETER INTERACTION CHARACTERISTICS AND SEQUENCE OF TESTS

Because the various design parameters or operating characteristics of the pyranometer really interact to yield an irradiance measurement, the characterization tests should be performed in a sequence that minimizes the interaction and resulting uncertainties [6]. The results from an earlier characterization test will be needed to improve the accuracy by correcting sources of error later in the characterization process.

Therefore, several individuals felt the following sequence of tests is one possible order which could be followed. The actual sequence selected will be dependent upon the procedure and apparatus utilized for the tests at a given laboratory. Complete documentation of procedures, apparatus, and methods of applying corrections will be a vital part of the process to improve pyranometry. This is the suggested sequence:

1. Response with time
2. Sensitivity
3. Temperature coefficient of sensitivity
4. Thermal transient response
5. Nonlinearity
6. Tilt effect
7. Angular dependence of sensitivity and leveling
8. Spectral response
9. Stability.

It is highly advantageous to complete all indoor laboratory characterization work before beginning the outdoor work. Again, complete documentation cannot be overemphasized as being crucial to the success of improving the designs and applications of pyranometry. In addition, a detailed investigation of possible interactions of the different characteristics has to be a part of the planning of the experiments.

To illustrate the problem and possible solutions, some obvious examples of interaction are listed below for which some corrections are possible. Many other interactions are known and should be carefully documented. Methods need to be developed to reduce their contribution to errors (see Appendix B).

- Adequate time must be allowed for the instrument to respond fully to each change during the characterization tests. Therefore, the time constant should be determined first to avoid errors involving time in all subsequent tests.
- The temperature coefficient of the sensitivity must be determined early in the procedures so that the inevitable changes in the temperature of the instrument and its environment may be taken into account when such tests as nonlinearity, tilt effect, or angular dependence are performed.
- The interdependence of the cosine and azimuth corrections with level and tilt is known to exist. Unfortunately, cosine and/or azimuth corrections

have often been determined on a vertical tilt, because of the apparatus available, so both the tilt effect and its variation with irradiance level may be encountered. Measuring cosine and azimuth corrections on the vertical can be accomplished at low irradiance levels to reduce the tilt effect.

2.3 RECOMMENDATIONS

2.3.1 For a Post-Experiment Round Robin

Following the completion of the data analysis of the March 1980 pyranometer comparison and the subsequent ad hoc round robin tests and of the June-August 1981 Davos experiment, a new post-experiment round robin is recommended. The object would be to establish comparability of pyranometry characterization techniques (by instrument type) used by the national and independent radiometric laboratories that support solar energy and meteorology. National solar energy experts should be encouraged to participate to ensure that solar energy as well as meteorological uses of pyranometers are considered. Specific tests, such as the bench mark tests listed in Table 3-1, can be defined after the efforts defined in Section 3.0 are completed.

2.3.2 For an Education and Dissemination Program

Many individuals commented during the conference on the need for an educational program to better disseminate information on solar radiation measurement techniques and apparatus. The results reported at this Conference and, more importantly, the results from the performance of the Statement of Work and round robins discussed in this report must be brought to the attention of all who make pyranometry measurements.

2.3.3 Working Document by W. B. Gillett

W. B. Gillett of the Solar Energy Unit at University College, Cardiff, Wales, U. K., sent a "Working Document" to the conference via James McGregor. Because the group was in general agreement with Gillett's information and comments, that document is reproduced as Appendix P of this report, together with one correction supplied by John Hickey.

2.3.4 Concerning a Work Statement

The following are some of the recommendations voiced by the conferees before the actual work began on the writing the Statement of Work:

Klaus Dehne--Use four of each type of pyranometer; the Davos Reference Pyranometer should be calibrated again; one must prove the characterization methods by using at least four laboratories.

Otto Motschka--Do not use a reference pyranometer, but use a pyr heliometer for calibrations; send one of each type of pyranometer as part of the round robin--this will also test each meteorological office. Schenk (Ges.m.b.H. Wien & Co. K. G.) can perform polar diagram tests, tilt, temperature coefficient, and linearity tests (the cosine test is done by tilting the instrument).

Bert Peterson--Kipp & Zonen (manufacturer of the CM-2, -6, and -10 pyranometers) can do the polar diagram test as well as tilt, temperature coefficient, and linearity tests.

David Wardle--There should be five types of instruments tested: Schenk, Eppley, K&Z CM-6 and CM-10, EKO; and one or two of each type; test above 30° and at 45° on the normal; do more than one determination of the cosine effect.

Edwin Flowers--Each lab should have 1 to 2 months to test pyranometers; use other labs, particularly the United Kingdom and Sweden; measure and correct for temperature effects; look at both clear and cloudy days; agree ahead of time on modifications, such as changing level and use of ventilation.

Hans Andersson--Fully characterize each type of pyranometer; gain experience from several labs by comparing the methods of characterization.

James McGregor--Round robins are worth doing because they test the differences in procedures used in each individual lab and how these differences represent themselves in final results. We need closer cooperation between those participating in round robins--they need to meet and discuss what they have learned and compare results before going to a larger general meeting. Define the goals of the next round robins. The importance of characterization has been clearly recognized at this meeting and must be a part of any future program. The polar diagram is a necessity because the standard cosine and azimuthal tests are not adequate.

Roger Estey--The reported characterizations are good only in the circumstances tested.

Claus Fröhlich--All involved in comparison should meet together to write draft of report.

Kent Reed--Recommendations for use of pyranometers in collector testing should be made in such a way that we are assured of some delta accuracy, where delta is yet to be defined. Support the hypothesis that a transfer function can be written to correct pyranometer measurements. This can be accomplished with indoor characterizations and outdoor calibrations using well defined standard test methods to calculate an irradiance from the pyranometer output. Don't give up on the ad hoc round robin data--complete the necessary tests to be able to use those results. Send at least six instruments around (1 Schenk, 1 EKO, and three that are at least partially characterized: KFA K&Z, DSET PSP, and NBS PSP); use the test results to resolve the differences from the ad hoc round robins. If it doesn't resolve the differences, we can use the information to improve the characterization process. For complete characterizations include these people and their labs--Dehne, Andersson, McGregor; then calibrate outdoors against pyr heliometer at standard conditions agreed upon. Then place instruments on tilt bar (like SERF's) where they are exposed under

various conditions and see if you get reasonable agreement and see whether, with the information at hand, we can come up with agreement in the results for the irradiance on those instruments at the tilts and various directional exposures. We are just going to have to absorb the discrepancies or the delta number in the goal in collector testing. Careful and very explicit documentation will be needed.

John Hickey--All labs that have the capability to characterize an instrument should be involved; characterization at more than one location is essential because there are site-specific differences which will show up. Arrange at least two duplications of calibrations and performance tests; this may show 1% differences as a function of site, even when using same pyrheliometer and pyranometer. Eppley will do polar diagram test in sunlight--using artificial light gives a different result.

Chester Wells--Do a complete characterization of the ad hoc round robin instruments both before and after this new round robin to settle questions left unanswered in first series of tests, and complete the work started at Davos March 80. Do complete characterizations before and after new round robin with minimum of four new instruments of four types (PSP, CM-10, Schenk, EKO). The manufacturers should characterize the instruments as completely as possible, and then each lab should do the same. The ad hoc round robin documentation should be completed after the characterizations of the instruments are available. A new round robin should involve at least four labs: Davos, Canada, NOAA, and Dehne, with at least one instrument of each type; then the lab people participating should meet together to evaluate the results and develop recommendations for future work. The round robins should tell us what we can expect from using characterizations in the best possible ways by showing characterizations of instruments as families with uncertainties attainable for uncorrected instruments, generic corrections by instrument model, and individual instrument corrections. The final report should contain complete documentation and comparison of characterization techniques. Produce an outline and materials for education program to tell the world what we know about pyranometry.

2.3.5 General Recommendations

The conferees make the following recommendations to the IEA Executive Committee:

- The group as a body of experts recommended that the experiment be of a broader scope than a single-lab experiment--it should be a multi-lab experiment and effort.
- There are national and regional centers (laboratories) associated with WMO and with other organizations which can be used in multi-lab experiments.
- The question and options before the IEA Executive Committee concern whether the sponsorship of the efforts outlined in the Statement of Work (contained in Section 3.0) shall be:
 - By IEA directly

- By IEA co-sponsoring the efforts through national laboratories or through WMO
 - By IEA making direct recommendations to the WMO to sponsor the efforts
 - By some other option or combination of options
- The national solar energy test experts and meteorological experts advising the IEA Executive Committee members need to choose the recommendations for their representatives to support.

SECTION 3.0

STATEMENT OF WORK

3.1 INTRODUCTION

Solar collector performance testing requires solar irradiance measurements approaching a total uncertainty of $\pm 1\%$. From the information presented at the Boulder Conference and the subsequent discussions, pyranometry measurements were clearly not within this limit. This is not to say the commercially available pyranometers were incapable of producing this level of measurement accuracy.

Historically, pyranometers have been used for meteorological monitoring purposes, measuring the solar resource over time scales ranging from hours to years. More rigorous demands are made of pyranometry by collector test applications which, among other things, require nearly instantaneous absolute measures of irradiance. The following issues reflect the differences between these two applications of pyranometers and the manner in which they are calibrated:

- establishing a single value for an instrument calibration factor (a meteorological requirement) which is really the average of a range of calibration factors determined from a variety of test conditions (including those found in collector testing);
- then applying that single factor over a variety of application conditions which are usually different from those of the instrument calibration; and
- finally, using a variety of methods to characterize the nonideal behavior of a pyranometer. Depending upon the method, a different correction value may result for a specific application of the same instrument.

From the data presented at the Conference, it was clear that a more complete and detailed characterization study of each pyranometer used for solar collector performance testing was necessary to achieve the desired $\pm 1\%$ uncertainty in the irradiance measurements. From characterization studies, it may be possible to write an equation for a transfer function that accounts for the nonideal response of a pyranometer to a set of known effects. The transfer function would be used with each instrument, replacing the single calibration factor in the conversion of the pyranometer output signal (typically an electrical potential) to an accurate measure of the radiant power density, i.e., watts per square meter. The characteristics of pyranometers, the concept of the equation for the transfer function, and definitions are discussed in Appendix B.

This section presents the purpose, goals, objectives, and approaches for the Statement of Work developed during the meeting, together with the final products (deliverables) that result from performing the work.

3.2 DEFINITIONS

For the remainder of this discussion, the following definitions are used which, in some instances, have been used interchangeably by other writers.

- Purpose - The general, comprehensive long-range reasons why this project should be considered.
- Goal - A statement expressing a condition or "end-state" to be attained; the long-range result of the work associated with that goal.
- Objective - A clear, simple statement of a target to be reached, which is derived from a goal statement. It is stated in such a way that progress in achieving the goal can be measured.
- Approach - The general method and details (insofar as stated) to be used in achieving the particular objective.
- Products - The final documents and/or other deliverables which result from reaching the stated goals by completing the objectives.

3.3 PURPOSE

The purpose of this effort is to accurately define the present state of the art of pyranometry and then propose improvements to pyranometry methodologies that meet the needs of the solar collector performance test engineers. The necessary improvements to meet these needs are made by applying our present knowledge plus new understanding gained through additional experiments and analyses.

3.4 BRIEF STATEMENT OF GOALS

The following goals were identified during the Conference as aspects of a development program that were necessary to meet the needs of the solar collector performance tester. In brief, the goals are:

- Goal I - The present state of the art of pyranometry will be clearly defined.
- Goal II - Pyranometry measurements will be improved to produce a total uncertainty acceptable for use in solar collector testing based upon proposed methods of calibration and applied results of detailed instrument characterizations.

3.5 FULL STATEMENT OF GOAL I

The state of the art of pyranometry will be clearly assessed and defined as it existed 16 March 1981 using pyranometers involved in the Davos March 1980 comparisons and subsequent Round Robin tests, with calibration methods and apparatus in use at the time.

The following efforts were proposed to accomplish this goal.

3.5.1 Objectives of Goal I

Three identifiable objectives for Goal I are:

- Objective 1.1: Complete the ad hoc Round Robin II comparisons in progress at NOAA/SRF and at AES/NARC.
- Objective 1.2: Provide an interim analysis of the pyranometer characterizations of those instruments involved in the Davos 1980 comparisons and Round Robins I and II as the basis for the design of further experiments.
- Objective 1.3: Summarize the state of the art of pyranometry at the time of the Boulder Conference using available data on those select instruments which participated in the Davos 1980 comparisons and Round Robins I and II.

3.5.2 Approach to Goal I

(A summary of the following information is presented in Figure 3-1.)

3.5.2.1 Complete Round Robin II Testing

To complete the Round Robin II comparisons, NOAA/SRF shall plan the following tests for the months of March and April 1981:

- Determine of the instrument cosine response by means of outdoor shading disk measurement. This will be restricted to the solar elevation angles available at this time of year.
- Determine azimuthal response as tested with a rotating table outdoors.
- Perform temperature response tests in a laboratory chamber over the range of -40° to $+40^{\circ}\text{C}$.
- Perform continuous side-by-side comparisons outdoors to provide calibration factors according to the established SRF methodology described in Appendix H.

NOAA/SRF is testing seven pyranometers that were in the Davos 1980 and RRI comparisons. Additionally, three EKO pyranometers are also being tested. Data collection shall cease and AES/NARC will receive the instruments on or before 1 May 1981.

Depending upon available equipment, all 10 pyranometers will be subjected to the following tests at AES/NARC according to the usual practices:

- Cosine response variations
- Temperature response
- Sphere calibration.

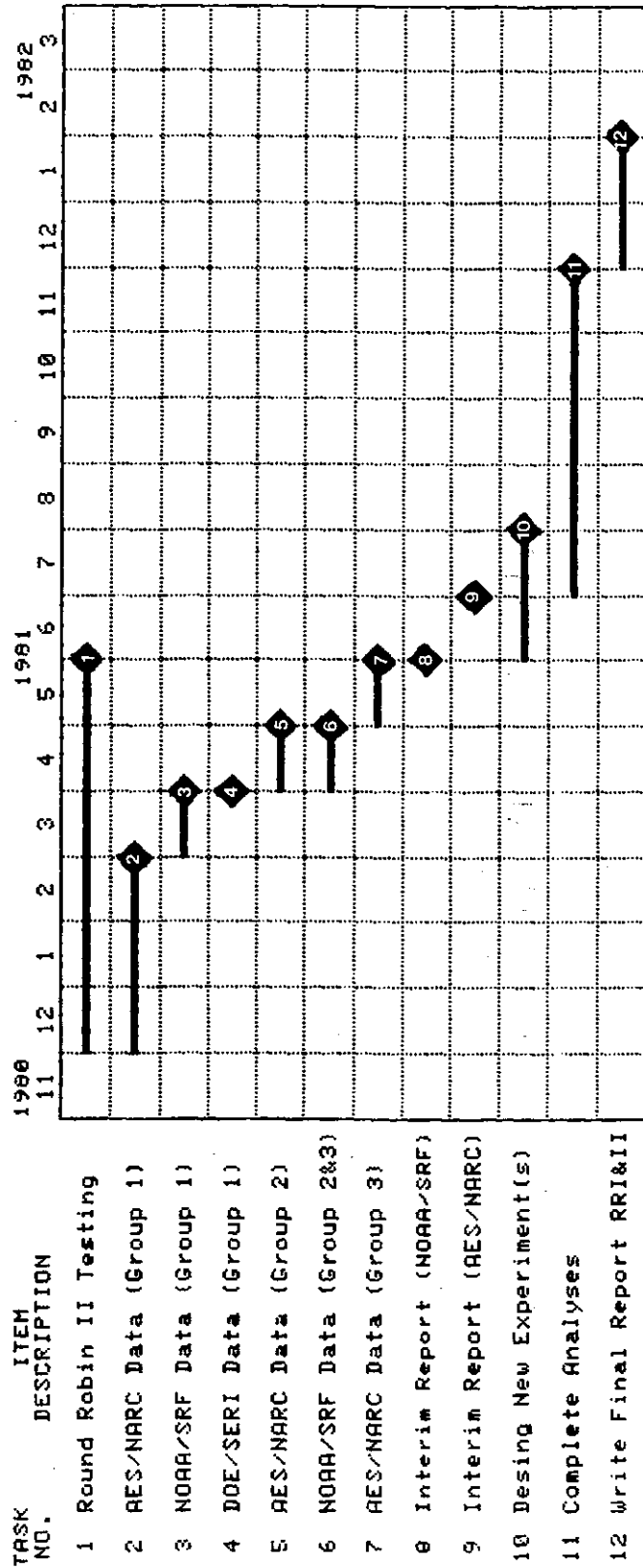

Figure 3-1. Summary of Approach to Goal I

3.5.2.2 Provide an Interim Analysis

NOAA/SRF and AES/NARC shall provide WRC/PMOD and others with preliminary analyses of Round Robin II data for the design of future experiments. Draft forms of separate analyses will be produced as they become available.

The principal investigators will assemble the analyses from the Davos 1980 comparisons and Round Robins I and II into a final document during a meeting tentatively scheduled for October 1981 at NOAA/SRF, Boulder, Colo., USA.

3.5.2.3 Disposition of Pyranometers

The chairman of the IEA Solar Heating and Cooling Program Task III shall arrange for the following instrument logistics:

- Write the owners of the eight pyranometers in Table 3-1 requesting that their instruments continue to be made available for further testing at the NOAA/SRF Boulder, Colo., USA and the AES/NARC Downsview, Ontario, Canada laboratories, and then at the WRC/PMOD facility at Davos, Switzerland. The instruments should be returned to their owners between January and March 1982.
- Write to EKO requesting that their three pyranometers (serial numbers A81901, A81902, A81903) be made available for further testing at Davos following the work performed at NOAA/SRF. An additional unit may also be necessary to perform work under Goal II.

Table 3-1. Round Robin I Instruments

	Owner	Manufacturer	S/N
1.	NBS (U.S.A)	Eppley	14806F3
2.	NRC (Canada)	Eppley	17750F3
3.	Meteorological Office (United Kingdom)	Kipp & Zonen	77-3656
4.	DFVLR (Federal Republic of Germany)	Kipp & Zonen	77-3992
5.	KFA Jülich (Federal Republic of Germany)	Kipp & Zonen	77-4120
6.	Switzerland	Kipp & Zonen	78-5047
7.	Met. Observatory Hamburg (Federal Republic of Germany)	Kipp & Zonen	79-0059
8.	Vienna (Austria)	Schenk	1626

Upon receiving notice from the chairman of Task III, the units will be sent to WRC/PMOD.

- Write the owner of the remaining sensors in Table 3-2 requesting disposition. After receiving notice of the required disposition, the appropriate shipping arrangements shall be made.

3.5.3 Products of Goal I

3.5.3.1 Documentation

Two reports shall be issued as the result of Goal I objectives. Interim analyses for RRII shall be summarized individually by AES/NARC and NOAA/SRF; and final analyses of the Davos 1980 comparisons, Round Robins I and II testing, shall be combined into a single report that documents the state of the art of pyranometry measurement and calibration methods.

3.5.3.2 Characterized Pyranometers

A unique set of instruments will be established as the result of the work done to achieve Goal I. These pyranometers will provide a wealth of information for future investigations.

Table 3-2. Round Robin II Instruments

	Owner	Manufacturer	S/N
1.	Sweden	Eppley	15834F3
2.	Denmark	Eppley	16692F3
3.	KFA Jülich (Federal Republic of Germany)	Eppley	17823F3
4.	DFVLR (Federal Republic of Germany)	Eppley	18978F3
5.	DSET Labs, Inc. (U.S.A)	Eppley	19129F3
6.	Stuttgart (Federal Republic of Germany)	Kipp & Zonen	75-2438
7.	Switzerland	Kipp & Zonen	76-3000
8.	Belgium	Kipp & Zonen	78-4750
9.	University College Cardiff (United Kingdom)	Kipp & Zonen	80-7177
10.	Netherlands	Kipp & Zonen	80-0077

3.6 FULL STATEMENT OF GOAL II

GOAL II - The state of the art of pyranometry will be improved to produce measurements of global solar radiation on any defined plane surface, oriented from the horizontal to the vertical with a total uncertainty acceptable for use in solar collector testing and other solar engineering applications.

3.6.1 Objectives of Goal II

The following objectives have been selected to achieve Goal II. At least three inputs will have a significant role in the design of the experiment: the interim working definition of the state of the art of pyranometry; the concept of testing an hypothesis; and a set of measurement goals for pyranometry.

If the experiment is to be successful and is to provide maximum future benefit, very complete documentation and reporting is essential. Pyranometry will be improved through these dissemination efforts and application of the new knowledge.

3.6.1.1 Objective 2.1

The detailed design of a comprehensive experiment will be completed. The experiment will be conducted at WRC/PMOD (Davos, Switzerland) and other laboratories as necessary and practical. The design of the experiment shall incorporate:

- the knowledge and information expressed in the interim working definition of the state of the art of pyranometry (from Goal I, Objective 1.2);
- the concept of testing an hypothesis (that an equation for a transfer function can be formed and be applied to improve pyranometry); and
- the design for the experiment shall start from the end result desired (the stated measurement goals) and be adequate to meet those goals.

The experiment design shall provide for the test of an hypothesis that can produce a useable equation for the transfer function, and that has adequate methods (or methods can be easily developed) to determine the coefficients sufficiently well to produce uncertainties, precision, and measurement agreement within experimental limits.

The design shall provide criteria to test a methodology and criteria to select and apply widely available pyranometers based on required accuracy under three levels of correction. The correction techniques will be evaluated using bench-mark tests.

The final experiment design shall be adequate to test the ability of pyranometers to produce measurements of global solar radiation (on any defined plane surface oriented from the horizontal to the vertical) with a total uncertainty not exceeding $\pm 1\%$, a precision (repeatability) of at least $\pm 0.1\%$, and measurement agreement between different laboratories of $\pm 0.5\%$. All characterization tests (and cross-design) necessary to reach these measurement

goals shall be considered in the design. The design shall also provide for all of the information necessary to produce the features specified under the Products of Goal II (see Sec. 3.6.3).

3.6.1.2 Objective 2.2

Each manufacturer shall characterize (as completely as facilities permit) each new pyranometer supplied to this program, and shall supply the calibration factor routinely provided for his customers.

3.6.1.3 Objective 2.3

The experiment will be conducted at the World Radiation Center (WRC/PMOD), Davos, Switzerland and other laboratories as required to accomplish the work designed in Objective 2.1. The experiment shall test the hypothesis that an equation for the transfer function can achieve the measurement goals stated earlier by utilizing pyranometer characterizations performed by the manufacturers, in the round robin testing, and at WRC/PMOD and other European laboratories.

Bench mark and other tests shall be performed to test the methodology and criteria proposed for the selection and application of pyranometers on the basis of required accuracy and three levels of correction.

All characterizations, tests, and measurements shall be performed adequately to achieve the total uncertainty not exceeding $\pm 1\%$, a precision of $\pm 0.1\%$, and measurement agreement between laboratories of $\pm 0.5\%$.

3.6.1.4 Objective 2.4

Develop an interim procedure, a methodology (specifically to aid pyranometer users in the selection and application of pyranometers), the determination and application of corrections for widely available pyranometers, and the extent to which corrections need to be applied on the basis of the degree of uncertainty needed for the intended application (up to the limits of the state of the art).

3.6.2 Approach to Goal II

A timetable for accomplishing Goal II is presented in Figure 3-2. The tests will be performed at WRC/PMOD (Davos, Switzerland) and at other laboratories in Europe as required and as time permits further testing.

3.6.2.1 Old Instruments to be Tested

The following instruments took part in the March 1980 Davos Comparison and will be used in Round Robins I and II:

- Eppley PSP, Serial Numbers 14806, 17750;

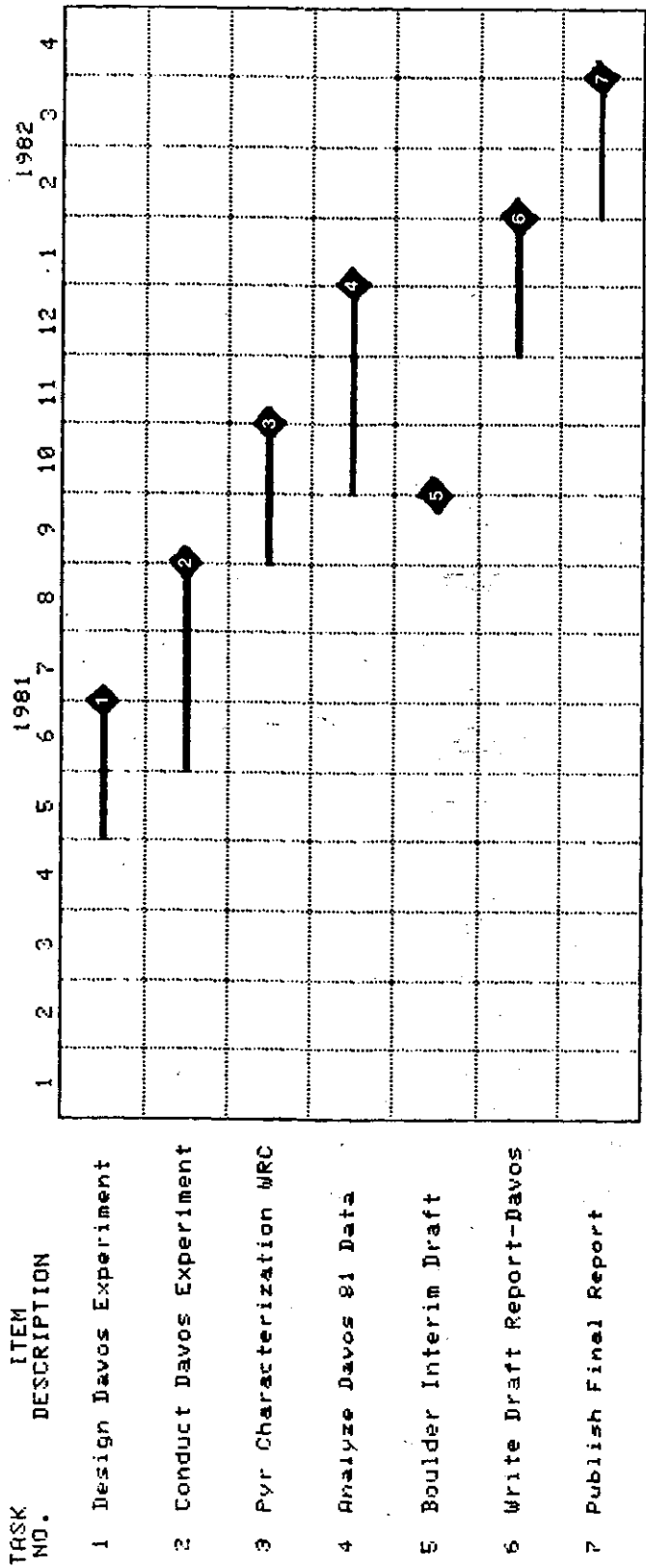

Figure 3-2. Summary of Approach to Goal II

- Kipp & Zonen CM-6, Serial Numbers 773656, 773992, 774120, 785047;
- Kipp & Zonen CM-10, Serial Number 790059; and
- Schenk Star, Serial Number 1626.

The instruments which are now at NOAA and SERI will be tested at NOAA in April 1981 and at AES/NARC in May 1981 before being returned to Davos for inclusion with the new instruments.

The instruments at NOAA will be characterized and calibrated for cosine, azimuth, and temperature corrections, and in outdoor calibrations. The instruments at AES/NASRC, will be characterized for cosine and temperature errors and given a sphere calibration. This work will be accomplished within the limitations set by time of year, time, and weather.

3.6.2.2 New Instruments to be Tested

The manufacturers will supply 16 new instruments. Each manufacturer will test the new instruments for angular response (cosine, azimuth), temperature coefficient and response, linearity, effects of tilt, and other tests for which he has the capability. He will also perform a calibration in the manner normally employed for his usual customer.

The new instruments will consist of four models of the Eppley PSP, Kipp & Zonen CM-10, Schenk Star, and EKO Star.

3.6.2.3 Tests at Davos

All instruments, those planned for the new experiment and those involved in previous tests, will be completely characterized at WRC/PMOD and in other laboratories as necessary and as time permits. These characterizations shall include, but are not limited to:

- Temperature coefficient of sensitivity as a function of ambient temperature over at least the range from -30°C to $+50^{\circ}\text{C}$;
- Time response and thermal transient response behavior;
- Departure from linear response of output to input over the irradiance range from 50 to 1500 W/m^2 ;
- Angular dependence of sensitivity (cosine and azimuth). The beam shall be composed of parallel rays and of spectral quality approximating that of the sun. Special tests shall be performed to ensure that the results are not biased because of the spectral content of the light source(s) used.
- Response as a function of angle of tilt from the horizontal at orientations from the horizontal to the vertical.
- Sensitivity, using shading disc and other techniques as appropriate.

**Table 3-3. Bench mark Conditions for Classical Calibration of Pyranometers:
Control Conditions for Pyranometer Sensitivity Specification**

Parameter	Standard 1	Standard 2
Tilt	Horizontal	50° from horizontal, towards the sun
Rotation	*Reference direction in the solar azimuth plane pointing toward the sun (i.e., downward)	*Reference direction in the solar azimuth plane pointing towards the sun (i.e., downward)
Solar Elevation	35°	40° (i.e., pyranometer at normal incidence)
Direct Intensity (pyrheliometer reading)	900 W/m ²	900 W/m ²
Temperature	15°C	15°C
Ventilation	As described by tester	As described by tester

*Instrument orientation can be defined by the position of the signal cable connector. Complete documentation must be provided for all tests, including instrument orientation.

The selected temperature is predicated by the climatic limitations anticipated during these outdoor tests at the participating labs.

The instruments are to be tilted with the cable toward the sun to avoid water accumulating in the connectors.

The emphasis of the work is to be placed on instantaneous irradiance measurements as needed by solar collector test engineers, not on long-term integrated averages. However, all instrument data will be compared for extended periods (days) as time permits to include cloudless, partly cloudy, and overcast (both low and high overcast) sky conditions. Specific bench mark standard conditions are presented in Table 3-3 for comparison purposes; additional standard conditions may be added as deemed appropriate.

Reference irradiance measurements of documented accuracy will form the basis for all comparisons. The reference measurements shall come from the corrected readings from the WRC/PMOD Reference Standard Pyranometer or other highly characterized pyranometer; and the combined measurements of an absolute pyrheliometer (direct component) and a corrected, shading disc pyranometer (diffuse component).

The measurement periods, in addition to the instantaneous measurements, will be for complete days (sunrise to sunset) and for different times of the year to cover a wide range of temperatures and combinations of elevations/azimuths of the sun. The outdoor measurements will also include periods of whole days at various tilt angles and for various times of the year to include a variety of ground surfaces from grass to snow. (The latter are important to verify corrections for the different types of detectors, i.e., black and white or all black.)

3.6.2.4 Data Analysis

The data analysis should compare results from uncorrected with corrected measurements. The uncorrected measurements would be obtained by using only the factory supplied single value calibration factor. The corrected measurements shall be presented as the results of single errors (e.g., temperature alone, cosine alone, other) and combined errors so as to present the range of accuracies that can be obtained and the relative importance of the various sources of error. These corrections to single value calibration factors shall be compared to the errors which are corrected by the transfer function method.

Different cloudiness conditions shall be considered separately to illustrate the efficacy of the correction procedures for various cloud conditions.

The results of the analysis shall clearly show the accuracies that may be obtained when considering instrument errors separately and combined for each of the measurement data sets and for each type of pyranometer. This would allow the user to choose how much correction he wishes to apply on the basis of the desired accuracy and according to the conditions and type of instrument to be employed in the particular application.

3.6.3 Products of Goal II

At least four products will result from the effort to achieve Goal II: A final report; a special stand-alone section of the final report that can serve as a handbook on pyranometry measurements; a group of pyranometers with the best possible characterization and correction information; and an experiment test plan.

3.6.3.1 Final Report

A detailed final report shall be prepared containing these features:

- the data from the tests and experiments;
- the analysis of the data;
- the results of the benchmark tests;
- a discussion of the methodology and criteria for the selection and application of pyranometers on the basis of the required accuracy and specific applications; and
- the results of testing the transfer function hypothesis.

3.6.3.2 Handbook

A special feature of the final report shall be a stand-alone section of the report which could serve as a handbook on pyranometry measurements. This handbook shall contain a detailed discussion of a methodology and criteria for selecting and applying widely available pyranometers on the basis of the required accuracy and specific intended applications. The methodology shall be appropriate for three measurement correction levels:

- "uncorrected", using the normal factory supplied or local laboratory determined, single-value calibration factor;
- "generic corrections", that can be applied to all instruments of a particular model, where the degree of correction and uncertainty in its application have been ascertained from testing a large number of instruments of the model; and
- "individual corrections" at two levels:
 - correcting the single-value calibration factor for such errors as temperature coefficient, cosine, azimuth, or tilt response, applied singularly or in various combinations; and
 - using an equation for the transfer function that accounts for all the parameters significantly affecting the output of the pyranometers.

This section shall specifically address these items:

- all characteristics which have any significant (measureable) effect on the pyranometer output and performance;
- definitions of those characteristics;
- the methods available to measure these characteristics, a discussion of the recommended procedures with accuracies achievable, and the resultant improvements possible in affecting pyranometry;
- the actual equation for the transfer function which was tested, and how to determine and apply the coefficients;
- the results achieved for the three levels of corrections when applied to these pyranometers: Eppley PSP, Kipp & Zonen CM-5/6 and CM-10/11, Schenk Star, and EKO Star; and
- an error budget for each of the above pyranometers, and how the total error figure was derived.

If the $\pm 1\%$ absolute uncertainty is not reached, a complete analysis shall be presented to explain why that uncertainty was not possible with the techniques used. Recommendations shall be given for achieving the desired $\pm 1\%$ uncertainty.

3.6.3.3 Characterized Pyranometers

The pyranometers which have been used in these extensive tests and round robin tests will be the best characterized instruments in existence. They are an

important resource to the field of pyranometry, especially for determining the measurement agreement between laboratories.

3.6.3.4 Experimental Test Plan

The test plan will serve as an excellent guide for future efforts to further improve pyranometry if necessary, or for other related experimental work.

3.7 BENEFITS FROM ACHIEVING GOALS I AND II

The benefits which will result from achieving Goals I and II are:

- the true state of the art of pyranometry will be known;
- the methodology to achieve state-of-the-art pyranometry measurements will be well documented and tested;
- recommendations will be available to show how to further improve pyranometry, to obtain a $\pm 1\%$ uncertainty if not achieved initially by this work, or how to achieve further improvements if required in the future; and
- pyranometers will be available that are very well characterized and are most suitable for further round robin testing, especially for the need to assure continued measurement agreement between various laboratories.

3.7.1 Knowledge of the State of the Art of Pyranometry

The solar collector test engineer will be able to assign realistic uncertainties to the global radiation measurements with the understanding of pyranometry principles and practices relevant to his needs. This will free their attention for solving the next level of test and measurement problems.

3.7.2 A Methodology for Achieving State-of-the-Art Pyranometry Measurements

A proven methodology for achieving the best possible measurements with currently available pyranometers will save considerable time and effort in laboratories. These new methods, once implemented in various laboratories, will allow solar collector test engineers to quickly and accurately compare collector performance.

Better methodology for pyranometry measurements will make it possible to:

- assign truly realistic and known values of uncertainty to the collector test data;
- compare much more adequately the measurements made today with those made in the past and those to be made in the future. It is particularly important to be able to confidently measure small changes when engaged in development efforts to improve a product or compare two products, or when studying the degradation of a product with time or other influences; and

- compare measurements from different laboratories and know the actual uncertainties in that comparison.

3.7.3 Recommendations to Achieve Improvements in Pyranometry

If the $\pm 1\%$ total uncertainty goal for pyranometry is not achieved, or if further improvements become necessary in the future, the insights gained and documented will be useful for procuring those improvements.

3.7.4 Well-Characterized Pyranometers

This work should produce a set of the best characterized pyranometers known to exist. These pyranometers will be a valuable resource for making periodic checks on the measurement agreement between laboratories. The advances in pyranometry through this effort will be conserved and affirmed only with continued checks with such pyranometers.

3.7.5 Summary

These recommendations are offered to conserve the progress made in pyranometry through the efforts outlined in the Statement of Work.

- The procedures and methodology developed should be recommended to all instrument manufacturers, and meteorological instrument calibration laboratories.
- The concepts proven here should be incorporated into new, uniform procedures and standards.
- Round robins in pyranometry should be conducted periodically as Measurement Agreement or Measurement Assurance Programs (MAPs).
- An education and dissemination program must begin immediately to make these advances in pyranometry measurements known.

SECTION 4.0

REFERENCES

1. Talarek, Horst D., editor. 1979 (Dec.). Results and Analysis of IEA Round Robin Testing: Document III.A.1 Kernforschungsanlage Jülich GmbH. Jülich, Federal Republic of Germany; 62 pp.
2. American Society of Heating, Refrigerating and Airconditioning Engineers. 1977. Methods of Testing to Determine the Thermal Performance of Solar Collectors; ASHRAE Standard 93-77. New York: ASHRAE.
3. Fritschen, Leo J.; Gay, Lloyd W. 1979. Environmental Instrumentation. New York: Springer-Verlag; 232 pp.
4. Coulson, Kinsell L. 1975. Solar and Terrestrial Radiation. New York: Academic Press, Inc.; 333 pp.
5. Bahm, Raymond J.; Nakos, John C. 1979. The Calibration of Solar Radiation Measuring Instruments. Albuquerque, NM: The Bureau of Engineering Research, University of New Mexico; 236 pp.
6. Dehne, Klaus. 1981. "Unpublished Submittal to the International Energy Agency Conference on Pyranometer Measurements." Boulder, CO, USA; 16-20 March 1981.

BIBLIOGRAPHY

- American Institute of Physics. "Radiometry: Selected Reprints." New York: American Institute of Physics.
- American Society of Heating, Refrigerating, and Airconditioning Engineers. 1977. Method of Testing Thermal Storage Devices Based on Thermal Performance; ASHRAE Standard 94-77. New York: ASHRAE.
- American Society of Testing and Materials. 1980. Subcommittee E44.02 has three draft standards under development and review: DD 102R1/E44.02, "Calibration of Secondary Reference Pyrheliometers and Pyrheliometers for Field Use"; DD 103R0/E44.02, "Transfer of Calibration from Reference to Field Pyranometers"; and DD 104R0/E44.02 "Calibration of Reference Pyranometers by the Shading Method."
- Bertram, R. W. 1980 (Aug.). Testing and Standards for Thermal Solar Collectors. Presented at the 1980 International Symposium on Solar Energy Utilization. Aug. 1980.
- Coudert, Plazy. Estimation des Incertitudes Lors de l'Etalonnage des Pyranometres. Results of International Pyrheliometric Comparisons at Davos, Switzerland 1980 (in press).
- Coulson, Kinsell L. 1975. Solar and Terrestrial Radiation: Methods and Measurements. New York: Academic Press; 322p.
- Dehne, Klaus. Results of Indoor Tests of Solarimeter Specifications (CM-6 & CM-10). Results of International Pyrheliometric Comparisons at Davos, Switzerland 1980 (in press).
- Flowers, Edwin C. NOAA Solar Radiation Standards, Results of International Pyrheliometric Comparisons at Davos, Switzerland 1980 (in press).
- Goldberg, Bernard. 1980. Errors Associated with Precision Pyranometer on a Tilted Surface. Technical Note, Solar Energy. Vol. 25: p. 285.
- Hickey, John R. 1975. "Solar Radiation Measuring Instruments: Terrestrial and Extraterrestrial." Society of Photo-Optical Instrumentation Engineers Journal. Vol. 68: p. 53.
- Hill, A. N.; Latimer, J. R.; Drummond, A. J.; Greer, H. W. 1966. "Standardized Procedures in the North American Continent for the Calibration of Solar Radiation Pyranometers." Solar Energy. Vol. 10 (4): pp. 1-11.
- Jimenez, J. I.; Romeu-Nedwed, C.; Liebot, J. E.; Casas-Vasquez, J. Plane Incident Solar Radiation Effects of Slope and Orientation. Solar Energy - International Progress.
- Justin, B.; Pye, D. B. 1980. "Measurement of Solar Irradiance on a Tilted Surface." Proceeding of the 1980 Annual Meeting of the American Section of the International Solar Energy Society. Vol. 32; pp. 2219-2221.

- Klein, W. H.; Hickey, J. R. 1974. Proceedings of the Symposium on Solar Radiation Measurements and Instrumentation. Rockville, MD; 13-15 Nov. 1973. Radiation Biology Laboratory, the Smithsonian Institution.
- Latimer, J. Ronald. 1972. Radiation Measurement, International Field Year for the Great Lakes Technical Manual, Series No. 2. Ottawa, Canada: the Secretariat, Canadian National Committee for the International Hydrological Decade.
- Liu, B. Y. H.; Jordan, R. C. 1960. "Interrelationships and Characteristic Distribution of Direct, Diffuse, and Total Solar Radiation." Solar Energy. Vol. 4: pp. 1-19.
- Lunde, Peter J. 1980. "Elevation of Monthly Average Global Radiation Data from a Horizontal to a Tilted Surface." Proceedings of the 1980 Annual Meeting of the American Section of the International Solar Energy Society. Vol. 3.2; pp. 1392-1396.
- Murcra, David G.; Kusters, John J. 1975. "Problems in Solar Irradiance Measurements." Society of Photo-Optical Instrumentation Engineers Journal. Vol. 68; pp. 49-52.
- National Oceanic and Atmospheric Administration. 1977. Solar Radiation Observations, National Weather Service Observing Handbook No. 3. Silver Spring, MD: U.S. Department of Commerce, NOAA/NWS, Data Systems Division.
- Nicodemus, F. E., ed. 1976. Self Study Manual on Optical Radiation Measurements. National Bureau of Standards Technical Notes 910. Part I--Concepts (in 4 volumes).
- Temps, R. C.; Coulson, K. L. 1977. "Solar Radiation Incident Upon Slopes of Different Orientations." Solar Energy. Vol. 19, pp. 174-184.
- Thekaekara, M. P. 1976. "Solar Radiation Measurements; Techniques and Instrumentation." Solar Energy. Vol. 18; p. 309.
- Thekaekara, M. P.; Collingbourne, R. H.; Drummond, A. J. 1972. "Comparison of Working Standard Pyranometers." Bulletin of the American Meteorological Society. Vol. 53 (1): pp. 8-15.
- U.S. Department of Energy. 1977. DOE Facilities Solar Design Handbook. DOE/AD-0006/1. ERDA 77-65.
- World Meteorological Organization. 1965. Guide to Meteorological Instrument and Observing Practices. 2nd edition. WMO-No. 8. TP.3.

APPENDIX A

**Attendance List
and Agenda**

ATTENDANCE LIST

- | | |
|---|---|
| <p>1. Hans Andersson
National Testing Institute
Physical Measurements
Box 857
S-501 15
Boras, Sweden</p> | <p>Tel: 46 33 10 20 00
Telex: 36252</p> |
| <p>2. Lars Dahlgren
Swedish Meteorological &
Hydrological Institute
Box 923
S-601 19 Norrkoping,
Sweden</p> | <p>Tel: 011/10 80 00
Telex: 644 00 smhi s</p> |
| <p>3. Klaus Dehne
Deutscher Wetterdienst
Met Observatorium Hamburg
Framredder 95
D-2000 Hamburg 65
Federal Republic of Germany</p> | <p>Tel: 040/601-7924</p> |
| <p>4. Roger S. Estey
Jet Propulsion Laboratory
4800 Oak Grove Drive
Pasadena, CA 91103
U.S.A.</p> | <p>Tel: 805/964-6153</p> |
| <p>5. Edwin C. Flowers
National Oceanic & Atmospheric
Administration
Solar Radiation Facility R32X2
325 Broadway
Boulder, CO 80303
U.S.A.</p> | <p>Tel: 303/497-6662</p> |
| <p>6. Claus Fröhlich
Physico-Meteorological Observatory
P.O. Box 173
CH-7260 Davos Dorf
Switzerland</p> | <p>Tel: 083/5 21 31
Telex: 74732 pmod ch</p> |
| <p>7. Martin Hanson*
Li-Cor, Inc.
P.O. Box 4425
Lincoln, NE 68504
U.S.A.</p> | <p>Tel: 402/467-3576</p> |

*Observer

8. John Hickey
The Eppley Laboratory, Inc.
12 Sheffield Ave.
Newport, RI 02840
U.S.A. Tel: 401/847-1020
9. Roland L. Hulstrom*
Solar Energy Research Institute
Renewable Resource Assessment
and Instrumentation Branch
1617 Cole Blvd.
Golden, CO 80401
U.S.A. Tel: 303/231-1220
Telex: TWX 910 937-0738
wlsoqgldn
10. James McGregor
Solar Energy Unit
Department of Mechanical Engineering
and Energy Studies
University College, Newport Road
Cardiff, Wales
United Kingdom Tel: 0044 211 7041
Telex: 49635
11. Otto Motschka
Zentralanstalt Meteorologie v.
Geodynamik
Hohenwarte 38
A-1190 Wien
Austria
12. Daryl Myers
Solar Energy Research Institute
Renewable Resource Assessment
and Instrumentation Branch
1617 Cole Blvd.
Golden, CO 80401
U.S.A. Tel: 303/231-1849
Telex: TWX 910 937-7038
wlsoqgldn
13. Bert Peterson
Kipp en Zonen
Mercuriusweg No. 1
Delft
Holland
14. Kent Reed
National Bureau of Standards
Building 226, Room B304
Washington, DC 20234
U.S.A. Tel: 301/921-2640

*Observer

15. Michael R. Riches
U.S. Department of Energy
Office of Energy Research ER-12
Washington, DC 20545
U.S.A. Tel: 301/353-3281
Telex: TWX 710 822-9249
16. Val Szwarc
Solar Energy Research Institute
Renewable Resource Assessment
and Instrumentation Branch
1617 Cole Blvd.
Golden, CO 80401
U.S.A. Tel: 303/231-1816
Telex: TWX 910 937-0738
wlsoqgldn
17. Thomas L. Stoffel
Solar Energy Research Institute
Renewable Resource Assessment
and Instrumentation Branch
1617 Cole Blvd.
Golden, CO 80401
U.S.A. Tel: 303/231-1814
Telex: TWX 910 937-0738
wlsoqgldn
18. Horst D. Talarek
Solar Energy Branch/IKP
Kernforschungsanlage Jülich
Postfach 1913
D-5170 Jülich
Federal Republic of Germany Tel: 02461/614640
Telex: 833 556 kfa d
19. David I. Wardle
National Atmospheric Radiation Centre
Atmospheric Environment Service
4905 Dufferin St.
Downsview, Ontario M3H 5T4
Canada Tel: 416/667-4834
Telex: 06-964 582
20. Chester Wells
Solar Energy Research Institute
Renewable Resource Assessment
and Instrumentation Branch
1617 Cole Blvd.
Golden, CO 80401
U.S.A. Tel: 303/231-1981
Telex: TWX 910 937-0738
wlsoqgldn
21. Gene Zerlaut
DSET Laboratories, Inc.
Box 1850
Black Canyon Stage
Phoenix, AZ 85029
U.S.A. Tel: 602/465-7356
Telex: TWX 910 950-4681
dset phx

AGENDA

IEA Solar Heating & Cooling Program Tasks III & V

Pyranometer Comparison Planning Meeting

16-20 March 1981

Monday

- | | | |
|-------|---|----------------------------------|
| 08:30 | Introductory Remarks
Welcome
Problem Overview and Statement of Goals | SERI Representative
M. Riches |
| 09:00 | Final Report of Davos Comparison Held
March 1980 | C. Fröhlich |
| 10:30 | Break

The next three reports are summaries of the
DSET/NOAA/Eppley comparisons of three
pyranometers involved in the Davos
measurements of March 1980 | |
| 11:00 | DSET Labs Report | G. Zerlaut |
| 12:30 | Lunch | |
| 13:30 | NOAA Report | E. Flowers |
| 14:00 | Eppley Report | J. Hickey |
| 14:30 | Discussion | |
| 15:00 | Break | |
| 15:30 | Tour of NOAA Solar Radiation Facility | |
| 17:00 | Adjournment | |

Tuesday

- | | | |
|-------|--|-----------------------------|
| 08:30 | Background to Second Comparison of IEA
Pyranometers | M. Riches and
H. Talarek |
| 09:00 | Results of Tests Performed by AES | D. Wardle |
| 10:30 | Break | |
| 10:45 | Results of Tests Performed by NOAA | E. Flowers |
| 12:00 | Lunch | |

Tuesday (continued)

- 13:30 Results of Tests Performed by SERI T. Stoffel
- 14:30 Discussion
- 15:00 Break
- 15:30 Summary of Combined Results of the Three Experiments: Implications for Future Comparison Document
- 17:00 Adjournment

(A group dinner, "dutch-treat", is planned for 19:30 at the Flagstaff Inn)

Wednesday

- 08:30 Discussions of Future Pyranometer Comparison Efforts: Why Must the Process Continue and What Must be Accomplished to Satisfy Task III Needs? M. Riches
H. Talarek
- 09:30 What Should be in the Detailed Work Statement? (number of instruments, test period(s), data analysis, etc.)
- Informal Presentations by (but not restricted to)
- C. Frohlich E. Flowers J. Hickey D. Wardle
H. Talarek G. Zerlaut L. Dahlgren (others)
- 11:00 Scheduling the Round Robin Comparisons at AES, NOAA, WRC, and One Other European Site H. Talarek
- 12:30 Lunch
- 13:30 Open Discussions of Work Statement Contents
- 15:00 IEA Principle Members Draft Document Using Input from Attendees H. Talarek,
L. Dahlgren,
M. Riches

Note: During the course of this day's activities, the basic content of the work statement will be decided. Using some materials prepared before the meeting (i.e., previous comparison report summaries and Data Sheet information), the document should contain an introduction, discussions pertaining to the Data Sheet, details of the comparison/characterization, and appendices containing supporting documentation.

Thursday

- 08:30 Review Draft Document as Prepared
- 10:30 Prepare Final Draft Document to be Presented to
the Executive Committee (28-29 April 1981)

Note: M. Riches and T. Stoffel will prepare
this draft.

Friday

- 08:30 Assemble at NOAA in Boulder for Travel to SERI
(Golden is about 40km distant.)
- 09:30 Tour of SERI Laboratories
- 11:00 Tour of SERI Field Test Site
- 12:00 Lunch
- 13:30 Visit South Table Mountain Remote Monitoring
Station
- 14:30 Visit Area Demonstration Project (to be determined)
- 16:00 Return to NOAA (Boulder)
Receive Copy of Final Draft of the Work Statement

Note: Any changes to the document after this time
must be made by Telex on or before 27 March,
to be included in the 28-29 April Executive
Committee Meeting.

The Telex Number for SERI is: 910 937-0738.
Please ask for Tom Stoffel, 642, 16/3

APPENDIX B

Characteristics of Pyranometers

by

Hans Andersson
National Testing Institute
Physical Measurements
Box 857
S-501 15
Boras
Sweden

Klaus Dehne
Deutscher Wetterdienst
Met Observatorium Hamburg
Framredder 95
D-2000 Hamburg 65
Federal Republic of Germany

Roger Estey
Jet Propulsion Laboratory
4800 Oak Grove Drive
Pasadena, California 91103
U.S.A.

Daryl Myers, Thomas Stoffel, and Chester Wells
Solar Energy Research Institute
1617 Cole Boulevard
Golden, Colorado 80401
U.S.A.

B.1 DEFINITION AND BACKGROUND

Pyranometers are instruments used to measure global solar radiation [B-1]. The intensity of this radiation combines the components of the incoming direct beam and the diffuse sky solar radiation as received from a 2π sr solid angle above the plane of the instrument's sensing surface. The instrument is generally used to measure radiation over the solar spectrum wavelength range of about 0.3 to 3.0 micrometers.

Webster [B-2] defines this instrument as:

PYRA·NOM·E·TER|, pira'näm d' a(r), pīr-|n [ISV pyr- +ano+
-meter]: an instrument for measuring radiation from the sky
by comparing the heating effect of such radiation upon two
blackened metallic strips with that produced in the same
strips when heated by means of an electric current.

Merriam-Webster Pronunciation Symbols:

i...tip one pronunciation of banish...habit...

ī... site, side, buy...

This description of operation fits only one of several possible designs, in this case the Robitzch bimetallic pyranometer or actinograph [B-3], but does illustrate the concept of equating electrical energy, which can be measured directly, with solar radiation intensity.

The ideal pyranometer would be characterized as having an output signal S which is directly proportional to the sum of the vertical component of direct normal radiation (the beam intensity I multiplied by the cosine of the incidence angle θ or zenith angle for horizontally mounted instruments) and the diffuse sky radiation D :

$$S \propto I \times \cos(\theta) + D \quad . \quad (B-1)$$

Pyranometers available today are simple instruments in fundamental concept, though complex in their true microscopic behavior. They are adequate for most meteorological measurement applications with the use of a single calibration factor C_f , to convert the output signal into units of irradiance, i.e., watts per square meter, for global solar radiation $K\downarrow$:

$$K\downarrow = C_f \times S \quad . \quad (B-2)$$

A more recent application of pyranometry has been for solar collector performance testing. Here, the pyranometer measurements obtained with a single calibration factor are not sufficiently accurate to meet the needs of the solar test engineer in determining the precise amounts of solar energy incident to the collector. In fact, it remains to be proven that sufficient accuracy can be achieved for these purposes using the best of present methods for determining and applying corrections to the measurements.

The following information is placed in this report to aid the reader in understanding pyranometry, specifically those concepts discussed at the conference, and the principles underlying the experimental work embodied in the Statement of Work which was outlined during the meeting.

B.2 GENERAL FEATURES OF A PYRANOMETER

A pyranometer consists of the following basic components:

1. A detector or sensing element protected by glass dome(s), teflon envelopes, or a solid acrylic diffuser,
2. An instrument case (body) with a spirit level, adjustable leveling screws, and a desiccant chamber,
3. Some type of radiation shield which protects the case of the instrument from direct sunlight (a requirement for thermopile designs using the case as the reference junction),
4. An electrical connector or attached cable for the output signal.

The physical design of the detecting surface or sensing element can be based upon the principles of either a thermocouple or photoelectric effect. This results in the commercial availability of multijunction thermocouples (thermopile) and silicon cell or photodiode pyranometers (see Fig. B-1).

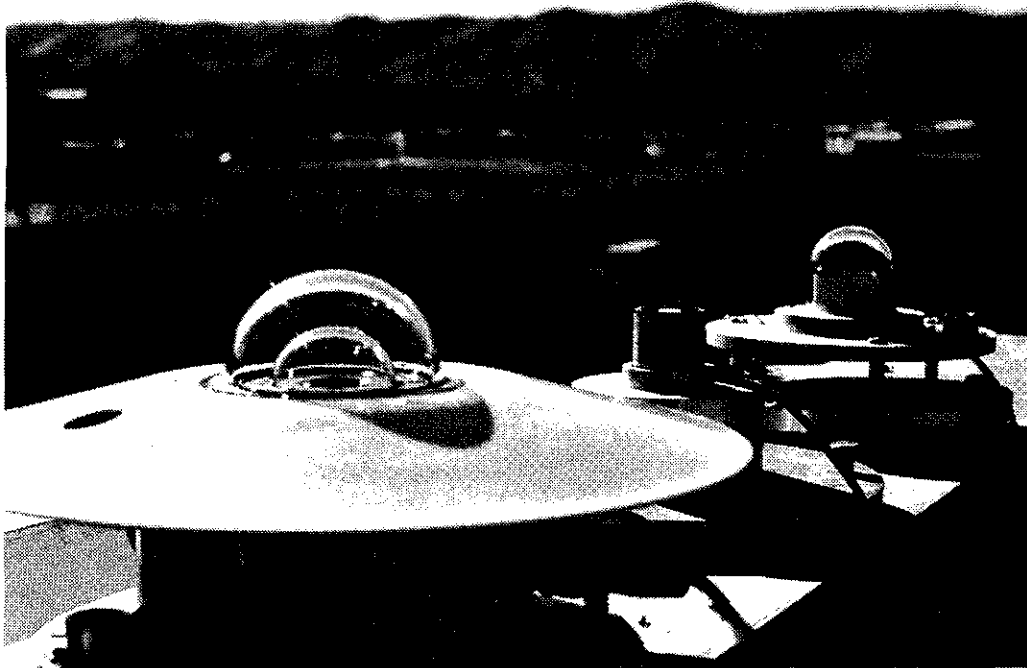

Figure B-1. Examples of Thermopile (Eppley PSP), Photodiode (Li-Cor LI-200S), and Silicon Cell (Matrix MK-1G) Pyranometer (Photo by Tom Stoffel)

A thermopile type pyranometer is typically 15 to 30 cm in diameter overall, is about 15 cm high, and weighs 0.5 to 3 kg. The sensitive area is, in general, less than 6 cm in diameter with some surface coating or treatment (e.g., Parsons Optical Black lacquer or 3M Black Velvet paint). The shape of the sensor surface varies, as does the shape of the thermopile. The Eppley Precision Spectral Pyranometer (PSP), for example, utilizes a wire-wound rectangular thermopile under a circular film covering which is painted black. The spirit level used to set the sensor surface (actually the attachment point on the case) to a horizontal plane usually has an accuracy better than $\pm 0.3^\circ$ (see Sec. B.3.8).

The silicon-based pyranometer is typically 1 to 10 cm in diameter, stands 2 to 10 cm high, and weighs 0.1 to 0.5 kg. The detecting surface is generally less than 1.0 cm in diameter for photodiodes and 2.5 cm on a side for exposed solar cells.

B.3 PYRANOMETER CHARACTERISTICS

B.3.1 Instrument Sensitivity

In the case of an ideal pyranometer, mounted in a horizontal plane, the output signal is proportional to the vertical component of the direct normal radiation (i.e., direct beam radiation as measured with a pyr heliometer multiplied by the cosine of the zenith angle) plus the diffuse sky radiation, without interference by any other parameters (see Equation B-1).

In practice, however, all pyranometers show deviations from the ideal due to the manner in which complicating influences affect the measurement and are accounted for in the final analysis. A pyranometer's "sensitivity" is defined as the ratio of the output signal to the received irradiance. It can be a function of several factors, including the magnitude and direction of the irradiance vector(s), position of the sensor, environmental conditions, time, etc. The text which follows describes those factors that influence pyranometer measurements. The order of their appearance coincides with the suggested characterization procedure, which avoids compounding effects.

B.3.2 Response with Time

The time response of an instrument can be defined in terms of its response to a step input. The "response time" of a pyranometer is the time for the output signal to fall (rise) to 10% (90%) of the final steady-state value change following an abrupt decrease (increase) in irradiance. The so-called "rise" and "fall" times for the instrument are often not equal. The "time constant" is defined as the time in seconds for the transient signal to decay (rise) to $1/e$ ($1-1/e$) of the total change.

B.3.3 Sensitivity

Sensitivity R is simply the ratio of the output signal of the pyranometer S to received irradiance E_g :

$$R = S/E_g \quad . \quad (B-3)$$

In general, a single sensitivity number represents the mean value derived from a range of test conditions, i.e., from integrated output signals over varying time scales--typically ranging from minutes to weeks. A single number may also represent a value generated under a specified set of test conditions. The single sensitivity number is often referred to as the calibration factor C_f .

The conditions under which the pyranometer sensitivity was measured must be reported to the user in order to correctly apply the value to the measured output signal and convert it into units of irradiation. This concept forms the basis of the sensitivity function hypothesis, which proposes that the sensitivity of a pyranometer is a variable quantity, depending upon the individual or combined effects of the aforementioned outside influences (see Sec. B.4).

B.3.4 Responsivity

Responsivity, a term closely related to sensitivity, is usually defined as the ratio of the output signal S to the radiant power P_i incident upon the detector:

$$\text{Responsivity} = S/P_i \quad , \quad (B-4)$$

typically expressed in terms of volts/watt. For pyranometry, the radiant power per unit area, or irradiance (watts/square meter), is desired. Responsivity is a widely used term in the field of radiometry and photometry [B-4,5,6].

B.3.5 Temperature Coefficient of Sensitivity

Radiometers exhibit a change of sensitivity with variations of instrument temperature. This temperature dependence is usually specified as the ratio

$$C_T = \frac{\Delta R/R}{\Delta T} \quad , \quad (B-5)$$

where

C_T = temperature coefficient,

$\Delta R/R$ = relative change in sensitivity,

ΔT = change in case temperature.

C_T is often given by the manufacturer in %/K. Some pyranometers have been designed with resistive networks which compensate for nearly all of the instrument's temperature dependence. Some models, especially earlier designs, have been tested by the manufacturers, who then provide a value for C_T , usually in terms of percentage change in sensitivity per degree of temperature departure from a reference or calibration value.

Figure B-2 shows data from three different tests for both compensated and uncompensated instruments. Table B-1 summarizes the manufacturers' specifications for this and other characteristics.

B.3.6 Thermal Transient Response

The time rate of change in the temperature coefficient is a function of the magnitude and nature of the forcing function (the temperature differences and their time rate of change), and of the instrument's physical properties.

B.3.7 Linearity

The ideal pyranometer should provide an output signal that is directly proportional to the radiation received over a normal range of irradiance levels. As shown in Table B-1, most instruments have a sensitivity which varies within $\pm 2\%$ up to an irradiance of one solar constant (1377 W/m^2 [B-13]).

B.3.8 Angular Dependence of Sensitivity

Global radiation, as measured by a pyranometer, requires an integration of diffuse radiance over the entire hemisphere above the plane of the sensor. This angular integration imposes stringent requirements on both materials and basic design of the instrument if its sensitivity is to be independent of the angle of incidence of the radiation [B-3]. Three angular dependence errors are common to pyranometer measurements:

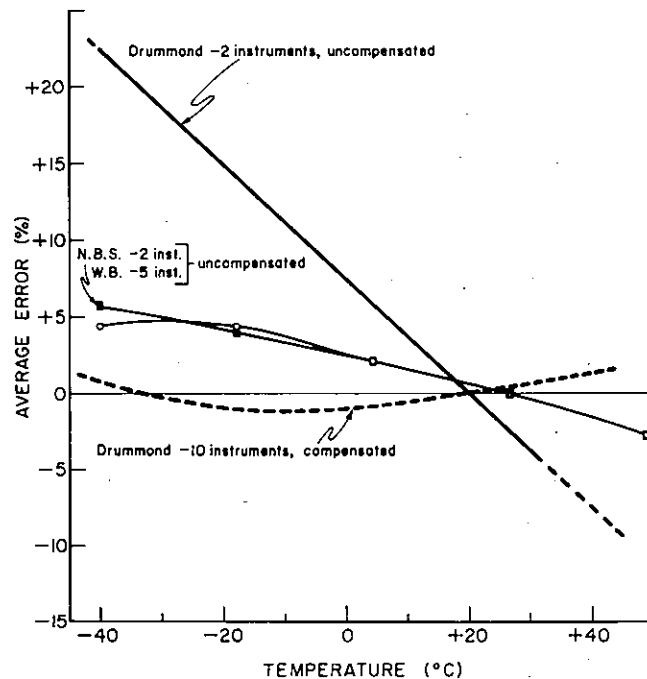

© 1975, Academic Press, Inc.

Figure B-2. Average Error as a Function of Temperature for Eppley Pyranometers Which Are Compensated and Uncompensated for Temperature Effects (From Ref. B-3)

Table B-1. Manufacturer Specifications for a Sample of Pyranometers

Manufacturer	Model	Detector Type	Temperature Dependence	Linearity	Cosine Response	Time Constant--Response Time	Effects of Tilt
Eppley Laboratory	PSP	Thermopile	±1% (-20° to 40°C)	±0.5% (0-2800 W/m ²)	±1% 0°-70° ±3% 70°-80°	1 s (1/e) of signal	Unaffected
Kipp & Zonen	CM5	Thermopile	0.15% per °C	1%	-----	70% of final value in 3 s 99% of final value in 30 s	-----
Kipp & Zonen	CM11	Thermopile	±1% (-10° to 40°C)	±0.5% (0-1400 W/m ²)	<3% at 80°	<5 s (1/e) 98% in 24 s	0.5% for 0°-70° (at 1400 W/m ²)
Phillipp Schenk	Star 8101	Thermopile	+3% per °C	1% (80-1300 W/m ²)	1% 0°-60° ±% 60°-80°	95% of final value in 20 s	±1% for 0°-180°
Lintronic Ltd	Dome 615	Thermopile	-0.2% per °C	-----	±2% 0°-65° ±4% 65°-80°	66% of final value in 20 s 99% of final value in 30 min	-----
Hollis Observatory	MR-5	Silicon Diode	±1.5% (-20° to 40°C)	±1% (0-1400 W/m ²)	±1.5% 0°-80°	-----	-----
LiCor, Inc.	LI-200B	Silicon Diode	±0.15% per °C (maximum)	1% max (0-3000 W/m ²)	corrected 0°-80°	10-90% in 10 microsec	-----
Matrix, Inc.	MK-1G	Silicon Cell	compensated 4.5° to 60°C	-----	-----	100% in less than 1 millisecc	-----

- Cosine error is the result of directional dependence of the pyranometer sensitivity to solar elevation (for horizontally mounted instruments) or, more generally, the incidence angle defined by the radiation vector and the unit vector normal to the sensing surface. Ideally, the vertical component of the radiation is accepted by the detector according to the Lambert cosine law. In fact, the reflectance/absorptance of any surface is dependent on the angle at which the radiation strikes the surface. Additionally, striations or optical defects in the glass hemispherical envelope(s), curvature of the receiver surface, or internal reflections inside the pyranometer may contribute to this error. By calibrating instrument sensitivity versus angle of incidence of the (direct beam) radiation, it is possible to correct the data in some cases (see Fig. B-3).
- Azimuthal error is the result of directional dependence of the pyranometer sensitivity to solar azimuth or the azimuthal orientation of the detector with respect to the radiation vector. This error is due to the surface irregularities, misleveling, or asymmetrical design of the sensing element. Common practice is to position the pyranometer signal cable to the north or other reference direction to reduce the possible discrepancies between the instruments under test.
- Tilt effects are known to exist in some pyranometers. The sensitivity of the instrument can change depending on the orientation of the detector with respect to the horizontal. Figure B-4 illustrates this effect as determined by two laboratories [B-7]. Convective air currents above the sensing surface of the dome-design pyranometers contribute to this error which is a function of tilt angle and irradiance level. Obviously, measurements of global radiation on inclined surfaces would have errors introduced due to a combination of tilt effects and cosine errors associated with the changing incidence angles of the radiation. Different results are reported by various authors.

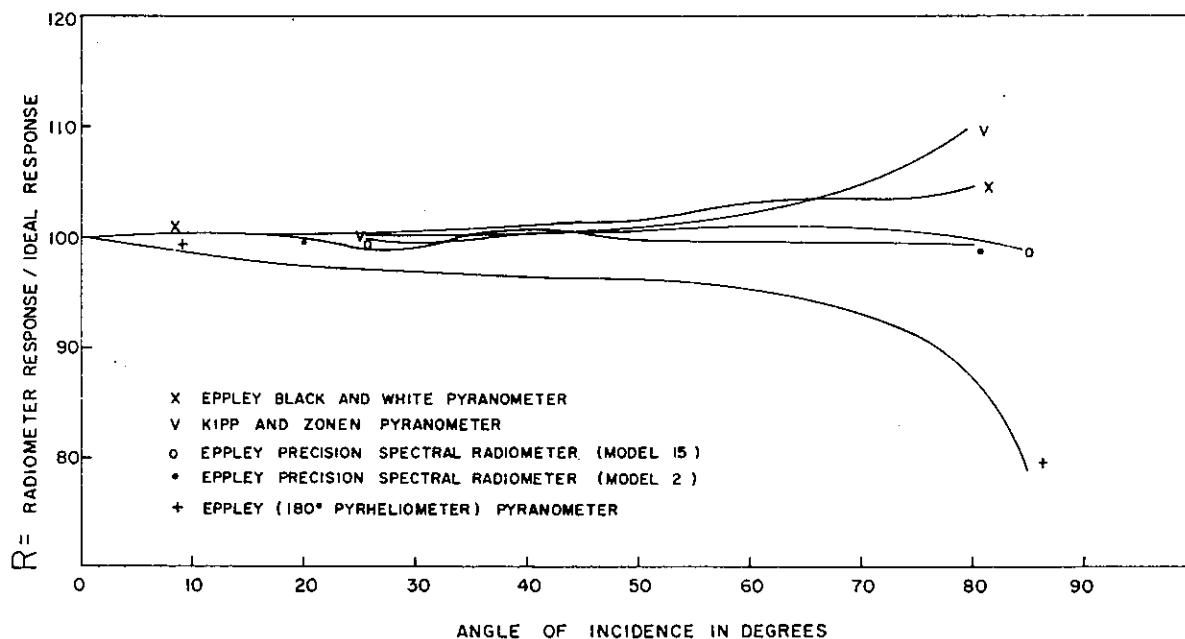

© 1972, Information Canada

Figure B-3. Typical Cosine Response of a Number of Radiometers
(From Ref. B-7)

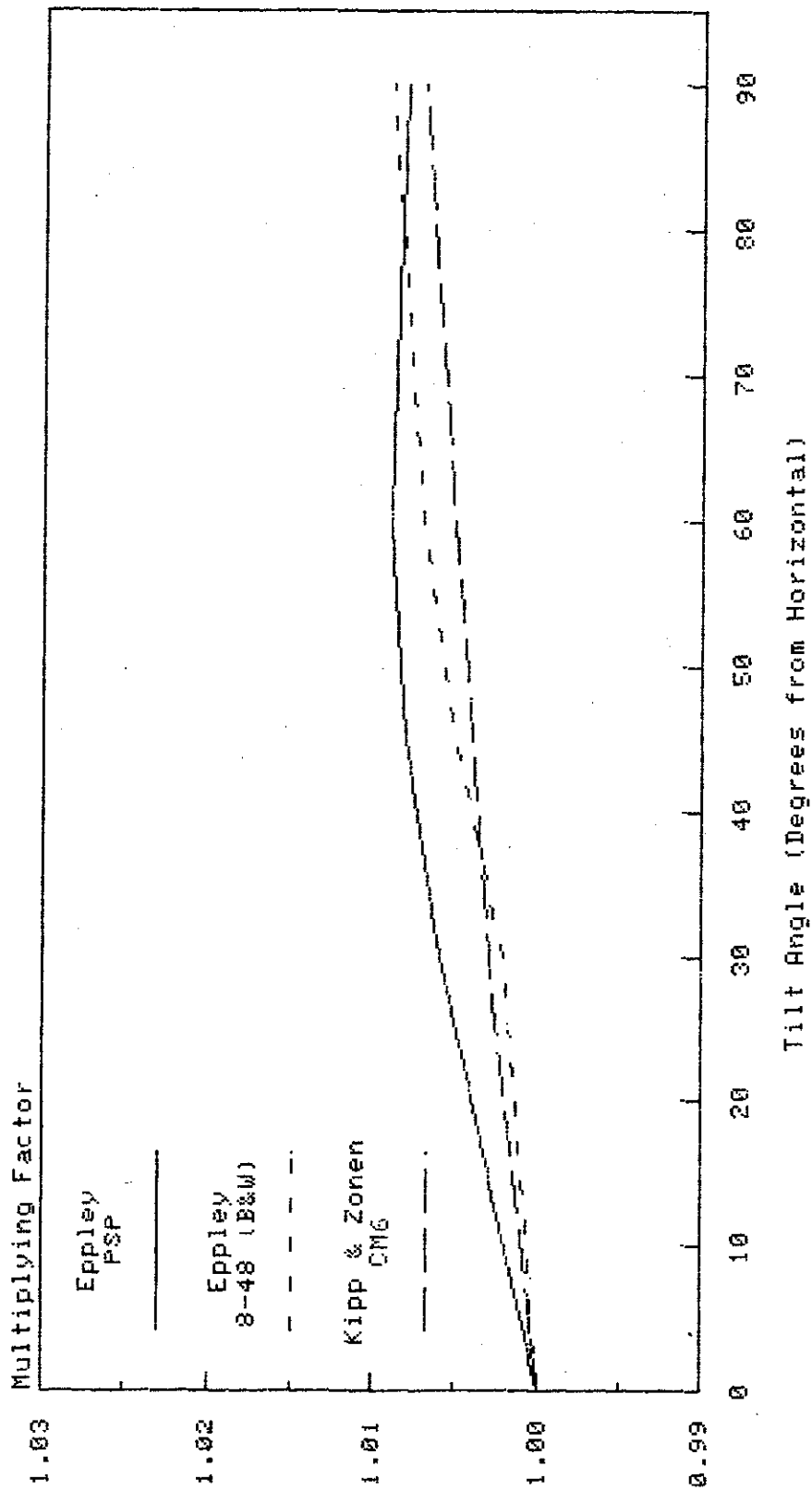

Testing Done by Latimer (1970).

Figure B-4a. Examples of Test Results Evaluating the Tilt Effects on Three Models of Pyranometers [from Ref. B-7, page 25]

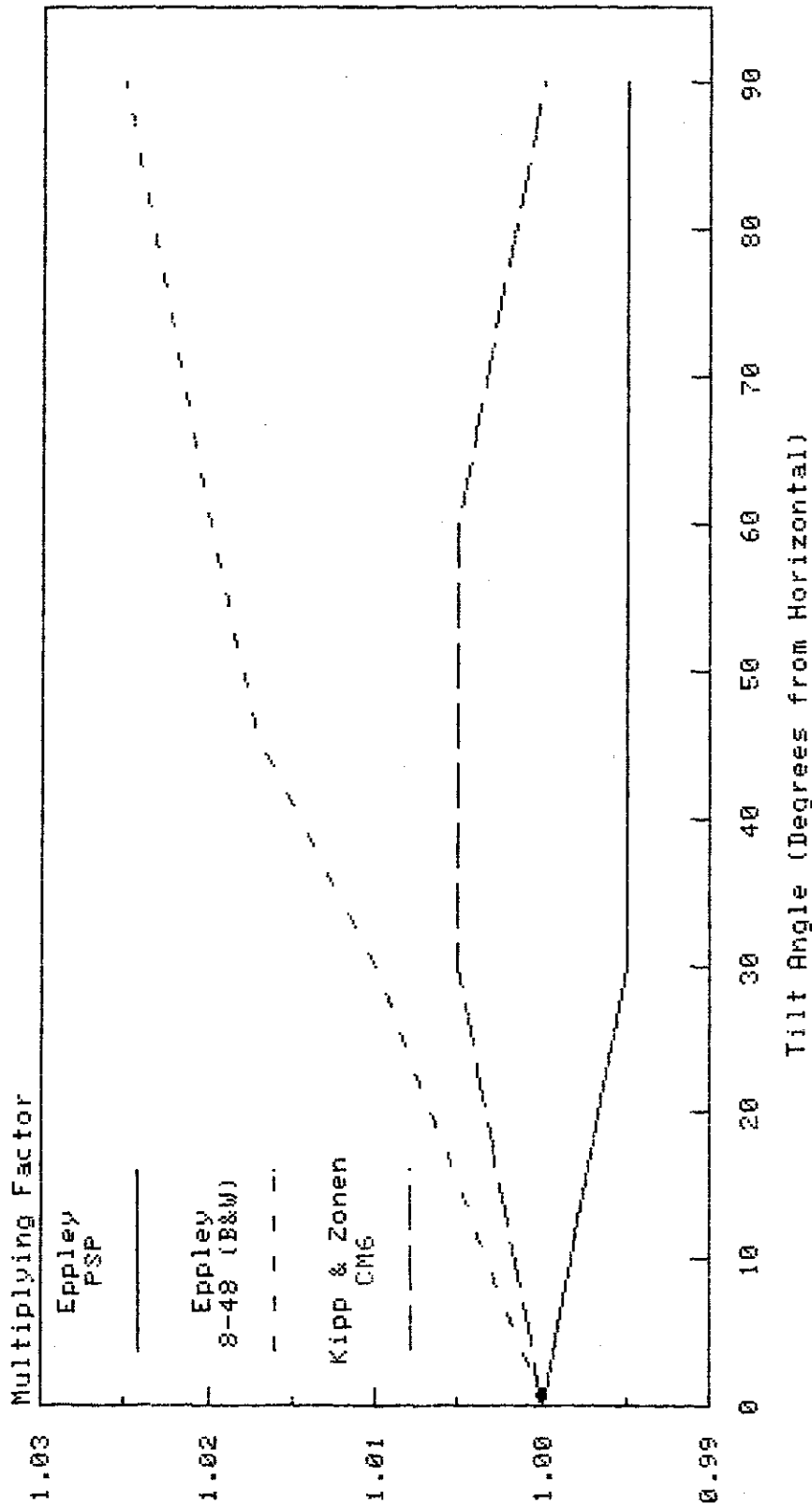

Testing Done by Flowers (1977).

Figure B-4b. Examples of Test Results Evaluating the Tilt Effects on Three Models of Pyranometers [from Ref. B-7, page 25]

B.3.8 Leveling

The detector surface and the reference surface of the spirit level are generally assumed to be coplanar. Production tolerances must allow for some departure from this ideal condition. The accuracy of a typical spirit level commercially available instruments is generally better than $\pm 0.3\%$. The level can be adjusted to coincide with the true optical level of the detector by illuminating the pyranometer at some angle from the normal to the sensing element, usually 70° to 80° , rotating the instrument in azimuth, and adjusting the attitude until the output signal is constant with azimuthal position with respect to the light source. Azimuthal dependencies of the sensitivity must also be accounted for in this test (see Sec. B.3.7).

B.3.9 Spectral Response

The ideal instrument for measuring solar radiation would have a uniform sensitivity or "flat" response to radiation in the wavelength range of about 0.3 to 3.0 micrometers and not detect radiation outside this spectral region (see Fig. B-5). In practice, this is not the case with commercially available pyranometers.

Differences between pyranometers are caused by many factors, including:

- variations in the spectral characteristics of the transmission and reflection coefficients of cover glass dome(s), windows, and radiation shields and differences in the absorption characteristics of sensor surfaces; and
- variations in the electrical nature of the detection mechanism (particularly in photovoltaic detectors).

Photovoltaic detectors have distinct spectral response characteristics resulting from the photoelectric effect displayed by silicon (see Fig. B-5).

A number of conclusions are worth drawing at this point:

- If a pyranometer does not have the desired flat spectral response from 0.3 to 3.0 micrometers, its sensitivity will vary with atmospheric conditions which alter the spectral distribution of the solar radiation.
- Under changing atmospheric conditions, two pyranometers with the same spectral response would produce measurement agreement, even if their response was not flat, but they would not agree with a unit that did have a flat response or a different spectral response.
- Two different models of radiation detectors which might agree in sunlight may differ by several percent under artificial light (or vice versa), because of the differences between the spectra of the two radiation sources [B-8].

Results of comparisons between thermopile and photodiode pyranometers are presented in Appendix R.

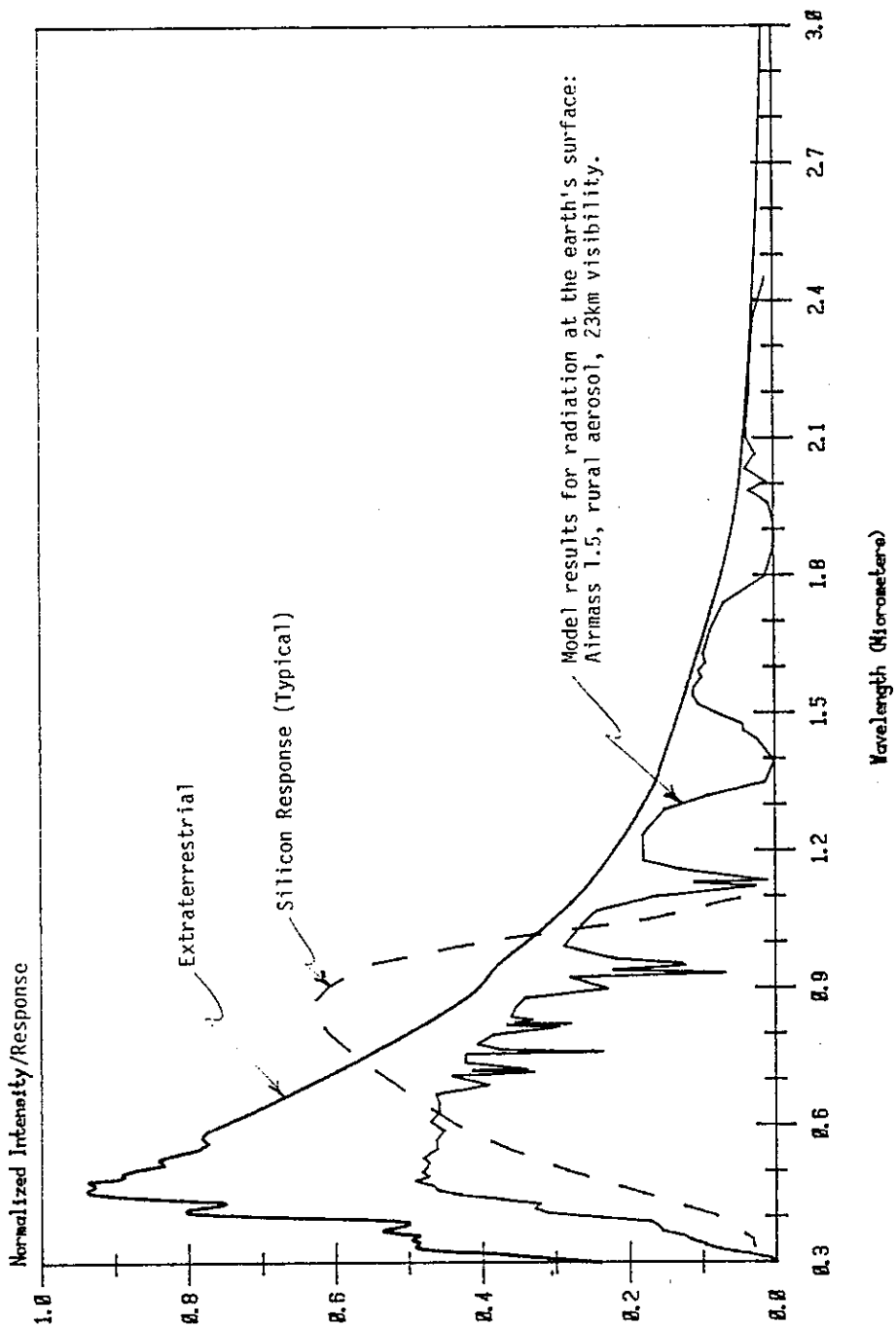

Figure B-5. A Summary of Spectral Distributions of Extraterrestrial Radiation Incident at the Top of the Atmosphere, the Results of the SOLTRAN Computer Model of Transmitted Radiation, and a Typical Silicon Response Curve (After Ref. B-12)

B.3.10 Stability

Pyranometer sensitivity changes with time and with exposure to radiation. Periodic calibrations are suggested by most manufacturers and are required for accurate measurement capability. Pyranometers in continuous use should be calibrated as necessary on the basis of accuracy requirements and drift trends (likely, at least annually).

B.4 PYRANOMETER SENSITIVITY FUNCTION

The "characterizing" of pyranometers is defined as the quantifying of the responses of the instrument to the various parameters mentioned above which produce the "sensitivity function":

$$R = f(E_g, \dot{E}_g, \beta, \theta, a, T, \dot{T}, \Delta T_n, \lambda, P, \dots) \quad , \quad (B-6)$$

where

- R = sensitivity (typically, volts/watt/square meter)
- E_g = global irradiance at receiver (effects of non-linearity)
- \dot{E}_g = time rate of change of global irradiance (effects of time constant)
- β = angle between the normal to the instrument and the horizontal (effects of tilt)
- θ = angle between the incident beam and the receiver normal (effects of cosine error)
- a = angle to the incident beam measured about the receiver normal with respect to a reference direction, typically the center line of the connector (effects of azimuthal dependence)
- T = temperature of the instrument body, usually intended to indicate the thermopile heat sink or cold thermojunction temperature, but often approximated by measuring ambient air temperature surrounding the instrument
- \dot{T} = thermal transients or time rate of change in temperature
- ΔT_n = gradients and temperature differences between parts within the instrument (e.g., glass dome(s) and body, or body and thermopile cold junctions)
- λ = wavelength of incident radiation (effects of spectral response)
- P = pressure (pressure dependence of thermal convection of air).

Note that this analysis of the response of the pyranometer is to be contrasted with the classical view of the instrument calibration in which a single value of sensitivity (calibration factor C_f) is determined by averaging the ratios

of output signals to received irradiances (equation B-3) from a specified test or tests performed in the laboratory or outdoors. Such techniques do not isolate the individual effects described above and limit the application of any detailed characterization information. It has been shown that C_f does vary measurably with respect to some of the above parameters (see Appendices D, F, H, K, M, N, O, and P). For increased accuracy in pyranometry, it is apparent that the documentation (characterization) of the effects of the variables in the sensitivity function is necessary. When these factors are measured, we can construct a transfer function,

$$\hat{f} = \prod_i f_i \quad , \quad (B-7)$$

or

$$\hat{g} = \sum_k g_k \quad , \quad (B-8)$$

which applies these effects as corrections to a basic sensitivity R_0 , thus yielding more accurate pyranometer measurements.

If a single sensitivity R_0 can be defined based on proper testing procedure which quantifies the individual characteristics of a pyranometer, then

$$R = R_0 \times \hat{f}(E_g, \dot{E}_g, \beta, \theta, a, T, \dot{T}, \Delta T_n, \lambda, P \dots) \quad . \quad (B-9)$$

It may not be possible to separate the effects of some individual variables. This means that it is not possible in every case to produce a set of independent functions which can be combined to form equations B-7 or B-8. More explicitly, with

$$S/R_0 = E_0 \quad , \quad (B-10)$$

where

S = instrument output signal

R_0 = basic sensitivity

E_0 = first estimate of global irradiance,

the applications of the transfer function may result in the computation of the corrected irradiance value E_{corr} according to some function of the form

$$E_{corr} = E_0 \times f_1(E_0, T) \times f_2(E_0, \beta) \times f_3(E_0, \theta) \dots \quad , \quad (B-11)$$

or

$$E_{corr} = E_0 + g_1(E_0, T) + g_2(E_0, \beta) + g_3(E_0, \theta) \dots \quad , \quad (B-12)$$

or combinations of products and sums of correction functions. The structure of the transfer function will depend upon the order, manner, and form in which the correction functions are derived.

Generalized discussions of the mathematical and engineering implications of the transfer function concept, sensitivity (responsivity), linearity analysis (including nonlinear systems), detector calibration, and sources of uncertainty are covered in detail by Wyatt [B4]. Additional insight into this topic may also be gained from discussions in Wolfe and Zissis [B5] and the National Bureau of Standards tutorials on optical radiation [B6], especially Chapter 5.

In the final applications of this transfer function to solar collector tests, more detailed measurements of environmental and other parameters influencing the output of the pyranometer will be required to achieve enhanced accuracy over the more common applications of this instrument in meteorology.

An overview of current laboratory testing practices is given in Appendix Q.

B.5 REFERENCES

- B-1. Hay, John E. 1980. "Terminology, Symbols and Units for Solar Radiation Studies." Proceedings, First Canadian Solar Radiation Data Workshop. Toronto, Ontario: 17-19 April 1978.
- B-2. Gove, Philip Babcock, editor. 1976. Webster's Third New International Dictionary of the English Language, Unabridged. Springfield, MA: G. & C. Merriam Co.
- B-3. Coulson, Kinsell L. 1975. Solar and Terrestrial Radiation, Methods and Measurements. New York: Academic Press.
- B-4. Wyatt, Clair L. 1978. Radiometric Calibration: Theory and Methods. New York: Academic Press.
- B-5. Wolfe, William L.; Zissis, George J. 1978. The Infrared Handbook. Washington, D.C.: Office of Naval Research, Department of the Navy.
- B-6. Nicodemus, Fred E., editor. 1976. Self-Study Manual on Optical Radiation Measurements. NBS Technical Notes 910-1,2,3. Washington, D.C.: National Bureau of Standards. Available from the U.S. Government Printing Office.
- B-7. Latimer, J. R. 1980. "Canadian Procedures for Monitoring Solar Radiation." Proceedings, First Canadian Solar Radiation Data Workshop. Toronto, Ontario: 17-19 April 1978.
- B-8. Bahm, Raymond J.; Nakos, John C. 1979. The Calibration of Solar Radiation Measuring Instruments. Albuquerque, NM: Bureau of Engineering Research, University of New Mexico.
- B-9. Latimer, J. R. 1970. "Investigation of Solar Radiation Instruments at the National Radiation Centre of the Canadian Meteorological Service." Paper No. 3/1. International Solar Energy Conference, Melbourne: March 1970.
- B-10. Latimer, J. R. 1971. Radiation Measurement. International Field Year for the Great Lakes, Technical Manual Series No. 2. Ottawa, Ontario: Canadian National Committee for the International Hydrological Decade.

- B-11. Flowers, E. 1977. Test and Evaluation of the Performance of Solar Radiation Sensors at Inclination from the Horizontal Under Laboratory and Field Conditions. Report ERDA-NOAA IAA E(49-26)-1041, T003. Boulder, CO: Environmental Research Laboratories, National Oceanic and Atmospheric Administration.
- B-12. Bird, Richard E.; Hulstrom, Roland L. 1981 (Jan.). Solar Spectral Measurements and Modeling. Golden, CO: Solar Energy Research Institute.
- B-13. NOAA (National Oceanic and Atmospheric Administration). 1977 (Dec.). SOLMET Volume 1: User's Manual, TD9724, Hourly Solar Radiation-Surface Meteorological Observations. Natinal Climatic Center, Asheville, NC 28801.

APPENDIX C

**Status of the Ad Hoc Round-Robin Tests Subsequent to the
IEA Davos Pyranometer Comparisons of March 1980**

by

Edwin Flowers
National Oceanic and Atmospheric Administration
Solar Radiation Facility R32x2
325 Broadway
Boulder, Colorado 80303
U.S.A.

Claus Fröhlich
Physico-Meteorological Observatory
Post Office Box 173
CH-7260
Davos Dorf
Switzerland

John Hickey
The Eppley Laboratory, Inc.
12 Sheffield Avenue
Newport, Rhode Island 02840
U.S.A.

Thomas Stoffel
Solar Energy Research Institute
1617 Cole Boulevard
Golden, Colorado 80401
U.S.A.

David Wardle
National Atmospheric Radiation Centre
Atmospheric Environment Service
4905 Dufferin Street
Downsview, Ontario M3H 5T4
Canada

**STATUS OF THE AD HOC ROUND ROBIN TESTS SUBSEQUENT TO THE IEA DAVOS
PYRANOMETER COMPARISONS OF MARCH 1980**

by
**E. Flowers, C. Fröhlich, J. Hickey, T. Stoffel,
and D. Wardle**

C.1 INTRODUCTION

The World Radiation Center, Physico-Meteorological Observatory, Davos (WRC/PMOD) was asked by members of the IEA Solar Heating and Cooling Program, Task III to evaluate the performance of production-class pyranometers under outdoor conditions. One conclusion from the analysis of this March 1980 data was that differences in irradiance measurements from the various pyranometers (Eppley, Kipp & Zonen, Schenk, and the PMOD reference) were typically 7%, well above a level acceptable to members of the IEA Task III. These differences were interpreted to be the result of calibration uncertainties and unidentified differences in instrument characteristics.

At the recommendation of DSET Labs (New River, Arizona, U.S.A.) and the Kernforschungsanlage (KFA, Germany), three instruments were circulated among three laboratories (SRF, DSET, Eppley) in the United States. This first Round Robin experiment (RRI) was designed to reveal the differences experienced at Davos.

Following the suggestions made during the October 1980 Task V meeting in Toronto, Canada, 22 instruments are in the process of more extensive investigations as part of Round Robin II (RRII). In order of participation, the instruments are being tested by the Atmospheric Environment Service's National Atmospheric Radiation Center (AES/NARC), the National Oceanic and Atmospheric Administration's Solar Radiation Facility (NOAA/SRF), and the U.S. Department of Energy's Solar Energy Research Institute (DOE/SERI).

The purpose of RRII is to investigate the differences in calibration constants supplied by different laboratories. Specifically, if we use our knowledge of the corrections for temperature effects on sensitivity and the departure from ideal cosine response to normalize the above results (say, to the conditions defined in the Canadian method), the question to be answered becomes, "How large are the remaining discrepancies?"

C.2 RESULTS

The results of the Davos comparisons, Round Robin I and part of Round Robin II (available to date) are summarized in Table C-1. The reference to the NARC values is made because the technique has been unchanged for ten years, shows long-term stability, and has been employed for large numbers of Eppley and Kipp & Zonen instruments. However, the claim for accuracy is considered to be 3% or less (Appendix L). The details of these original investigations are available in Appendices D through M.

Table C-1. Round Robin Comparisons

ROUND ROBIN I I		ROUND ROBIN I									
SENSITIVITY		RATIOS TO NARC									
$\mu\text{W}^{-1}\text{m}^{-2}$		K/NARC K									
SERIAL #	STICKER	MODIFIED STICKER (to WRR)	NARC K	MODIFIED STICKER	ORIGINAL PMOD	PREFERRED PMOD = orig x1.026	SRF2 1981 (1)	SRF1 1980	DSET "BEST"	EPPLEY 25 Deg. Solar (Elevation)	EPPLEY "Hemisphere Rec"
P S P											
14896	10.02	9.81	9.66	1.016	0.973	0.998	1.026	1.025	1.019	0.962	1.042
15834	8.99	8.88	8.74	1.016	0.966	0.991	1.026				
16692	9.88	9.76	9.55	1.022	0.967	0.992	1.017				
17750	9.26	9.15	9.24	0.990	0.981	1.007	1.034				
17823	8.97	8.86	8.67	1.022	0.977	1.002	1.037				
18978	11.30	11.01	10.61	1.038	0.978	1.004		1.026	1.014	0.997	1.031
19129	10.76	10.37	10.32	1.005	0.988	1.014					
18376	9.39	9.15			*8.78	9.01					
19222	10.17	9.91			*9.32	9.56					
C M 6			MEAN	1.016	0.976	1.001	1.028	1.025	1.017	0.980	1.037
			STD. DEV.	0.015	0.008	0.008	0.008				
75 2438	11.3	11.06	10.45	1.058	0.999	1.025	1.049				
76 3000	11.9	11.64	11.34	1.026	0.982	1.008					
77 3656	12.2	11.94	11.48	1.040	0.999	1.025					
77 3992	12.9	12.62	11.97	1.054	1.009	1.035					
77 4120	13.7	13.41	12.56	1.068	0.999	1.025	1.061	1.025	1.022		1.042
78 4750	11.7	11.45	10.81	1.059	0.976	1.001	1.039				
78 5047	12.5	12.23	11.68	1.047	0.984	1.010					
80 7177	10.9	10.67	10.13	1.053			1.035				
			MEAN	1.051	0.993	1.018	1.046	1.025	1.022		1.042
			STD. DEV.	0.013	0.012	0.012	0.012				
KIPP VALUE REDUCED TO 25°C			MEAN	1.051	0.969	0.993	1.024	1.024	1.021		1.042
			STD. DEV.	0.013			0.010				
C M 10											
79 0059	5.8	5.68	5.65	1.005	0.982	1.008					
80 0077	5.99	5.99	5.83	1.027							
SCHENK											
1626	14.32	14.32	14.51	0.987	0.972	0.997					
			MEAN	1.030	0.973	0.998	1.026				
			STD. DEV.	0.024	0.010	0.010	0.007				

(1) See Appendix G, Part IV for revised analyses.

*Not ratio = real calibration

Since the original analysis of the March 1980 Davis comparisons, a more preferred calibration factor for the Davos reference instrument has been determined (Appendix E). The appropriate values can be found in columns labeled "Original PMOD" and "Pref PMOD" in Table C-1 which show the ratios of the WRC/PMOD calibrations to those at AES/NARC.

The results of RRI testing were summarized in Appendix F by Zerlaut and are presented in Table C-1 as "DSET Best," "Eppley 25," "Eppley Hemi," and "SRF1."

Available results for RRII are shown in columns "NARC K" (calibration factors by NARC), "Ratios to the NARC values for," (1) "Modified Sticker" values, and (2) "SRF2" in Table C-1. As the result of the recalibration of the Eppley Laboratory's sphere calibration (Dome) reference pyranometer 13055F3, the original "Sticker" calibration factor assigned by the manufacturer has been updated for select instruments. A summary of this information is presented in Table C-2.

The temperatures during the various calibrations were as follows:

Laboratory	Calibration Temperature
NARC	25°C
PMOD	-5°C to +10°C (Mean of about +5°C)
SRF1	24°C
SRF2a	5°C
SRF2b	11°C

We will disregard the small-temperature effect of the PSP and we will use -0.125%/°C as a typical temperature coefficient for the Kipp instruments. The results of this reduction are shown in Table C-1.

The solar elevation angles relevant to the calibrations are different for the reference pyranometer maintained by each laboratory:

Laboratory	Reference Pyranometer Normalized To:	Measurements Performed At:
PMOD	50°	15° to 37°
SRF	68°	0° to 56°
NARC	50°	all sphere
Eppley	45°	all hemisphere

C.3 DISCUSSION OF THE RESULTS

A notable result from the information found in Table C-1 is the close agreement between "PMOD Preferred" (original PMOD calibration increased by 2.6%) and "NARC K." This appears to be somewhat fortuitous considering the different calibration methods used by the two laboratories, i.e., indoor and

Table C-2. Table Relating Hemisphere Calibrations at Eppley of IEA Pyranometers: 45° Solar Elevation and 25°C.

Serial No.	Original Sticker Value	Recalibration Value*	Most Probable WRR Value**
14806	10.02	10.07	9.81
15834	8.99	N/A	8.88
16692	9.88	N/A	9.76
17750	9.26	N/A	9.15
17823	8.97	N/A	8.86
18376	9.39	N/A	9.15
18978	11.30	N/A	11.01
19129	10.76	10.64	10.37
19222	10.17	N/A	9.91

* Only two instruments from IEA Round Robin #1.

** Based on recalibration of Dome Reference 13055F3 estimated at 9.2 V/Wm^{-2} at 25°C.

outdoor. The SRF values are slightly higher (2.6%) than NARC and PMOD. The difference between NARC and SRF is explainable, in part, by normalizing to different solar elevations for the reference instruments. (See Appendix L for NARC and Appendix H for SRF.) This accounts for 1.2% of the difference.

The mean ratio of sensitivities determined by the manufacturers to the NARC value (refer also to Table C-3) amounts to:

Manufacturer	Ratio of Responsivities (Manufacturer/NARC)
Eppley	1.016
Kipp & Zonen	1.051 (CM-6)
Schenk	0.987 (one sensor)

Some of this discrepancy is due to the difference in methods used by the manufacturers.

The differences between individual instruments of like manufacturer are typically 1% or more. It is clear these are caused by individual instrument characteristics as summarized in Table C-4. A summary of results for three pyranometers which have been available to all four laboratories is presented in Table C-5. Although based on a very limited data collection, the information shows the range of calibration factors in comparison to the original manufacturer's value which is possible from laboratory testing. The user, however, generally is aware of only the single value assigned to his instrument by the supplier. As seen from the table, instrument-to-instrument variations do exist in addition to differences in calibration values according to the laboratory and the technique.

More accurate results can be obtained only with more detailed knowledge of the individual characteristics of each instrument which are then used in the evaluation of the comparisons.

TABLE C-3 Summary and comparison of manufacturer's calibration factors with those determined by NARC early in 1981 and with those inferred from the comparison exercise at PMOD during March 1980.

SERIAL NO	OWNER	MANUFAC TURER'S K	##### #NARC# # K # #####		MANU.K ----- NARC K	MANU.K ----- PMOD K	NARC K ----- PMOD K
			#	#			
14806	NBS	USA	10.32	# 9.66#	1.037	1.066	1.028
15834		SWEDEN	8.99	# 8.74#	1.029	1.065	1.035
16692		DENMARK	9.88	# 9.55#	1.035	1.070	1.034
17750	NRC	CANADA	9.26	# 9.24#	1.002	1.021	1.019
17823	JULICH	F.R.G.	8.97	# 8.67#	1.035	1.060	1.024
18978	DFVLR	F.R.G.	11.30	#10.61#	1.065	1.088	1.022
19129	DSET	USA	10.76	#10.32#	1.043	1.056	1.012
MEANS OF EPPLEY'S S.D.					1.035 .019	1.061 .020	1.024 .008
75-2438	STUTT GART	F.R.G.	11.3	#10.45#	1.081	1.082	1.001
76-3000		SWITZERLAND	11.9	#11.34#	1.049	1.068	1.018
77-3656	MET. OFFICE	U.K.	12.2	#11.48#	1.063	1.064	1.001
77-3992	DFVLR	F.R.G.	12.9	#11.97#	1.078	1.068	0.991
77-4120	JULICH	F.R.G.	13.7	#12.56#	1.091	1.092	1.001
78-4750		BELGIUM	11.7	#10.81#	1.082	1.109	1.025
78-5047		SWITZERLAND	12.5	#11.68#	1.070	1.087	1.016
80-7177	CARDIFF	U.K.	(I)	#10.13#	-	-	-
MEANS OF CM-6'S S.D.					1.073 0.014	1.081 0.016	1.008 0.012
(II)							
CM10 790059	HAMBURG	F.R.G.	5.8	# 5.65#	1.027	1.045	1.018(N)
CM10 800077		NETHERLANDS	5.99*	# 5.83#	1.027	-	- (N)
STAR 1626	VIENNA	AUSTRIA	14.32	#14.51#	0.987	1.016	1.029(N)

OVERALL MEAN							1.017
S.D.							0.013

- (I) Manufacturer's K = 10.9 (17/3/81)
- (II) IPS : Dehne (IPS) = 5.85
- * WRR
- (N) Not tested against acceptable standard

Table C-4. Pyranometer Characterization Parameters

Characteristic	Remarks
1. Sensitivity: Horizontal	The calibration factor determined by integrating sphere, shading disk, or outdoor comparison with a standard instrument. The classical conversion of the horizontally mounted pyranometer voltage output into power density (Volts/Watts/sq meter).
2. Sensitivity: Tilted	Same as above, but for the pyranometer mounted on an inclined surface.
3. Sensitivity: Tracking	Same as above, but for the pyranometer oriented normal to the sun.
4. Temperature Response	The change in pyranometer sensitivity as a function of ambient air temperature.
5. Cosine Response	A measure of the instrument's divergence from ideal Lambertian cosine law.
6. Azimuth Response	The change in pyranometer sensitivity as a function of azimuthal orientation.
7. Spectral Response	A pyranometer should have uniform sensitivity to radiation over the spectral region (0.28 to 3000 nm).
8. Linearity	Uniform sensitivity over a range of intensity.
9. Time Constant	Time rate for change in sensitivity should accurately reflect time rate of change in irradiance levels.
10. Tilt Effects	The orientation of the pyranometer from the horizontal should not affect sensitivity.
11. Stability	The sensitivity should not change with time.

Table C-5. Inter-Laboratory Comparison of Calibration Factor Assignments

Laboratory	Test Instrument		
	K&Z 774120	EP 14608	EP 19129
Method 1: Shading Disk--Reference Pyrheliometer $\pm 0.5\%$			
DSET	--	9.843	10.427
NOAA			
(60°) ^a	12.61	9.84	10.500
(40°)	12.73	9.52	10.455
(20°)	12.965	9.26	10.410
Eppley			
(30°)	12.15	9.16	10.05
(25°)	12.35	9.29	10.29
Method 2: Pyranometer Comparison--Reference Eppley PSP or PMOD			
WRC/PMOD12.87	12.87	9.644	10.46
NOAA	12.82	9.889	10.588
Eppley (Sphere)	13.09	10.07	10.64
Manufacturer	13.70	10.02	10.76
Range (max-min)	0.94	0.91	0.59
Range/Manufacturer	6.9%	9.1%	5.3%
Mean	12.698	9.642	10.436
Std. Deviation	± 0.320	± 0.337	± 0.180

^aSolar elevation angles for shade calibrations.

APPENDIX D

**Results of a Pyranometer Comparison, Task III:
Performance Testing of Solar Collectors,
A Report by the International Energy Agency
Solar Heating and Cooling Program
Davos, March 5 and 6, 1980**

by

Horst Talarek, Editor
Kernforschungsanlage Jülich GmbH
Institut für Kernphysik/Solar Branch
Post Office Box 1913
D-5170 Jülich
Federal Republic of Germany



IEA
SOLAR R&D

INTERNATIONAL ENERGY AGENCY

program
to develop and test
solar heating
and cooling systems

task III
performance testing
of solar collectors

results of a
pyranometer comparison

Davos, March 5 and 6 1980



Weltstrahlungszentrum Centre Mondial de Rayonnement World Radiation Center
Physikalisch-Meteorologisches Observatorium Davos June 1980

P R E F A C E

An Extraordinary Experts Meeting of the Task III group on Radiation Measurements in Solar Energy Application was held in Davos at the World Radiation Center. During the two days meeting a pyranometer comparison was conducted.

This report is to document the results and the evaluation of the comparison. While the conclusions are necessarily preliminary in character, the results definitely describe the present situation in radiation measurement with pyranometers.

It is the hope of the participants and it is well within the spirit of this interdisciplinary meeting that the results serve as a reference and guidance for future actions.

The participants and in particular the Task III group are greatly indebted to Mr. Fröhlich and his colleagues for their support.

This report was edited by
Kernforschungsanlage Jülich GmbH
Institut für Kernphysik/Solar Branch
P.O.Box 1913
D-5170 Jülich, Fed. Rep. of Germany

H.D. Talarek
Operating Agent for the IEA
Program to Develop and Test
Solar Heating and Cooling
Systems, Task III: Performance
Testing of Solar Collectors

Table of Contents

Program of the Meeting

Staff Members of the WRC

Minutes of the Meeting

List of Participants

Results of the Pyranometer Comparison

Contribution of the U.K. Participants

IEA - TASK III EXPERTS MEETING

March 5/6, 1980 at the
World Radiation Center Davos, Switzerland

P R O G R A M

			<u>Duration</u> *)
5/3	09h15	Opening	15'
	09h30	C. Fröhlich: radiometry and collector testing	50'
	10h20	Coffee break	
	10h40	C. Fröhlich: Radiometric standards and the WRR	30'
	11h10	R. W. Brusa: Absolute radiometers, their principle and design	50'
	12h20	Lunch at the Brauerei (optional)	
	13h45	Calibration of radiation instruments, especially pyranometers:	
		C. Fröhlich: General (horizontal, inclined)	20'
ca	14h05	K. Dehne: Kipp and Zonen solarimeter	30'
ca	14h35	O. Motschka: Stern pyranometer	30'
ca	15h05	K. Dehne / G. Zerlaut : Eppley pyranometer	45'
ca	15h50	Coffee break	
	16h10	C. Wehrli: Spectral measurements, instruments and calibration procedures	50'
6/3	09h00	Demonstration of calibration procedures and evaluation of comparisons	
ca	10h15	Coffee break	
	12h15	Lunch at the Brauerei (optional)	
	13h45	Discussion of results and	
ca	16h00	Closing	

*) Presentation and discussion

Davos, 31.1.1980

STAFF MEMBERS OF THE WORLD RADIATION CENTER DAVOS

<i>Claus Fröhlich, Dr</i>	<i>Director, physicist</i>
<i>Robert W. Brusa</i>	<i>Physicist</i>
<i>Ursula Bühler</i>	<i>Secretary</i>
<i>Daniel Gartmann</i>	<i>Electronics-mechanic, apprentice</i>
<i>Adolf Geisseler</i>	<i>Electronics technician</i>
<i>Anton Rohrer</i>	<i>Laboratory assistant</i>
<i>Hansjörg Roth</i>	<i>Electronics engineer</i>
<i>Christoph Wehrli</i>	<i>Physicist</i>
<i>Urs Wyss</i>	<i>Instrument maker</i>

Davos, 4.3.1980

Minutes of the extraordinary Experts Meeting, TASK III

IEA-Program to Develop and Test Solar Heating and Cooling Systems

Time: March 5/6, 1980
Location: Davos/Switzerland
Host: World Radiation Center,
Dr. C. Fröhlich and his staff

Participants:

The meeting was attended by 26 experts from 10 different IEA-countries. Participants had either a background in meteorology or in collector testing (see list of participants). This was in full accordance with the intention of the IEA-Task III group who considered an interdisciplinary meeting as the most promising action.

In support of this idea, participating IEA-countries readily "sent" invited speakers: Klaus Dehne (Germany), Otto Motschka (Austria) and Gene Zerlaut (USA), who additionally presented a paper by Edwin Flowers (USA).

Basic support and some educational talks were given by the staff members of the World Radiation Center.

Opening

Dr. Claus Fröhlich, director of the WRC, welcomed the participants of the meeting. During the preparation of this meeting the idea of having a comparison of participants' pyranometers was brought forward. Due to the kind assistance of the WRC staff it was possible to conduct a comparative testing of pyranometer performance during the two-days meeting. Participants, therefore, had brought along their instruments one day prior to the meeting which made it possible to monitor the performance for a complete day (March 5) and a subsequent half day (March 6).

A total of 21 instruments manufactured by Eppley, Kipp and Zonen and Schenk were compared.

In reviewing the incentives of the meeting, the Operating Agent stressed the difficulties encountered by experimentalists using pyranometers to ascertain the specified accuracy of their instruments.

The scheduled programme was accepted by the participants.

Morning Session

In a first talk on radiometry and collector testing, Mr. Fröhlich pointed out that the pyranometer was originally developed for climatological measurements (horizontal position). Moreover, the radiation seen by a collector is not necessarily identical with the radiation detected by the pyranometers. A rigorous approach therefore would imply alternative radiation standards for collector testing.

The history of the development of radiation instruments was covered in a second talk.

It became clear that the struggle for a radiometric reference with an intermediate historic compromise (IPS, International Pyrheliometer Scale, of 1956) has lasted up to very recent times. According to the WMO regulations the World Radiometric Reference (WRR) will become the official standard by 01.01.1981.

It was, however, hard to define at what time the different manufacturers had referenced their calibration to a particular radiometric standard.

Mr. Byuso's talk illustrated the contribution of the WRC in the development of absolute radiometers. The absolute accuracy of the PMOD instrument is less than 0.2%. This was considered close to the theoretical limit of accuracy for the compensation technique applied at Davos.

Afternoon Session

The invited speakers reported about their experience with pyranometers of a specific manufacturer:

Eppley (PSP): by G. Zerlaut (Ed. Flowers)

Kipp-Zonen (CM 2-5-10): by G. Dehne

Schenk (Star, black and white): by O. Motschka

The authors promised to provide a summary of their talks which are to be distributed with the documentation of the Davos pyranometer comparison. The investigations reported of, illustrated the physical dependencies of the over-all response of the pyranometers. The deviations caused by varying environmental and operational conditions were investigated by specific experiments. The results indicate that the instrument reading is effected up to several per cent by the following items:

- 1) Spectral sensitivity
- 2) deviations from linear intensity response
- 3) varying ambient temperatures (and wind)
- 4) tilt (deviations from horizontal position)
- 5) incident angle (cosine-response)

The calibration constant of an instrument has to be considered as a function of several parameters. It was felt that results from laboratory experiments showed consistent instrument performance while outdoor experiments with a number of competing effects were less consistently interpretable.

It was not clear, however, to what extent the deviations found were peculiar to the individual instruments or to a specific design (brand). The closing discussion gave evidence that there is no established procedure useful for the experimentalist to gain confidence of the accuracy of irradiance measurements.

Morning Session (March 6)

The session was started by a talk by Mr. Wehrli about spectral measurements. The results from the comparative testing of the participants' pyranometers were presented by Mr. Fröhlich:

The instruments readings were recorded from 10.40 a.m. to 15.30 p.m. Data were sampled at a rate of 10 seconds to produce 10 minutes mean values. These mean values were compared with the WRC-reference pyranometer. Mean deviations - extended over the period of measurements - were evaluated as percentage deviation of the nominal calibration constant (see attached data sheet).

The large deviations found were considered as alarming and disappointing by the participants:

The arithmetic mean of the mean ratios for the group of Eppley (PSP) instruments was roughly 6 %.

The arithmetic mean of the mean ratios for the group of Kipp and Zonen instruments was roughly 7 %.

Most of these instruments are used as secondary standards by the participants. This fact clearly underlines the importance of the results.

Discussing the results, the participants pointed out that the manufacturers' calibration procedure might have introduced systematic errors. Additionally, there is reason to suspect a climatic dependency of the calibration constant.

A comprehensive evaluation based on that one-day intercomparisons was not attempted by the participants. Mr. Fröhlich clearly expressed the participants view when he said: "The results are definitely not conclusive but they are definitive."

Afternoon Session

Appropriate steps to be taken to ease and improve the situation for the experimentalist were discussed.

Based on the common view that the accuracy of irradiance measurements with pyranometers is considered to be unsatisfactory, the participants agreed that a scientific project on comparative pyranometer testing should be initiated.

The realisation of such a programme should comprize:

1. Specification of specimens for the test:

Selection of a relevant number of instruments from three different manufacturers:

e.g. 12 pyranometers	Eppley, PSP
12 pyranometers	Kipp and Zonen, CM-10
12 paranometers	Schenk, Star-Black + White

2. Longterm simultaneous performance monitoring.

Possibly at the WRC in Davos.

A testing period of half a year with case study monitoring.

3. A detailed working programme - set up by the Task III participants and the WRC.

This comparative testing is not to be understood as a competition among pyranometers but as a mean to provide conclusive results on their performance which might have an impact on manufacturer's policy (quality control, additional data sheets).

Another possible result of the envisaged project could be an amendment of the pyranometer calibration procedure.

There is good hope that the project will clarify the procedure, the steps and the precautions that have to be taken by the experimentalist to ascertain a required accuracy of the pyranometer used in measurements of solar irradiance!

The WRC staff offered their assistance to document the results from the Davos-Pyranometer-Intercomparison. The Operating Agent will compile and edit the document.

Again, the Operating Agent will explore the situation for funding of the envisaged test programme.

Closure

On behalf of the participants the Operating Agent expressed his thankfulness to the WRC staff for hosting and promoting the meeting.

H. D. Talarck

LIST OF PARTICIPANTS OF THE IEA-TASK III MEETING, DAVOS 5/6.3.1980

Hans. E.G. ANDERSSON National Testing Institute
Box 857
S-50115 Boras Sweden
phone: 033/102000-228
telex: 36252 testing s

Eric ARANOVITCH C.C.R.
Ispra - Italy
phone: 0332/780131

Carlos CALATAYUD Institut de Thermique Appliquée
de l'EPFL
CH-1015 Lausanne
phone: 021/47 .35.19

Luzi CLAVADETSCHER Eidg. Institut für Reaktorforschung
CH-5303 Würenlingen AG
phone: 056/98.17.41

Hans-Josef DAUM Industrieanlagen-Betriebsgesellschaft
Einsteinstrasse 20
D-8012 Ottobrunn
phone: 089/600.826.12
telex: 0524001

Klaus DEHNE Meteorologisches Observatorium
Frahmredder 95
D-2 Hamburg 65
phone: 040/601.7924

Claude DURAND Institut de Thermique Appliquée
de l'EPFL
CH-1015 Lausanne
phone: 021/47.35.23

Bill W.B. GILLETT Solar Energy Unit
University College
Newport Road
Cardiff CR2 ITA UK
phone: 0222/44211, ext 7041
telex: 49635

Stephen HARRISON
 Division of Building Research
 National Research Council of Canada
 Div. of Building Research
Ottawa Ontario K1A 0R6 Canada
 phone: 993 1421

Johannes KELLER
 Eidg. Institut für Reaktorforschung
 CH-5303 Würenlingen AG
 phone: 056/98.17.41

Paul KESSELRING
 Eidg. Institut für Reaktorforschung
 CH-5303 Würenlingen AG
 phone: 056/98.17.41

Wilfried LEY
 DFVLR
 Linder Höhe
 D-5 Köln 90
 phone: 02203-601-2332

James MCGREGOR
 Solar Energy Unit, Dept. of Mechanical
 Engineering and Energy Studies
 University College, Newport Road
Cardiff CF2 1TA UK
 phone: 0222-44211 ext 7022
 telex: 49635

Otto MOTSCHKA
 Zentralanstalt für Meteorologie und
 Geodynamik
 A-1190 Wien
 phone: 222362172/ 231

André PILATTE
 Faculté Polytechnique de Mons
 31, Bd Dolez
 B-7000 Mons
 phone: 065/338191
 telex: 57764

Augustin RAZAFINDRAIBE
 Groupe Energie Solare de l'EPFL
 14, ave de l'Eglise Anglaise
 CH-1006 Lausanne
 phone: 021/47.34.27

Markus REAL
 Eidg. Institut für Reaktorforschung
 CH-5303 Würenlingen AG
 phone: 056/98.17.41

Konrad SCHREITMÜLLER
 DFVLR
 Institut für Technische Physik
 D-7000 Stuttgart 80
 phone: 0711-7832485 / 429
 telex: 07255689

Christian SPOHN
 Institut für Theorie der Elektrotechnik
 Breitscheidstrasse 3
 D-7000 Stuttgart 1
 phone: 0711-2073357

Jochen STEIN
 Kernforschungsanlage
 Solar Energy Branch - IKP
 Postfach 1913
 D-5170 Jülich
 phone: 02461/6067

Jean-Marc SUTER
 Eidg. Institut für Reaktorforschung
 5303 Würenlingen AG
 phone: 056/98.17.41

Svend SVENDSEN
 Thermal Insulation Laboratory
 Technical University of Denmark
 Bldg. 118, Lundtoftevej 100
 DK-2800 Lyngby Denmark
 phone: 02 883511 ext 5355
 telex: 37 529 dthdia

Horst D. TALAREK
 Kernforschungsanlage
 Solar Energy Branch - IKP
 Postfach 1913
 D-5170 Jülich
 phone: 02461/6067

Heinrich WENZEL
 TÜV Bayern e.V.
 Eichstätter Strasse 5
 D-8000 München 21
 phone: 5791-330

Aad WIJSMAN
 Institute of Applied Physics
 P.O.B. 155
Delft Holland
 phone: 015-569300

Gene ZERLAUT
 DSET Laboratories Inc.
 Box 1850
Phoenix Arizona 85029 USA
 phone: 602-465-356
 telex: 910-950-4681 dset phx

During the 1980 meeting of the IEA Task III working group, held at Davos, comparison of pyranometers has been organized. A total of 22 instruments from 9 countries have participated (Table 1).

For the comparison, the instruments were placed horizontally side by side on the wall in front of the Institute and were connected to the computer controlled WRC data acquisition system. As reference, the WRC standard pyranometer PD 6703A was used. Further, the direct solar radiation was measured with the WRC absolute radiometer PMO2. The reported instrument's temperature was measured with a Pt-thermometer, mounted in the case of PD 6703A. The outputs of all instruments were read every 20 seconds, the ratio to the reference calculated and these values integrated over 10 minutes in order to calculate the mean and standard deviation. In the graphical representation, these 10 minutes values are plotted.

The results of the comparison are summarized in Table 2 and for each instrument in the Figures 1 to 6. During the first day, the sky was most of the time clear, during the second day, it was cloudy to overcast.

From the results, the following conclusions can be drawn:

- (1) All calibration factors given by the manufacturers yield readings which are 6-7 % lower than those referred to the World Radiometric Reference (WRR). Only about 2 % can be explained by the difference between IPS and WRR. The remaining 5 % seem to be due either to the method of calibration or to the reference instrument used.

The mean ratios of the Kipp+Zonen and the Eppley instruments are as follows:

$$\frac{K+Z}{WRR} = 0.9308 \pm 0.0214 \text{ (11 instruments)}$$

$$\frac{\text{Eppley}}{WRR} = 0.9390 \pm 0.0183 \text{ (9 instruments)}$$

- (2) The performance of individual Kipp+Zonen instruments as a function of intensity and type of radiation (predominantly direct or diffuse) can vary significantly from one instrument to another. The performance of the Eppley instruments on the other hand are very similar for all instruments. It seems that the control of manufacturing processes are good at Eppley Laboratory and not sufficient at Kipp+Zonen.
- (3) At the low intensity end of the working range (below about 200 Wm^{-2}), there is a difference in the readings for the two days due to different prevailing types of radiation. Again, this difference is varying from instrument to instrument for the Kipp+Zonen. From the results of the Eppley instruments, one could also argue that the WRC standard instrument has some problems at low intensities (e.g. cosine error at high angles of incidence). Further investigations are needed to clarify this question.

As a result of the above conclusions, the following actions are recommended:

- (1) Continue such comparisons over extended periods of time and supplement the outdoor comparisons with laboratory measurements of cosine response, temperature coefficients, linearity tests, etc.
- (2) Urge the manufacturers to review their method of calibration in order to find the reason for the 5 % difference.

Manufacturer	Instrument	Calibration factor used ($\mu\text{V}/\text{mm}^{-2}$)	Origin of calibration	Owner of instrument
EMCO	6703A	24.825	WRC	World Radiation Center Davos, Switzerland
KippZonen	742 276	10.6	K+Z	Inst. Theorie f. Elektrotechnik, Stuttgart, Germany
	752 438	11.3	K+Z	Inst. Theorie f. Elektrotechnik, Stuttgart, Germany
	763 000	11.36	K+Z	Eidg. Institut für Reaktorforschung, Mürrenlingen, CH
	773 656	11.6	K+Z	Meteorological Office United Kingdom, co University Cardiff
	773 992	11.5	K+Z	DFVLR, Köln, Germany
	774 120	13.7	K+Z	Kernforschungsanlage, Jülich, Germany
	784 750	11.7	K+Z	Faculté Polytechnique, Mons, Belgium
	785 017	10.48	K+Z	World Radiation Center, Davos, Switzerland
	785 047	12.5	K+Z	Ecole Polytechnique Fédérale, Lausanne, Switzerland
	785 967	12.1	K+Z	Ecole Polytechnique Fédérale, Lausanne, Switzerland
	NDH 154	5.7	K+Z	Deutscher Wetterdienst, Observatorium Hamburg, Germany
	2508	12.15	WRC	Meteorological Office United Kingdom co University Cardiff
	Eppley	14 086F	10.02	Ep
15 834F		8.99	Ep	Statens Provningsanstalt, Boras, Sweden
16 692F		9.88	Ep	Thermal Insulation Laboratory, Techn. University, Lyngby, DK
17 750F		9.26	Ep	National Research Council, Energy & Services, Ottawa, Canada
17 823F		8.97	Ep	Kernforschungsanlage, Jülich, Germany
18 376F		9.39	Ep	DFVLR, Stuttgart, Germany
18 978F		11.30	Ep	DFVLR, Stuttgart, Germany
19 129F		10.76	Ep	DSET Laboratories Inc., Phoenix, Arizona, USA
19 322F		10.17	Ep	Techn. Beobachtungsverein Bayern, München, Germany
1026			Sub	Zentralanstalt für Meteorologie & Geodynamik, Wien, Austria

Table 1: List of participating instruments

	Instrument	Mean	Standard deviation	Number of measurements
Kipp + Zonen	742 276	0.9764	0.0110	1956
	752 438	0.9238	0.0076	1956
	763 000	0.9365	0.0119	1956
	773 656	0.9400	0.0090	1956
	773 992	0.9362	0.0096	1956
	774 120	0.9159	0.0110	978
	784 750	0.9019	0.0065	1620
	785 017	0.9164	0.0100	1956
	785 047	0.9200	0.0072	978
	795 967	0.9147	0.0060	978
	MOH 154	0.9568	0.0162	1956
2508	1.0042	0.0219	978	
Eppley	14 806F	0.9378	0.0131	1956
	15 834F	0.9390	0.0136	1956
	16 692F	0.9342	0.0114	1620
	17 750F	0.9795	0.0152	1956
	17 823F	0.9435	0.0179	1956
	18 376F	0.9352	0.0099	1956
	18 978F	0.9187	0.0158	1956
	19 129F	0.9468	0.0163	1956
	19 222F	0.9166	0.0120	1956
Schenk	1626	0.9847	0.0207	1956

Table 2: Results of the pyranometer comparison

Mean ratios of the readings of each individual instrument to the WRC standard for intensities higher than 150 Wm^{-2} .

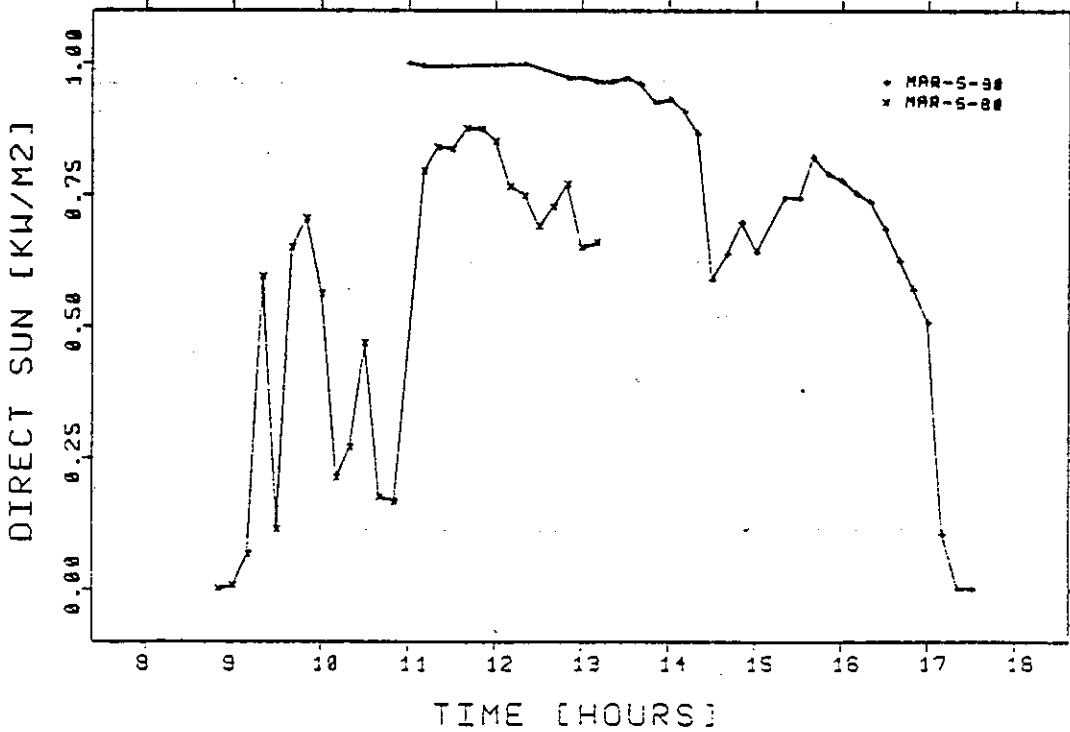
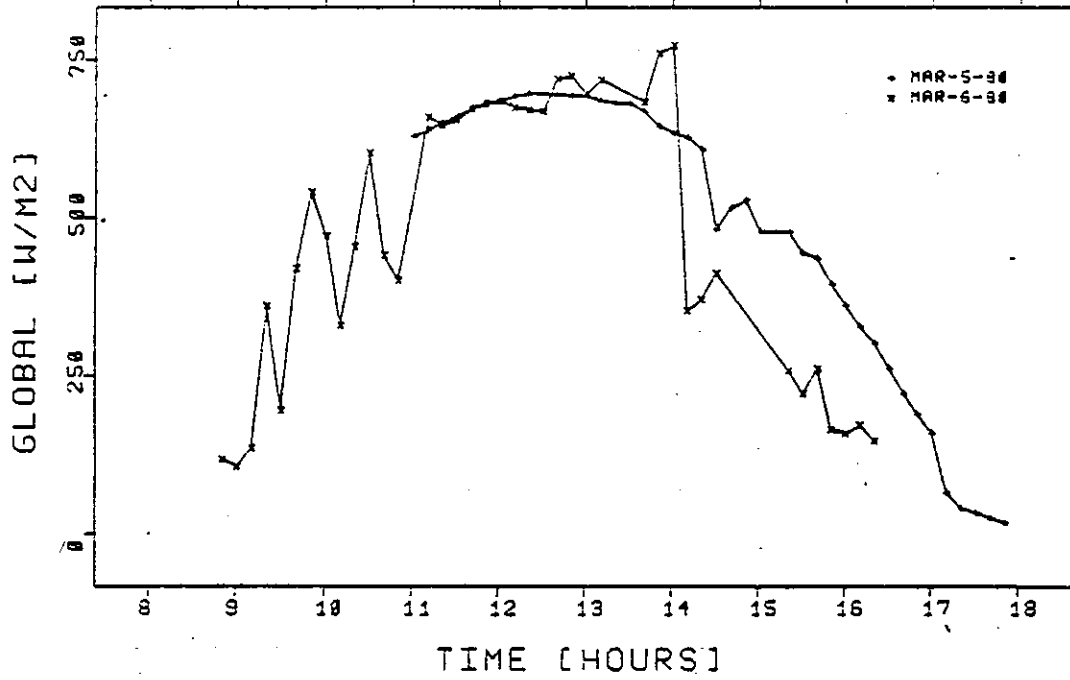

Figures 1a - 1b: Global and direct solar radiation as a function of time of the day for March 5 and 6, 1980.

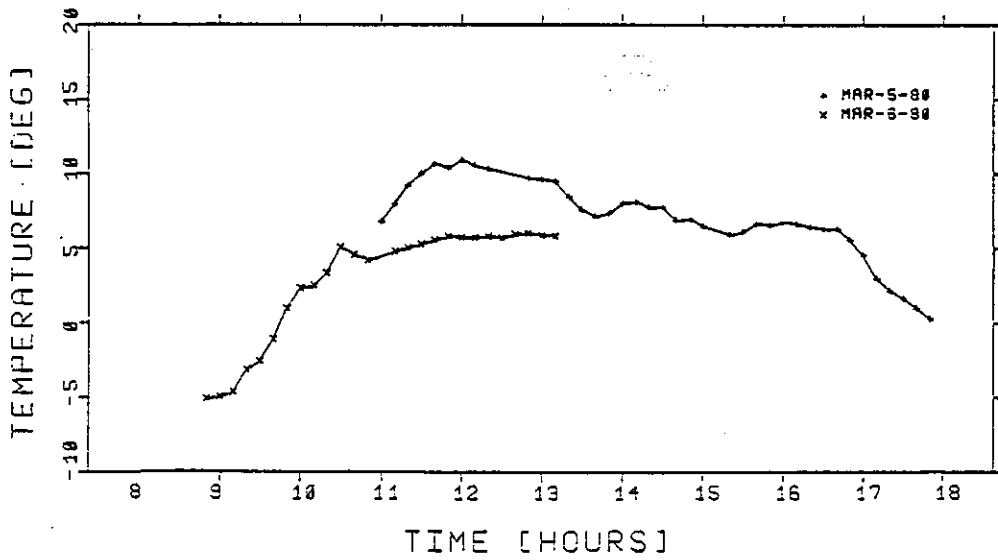
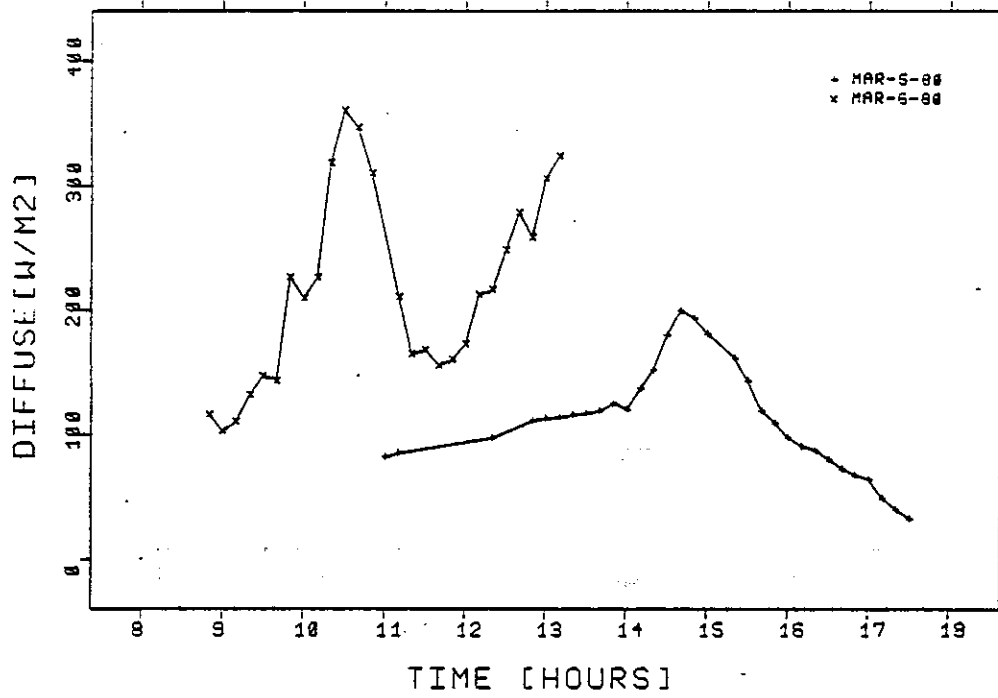

Figures 2a + 2b: Diffuse radiation and instrument temperature as a function of time of the day for March 5 and 6, 1960.

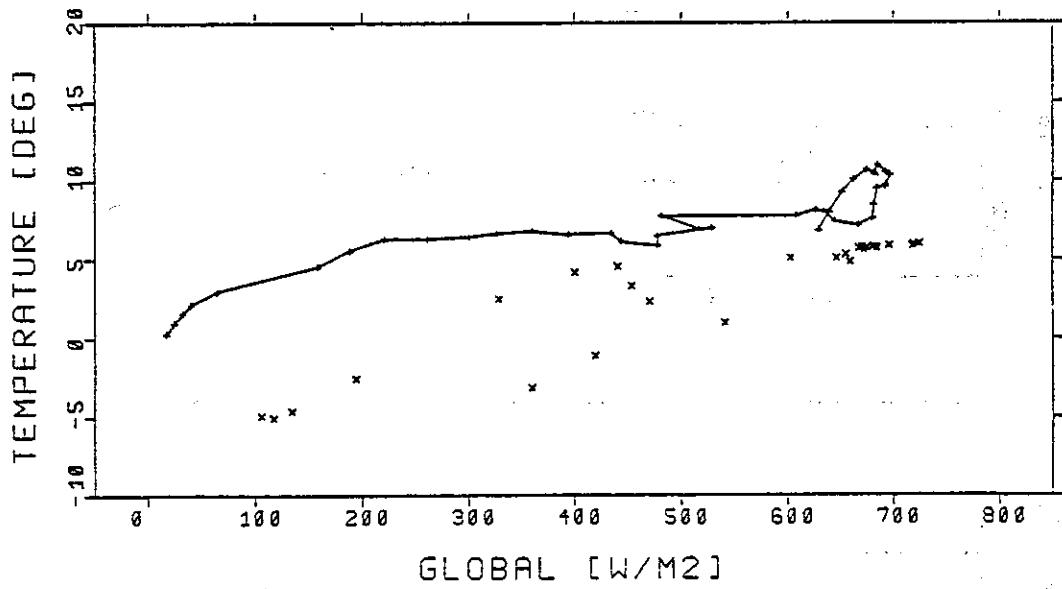
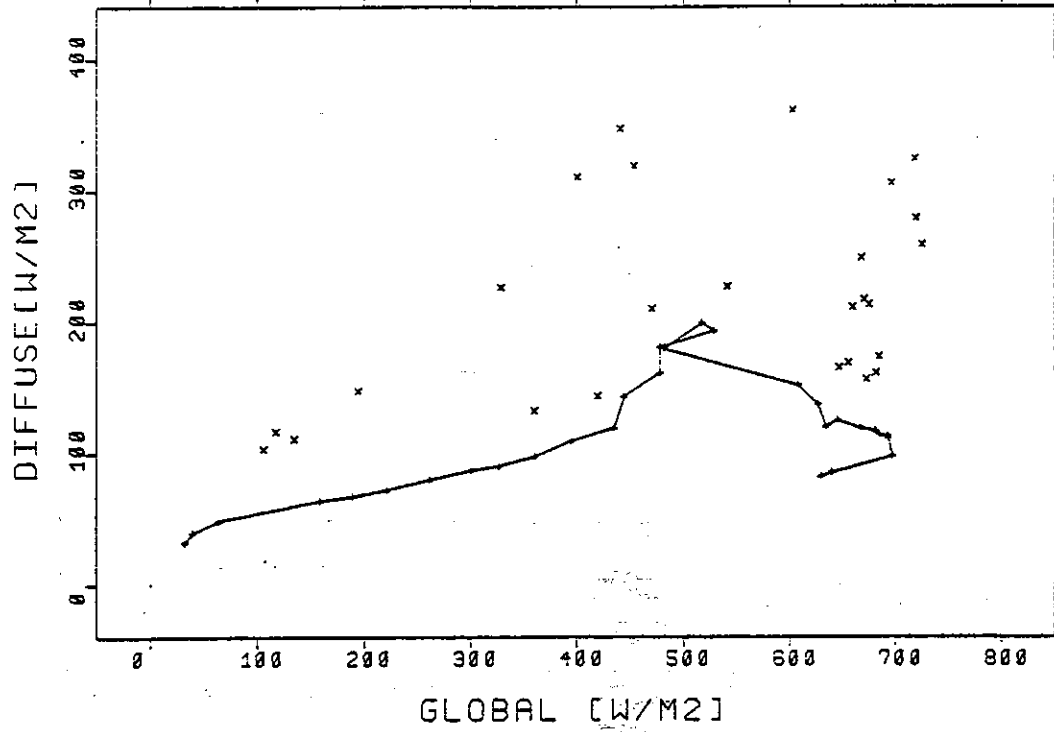

+ MAR-5-80
 x MAR-6-80

Figures 3a + 3b: Diffuse radiation and instrument temperature as a function of the global radiation.

742276

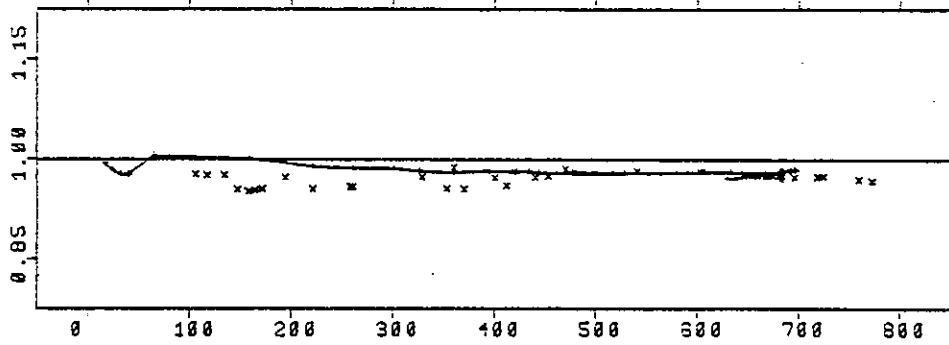

752438

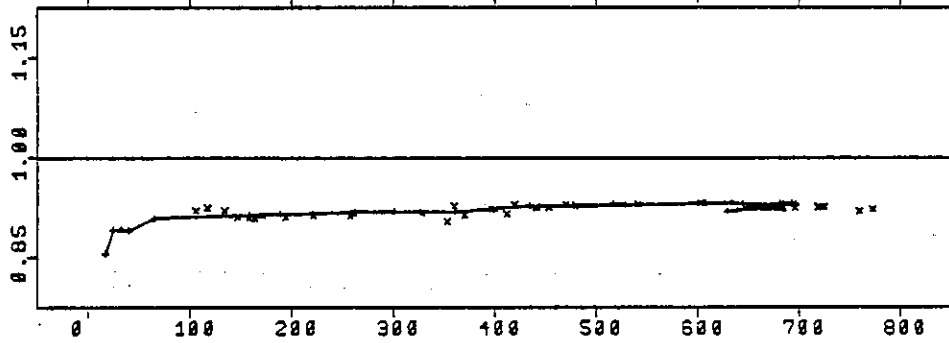

763000

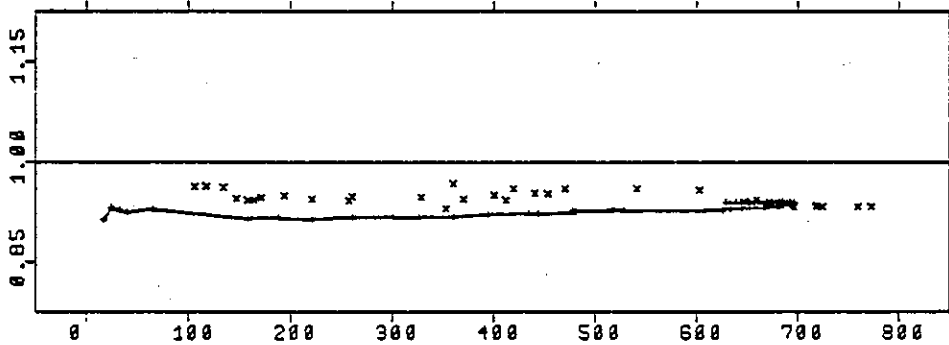

773656

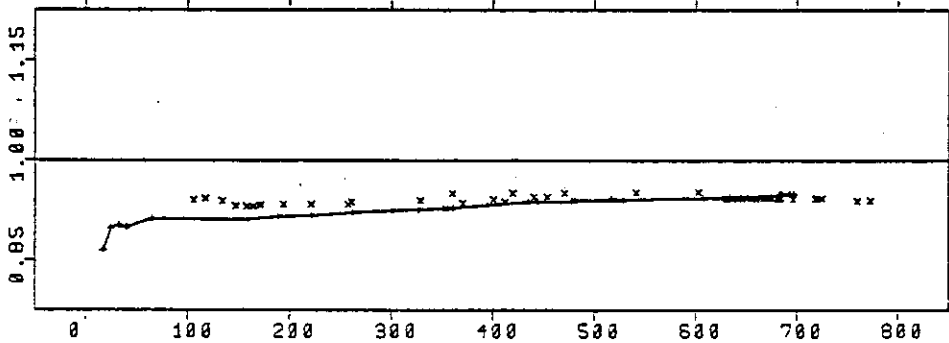

+ MAR-5-98
 x MAR-6-88

Figures 4a-4d: Ratio of Kipp-Zonen pyranometer to the WRC standard as a function of global radiation. (Wm^{-2})

773992

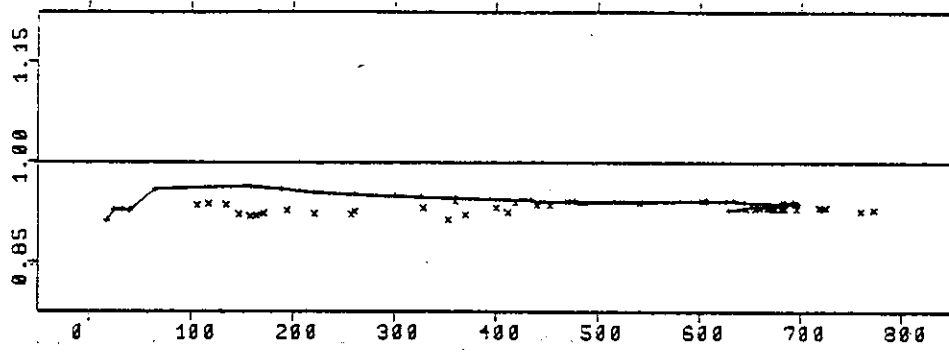

774120

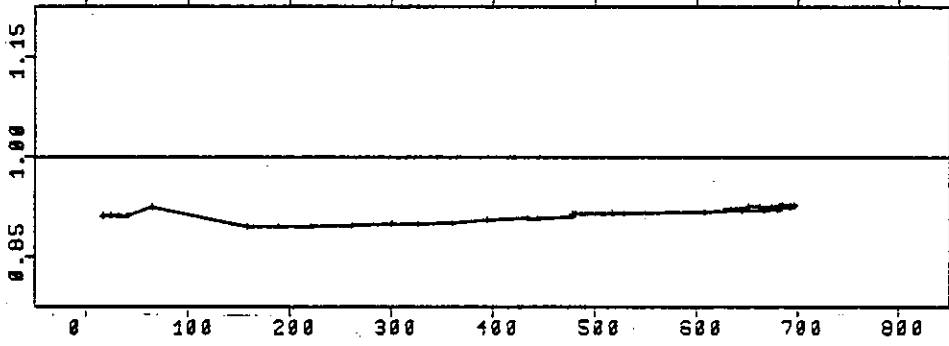

784750

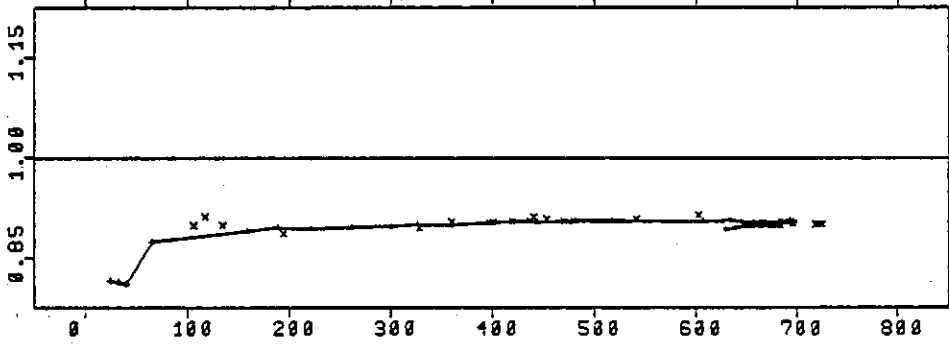

785017

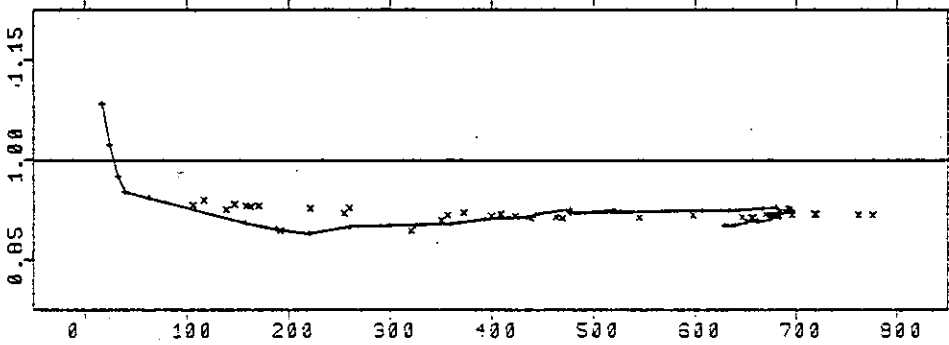

+ MAR-5-80
 x MAR-6-80

Figures 4e-4h: Ratio of Kipp-Zonén pyranometer to the WRC standard as a function of global radiation. (Wm^{-2})

785047

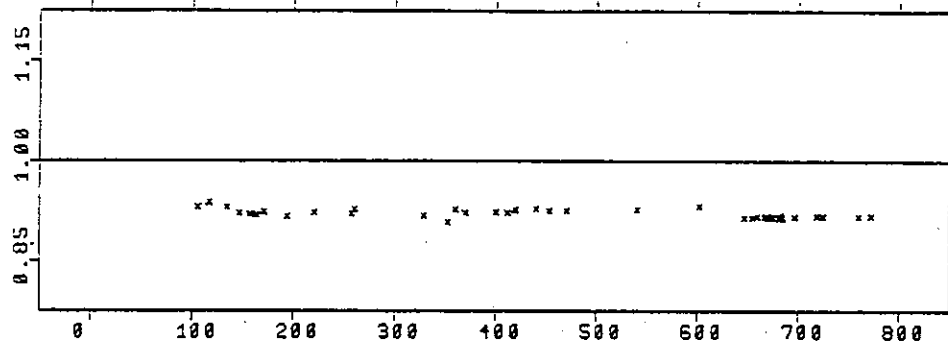

795967

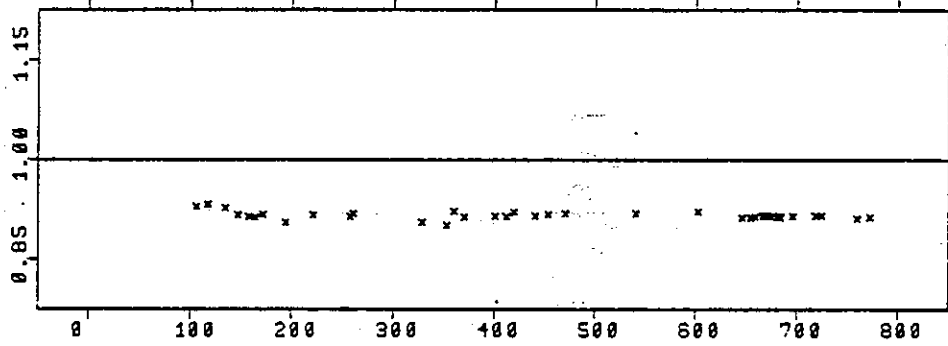

MOH154

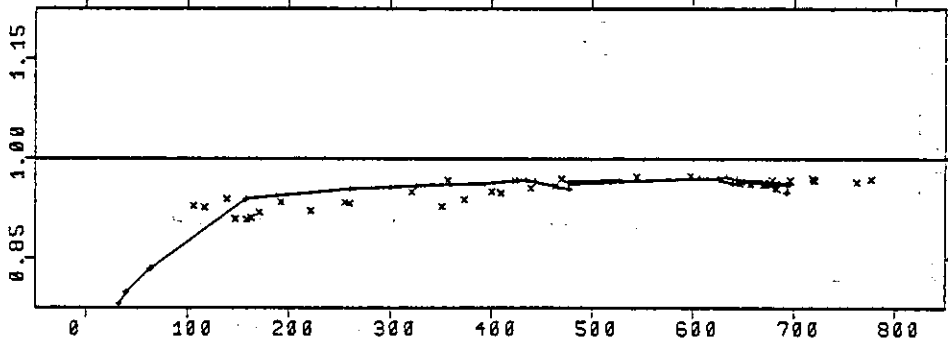

2508

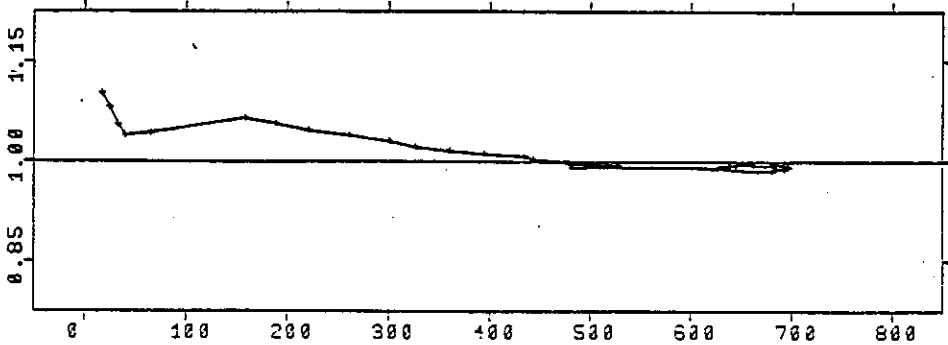

+ MAR-5-80
 x MAR-6-80

Figures 4j-4m: Ratio of Kipp+Zonen pyranometer to the WRC standard as a function of global radiation, Wm^{-2} .

14806F

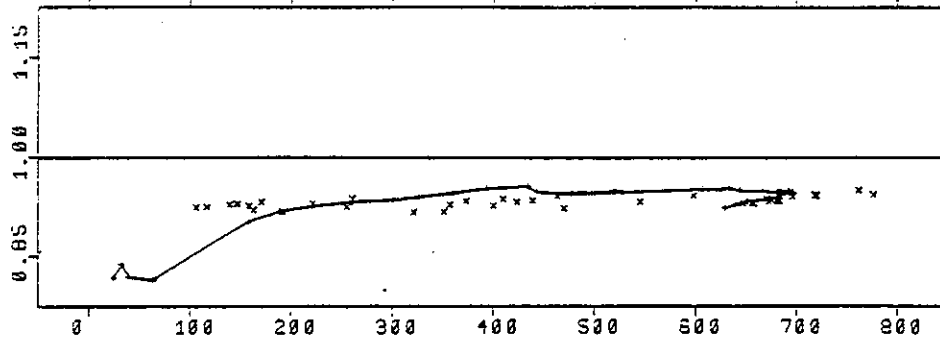

15834F

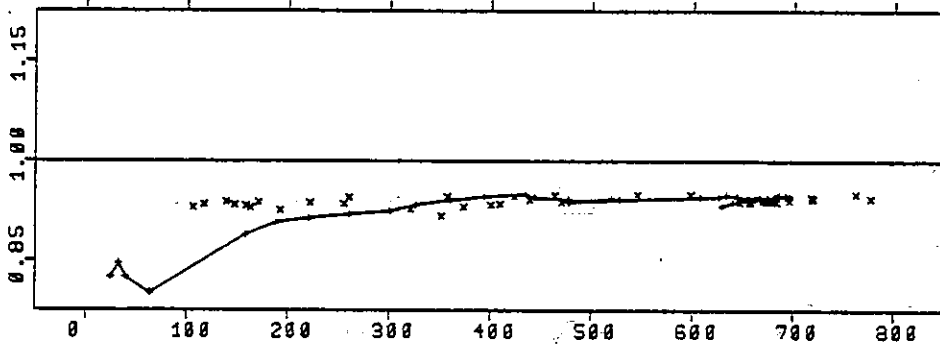

16692F

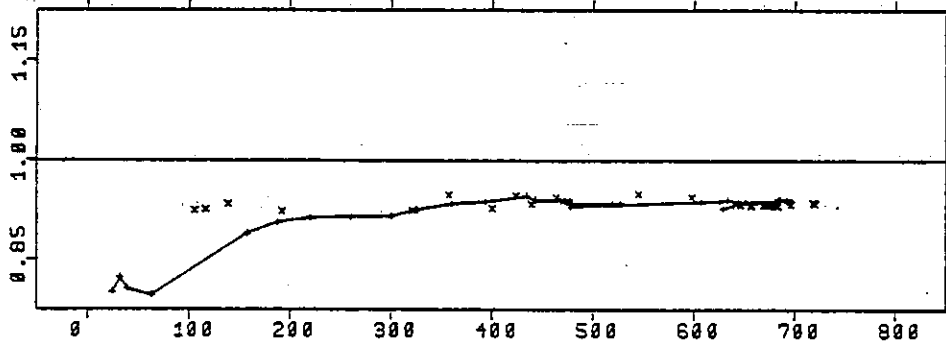

17750F

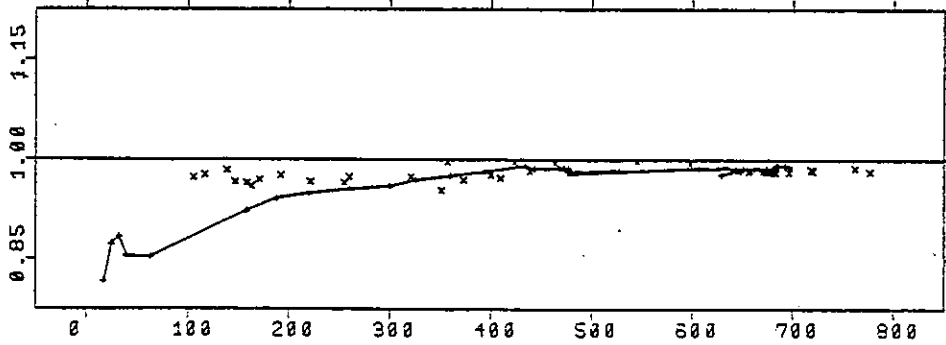

+ MAR-5-80
 x MAR-6-80

Figures 5a-5d: Ratio of Eppley pyranometer to the WRC standard as a function of global radiation. (Wm^{-2})

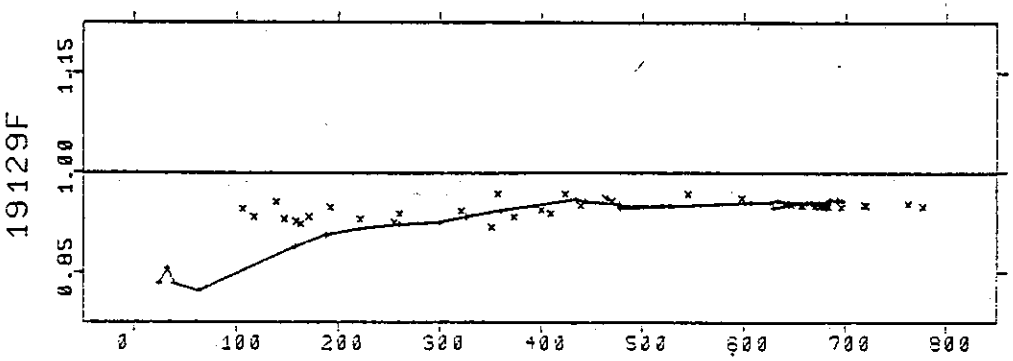
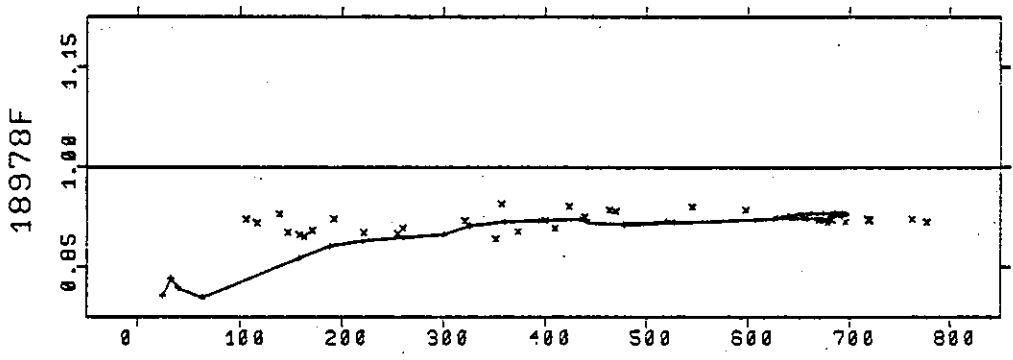
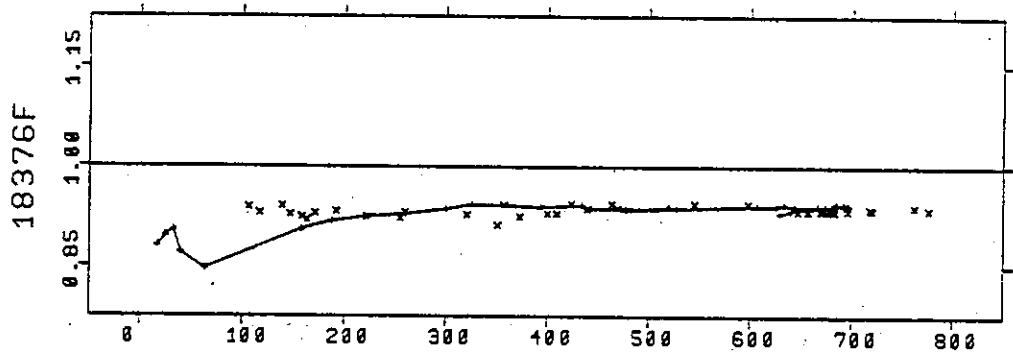
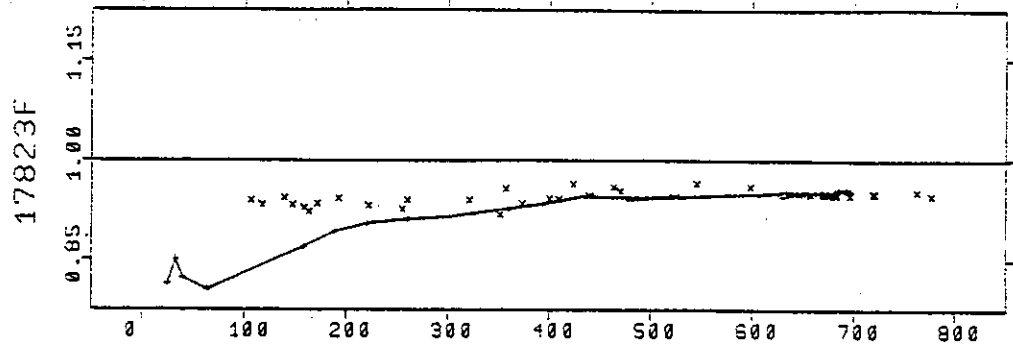

+ MAR-5-88
 x MAR-6-88

Figures 5e-5h: Ratio of Eppley pyranometer to the WRC standard as a function of global radiation. (Wm^{-2})

19222F

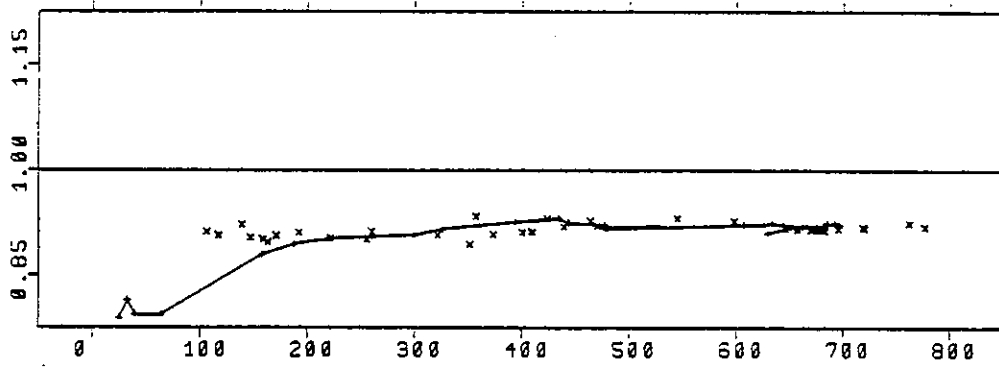
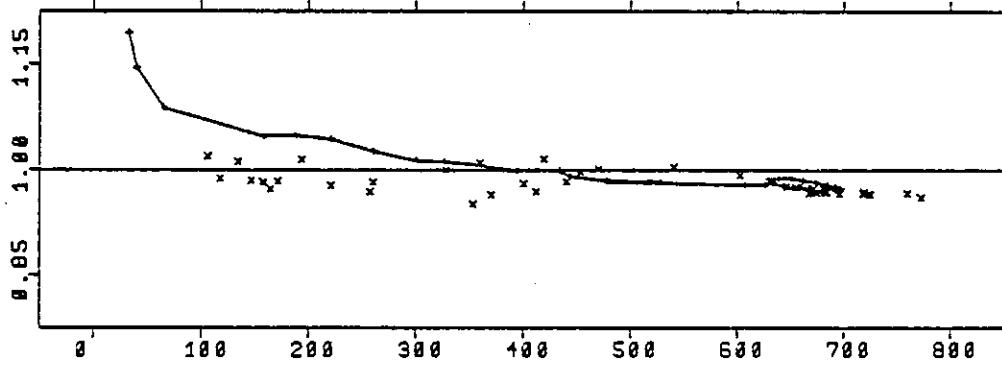

Figure 5j: Ratio of Eppley pyranometer to the WRC standard as a function of global radiation. (Wm^{-2})

1626



+ MAR-5-88
x MAR-6-90

Figure 6: Ratio of Schenk pyranometer to the WRC standard as a function of global radiation. (Wm^{-2})

Contribution of the U.K. Participants

The cosine responses of Kipp solarimeters have been measured indoors under artificial illumination by the U.K. Meteorological Office. The results shown in Figs. X and Y indicate significant differences between the CM2 and CM5 models. Errors of up to 14 % are evident at low solar altitude angles and azimuthal symmetry is poor.

Copyright held by the U.K. Meteorological Office

Kipp CM2 (2508) Linearity Normalised at 50 mW cm⁻²

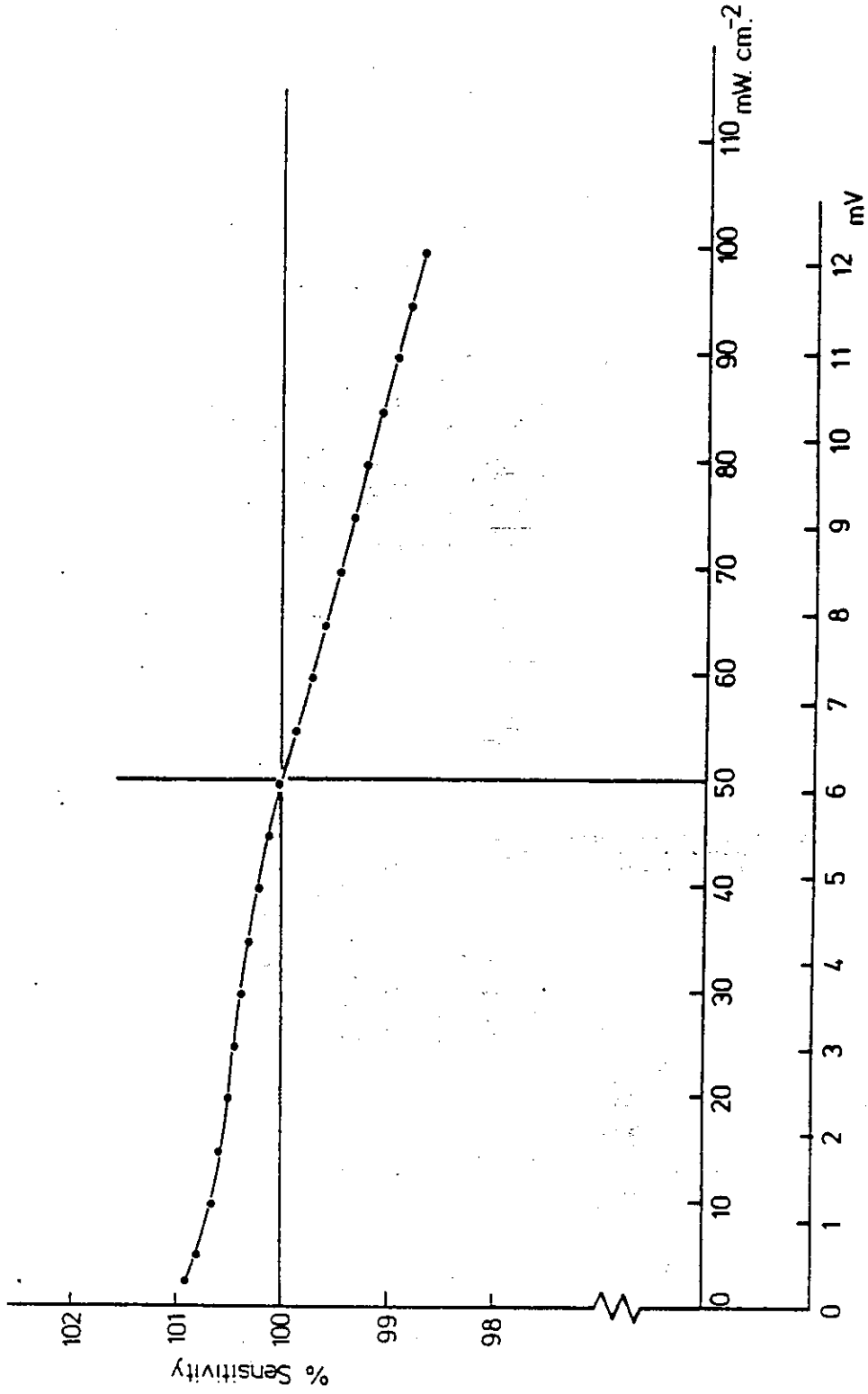

Combined Azimuth and Elevation Response
(Percentage difference from theoretical response
relative to the zenith measurement)

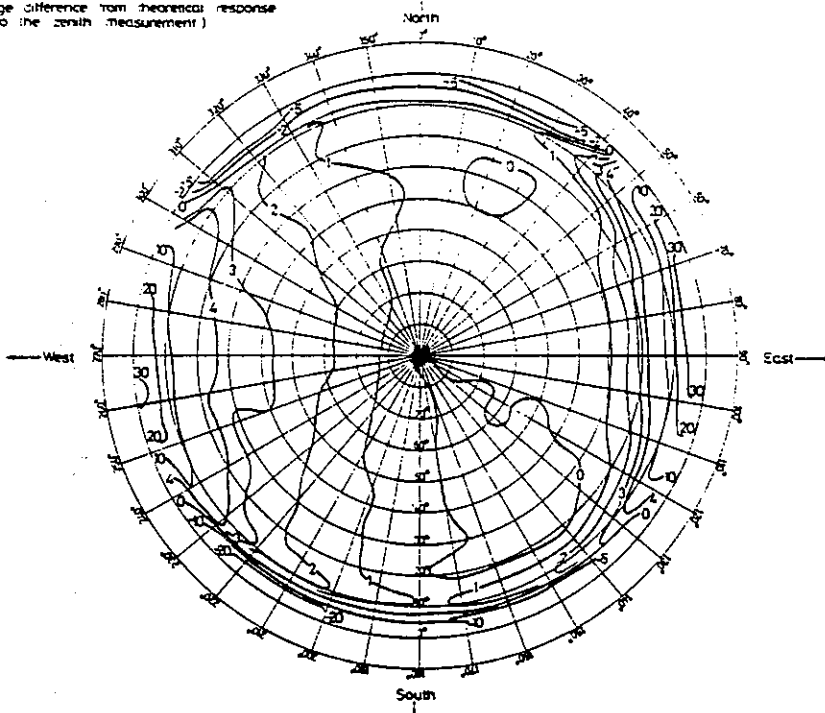

Solarimeter CM 2 (2508)

Combined Azimuth and Elevation Response
(Percentage difference from theoretical response
relative to the zenith measurement)

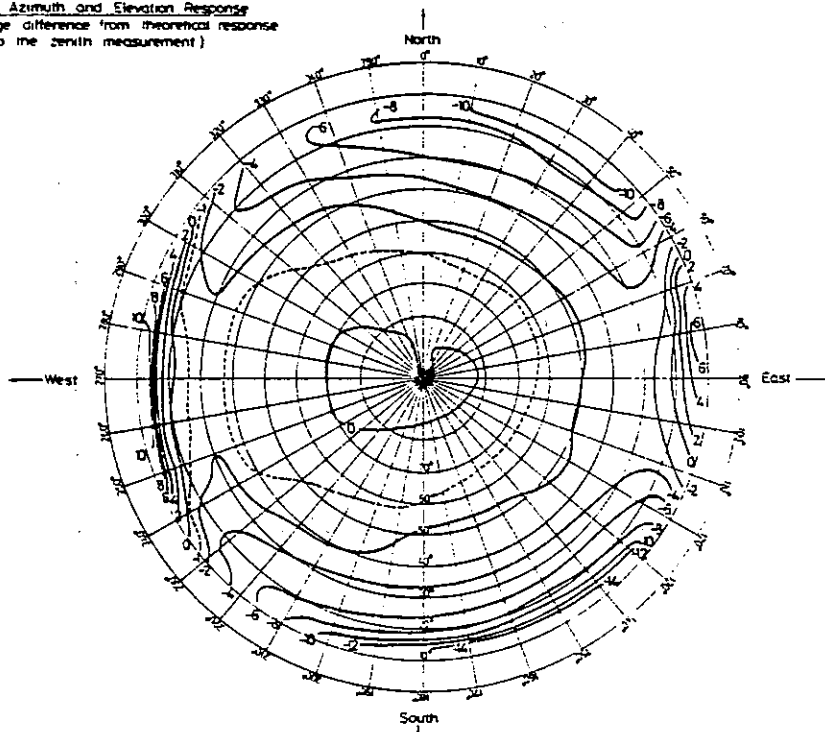

Solarimeter CM 5 (763154)

APPENDIX E

**Report on Calibration Techniques for Pyranometers:
World Radiation Center, Davos, Switzerland, 1981**

by

Claus Fröhlich
Physico-Meteorological Observatory
Post Office Box 173
CH-7260
Davos Dorf
Switzerland

REPORT ON CALIBRATION TECHNIQUES FOR PYRANOMETERS

The discussions of the results of the ad hoc comparison of pyranometers in March 1980 at Davos concentrated mainly on the search for explanations of the systematic differences found. Part of the discrepancies have been explained in the mean time, however, the problems are not yet solved completely.

The status is now the following:

- Differences between the shading technique at low angles and the dome calibrations have been found by Eppley Laboratory;
- The use of IPS and WRR respectively yield a difference of 2.2%;
- Further comparison of Kipp+Zonen instruments calibrated by the French and the British Meteorological Services have been conducted during and after the International Pyrheliometer Comparisons at Davos and have confirmed the systematic difference between the Davos standard and instruments calibrated by other institutes or manufacturers;
- Tests of different calibration methods indicate that the classical shading technique is not always the most reliable method: for the Davos standard for instance, it seems that this technique results in a calibration yielding readings which are about 2.5% higher than one would get with other methods.

In the following, this last item will be described in some detail. For the calibration of a pyranometer under natural conditions, i.e. with the radiation from the sun and sky as source, this radiation input has to be determined accurately. The vertical component of the direct solar

radiation can be deduced from pyrliometric measurements and the solar elevation either calculated from the ephemeris or measured. The diffuse part of the radiation is normally determined with the classical shading technique by the instrument to be calibrated itself. A second, continuously shaded instrument, however, could also be used. The advantage of this technique is obvious: the operating condition of the instrument to be calibrated remains constant and the accuracy of the calibration factor of the shaded instrument is not very critical, as on a clear day, the diffuse part is at maximum only 10% of the global radiation. Further, variations in time are not very critical as the diffuse and direct components are determined simultaneously with the measurement of the instrument to be calibrated and not one after the other. The results of such a test for the Davos standard and the Kipp+Zonen instrument from Carpentras are summarized in table 1. The results confirm the general findings of the ad hoc comparison in March, especially the dependence of the ratio Kipp+Zonen/Davos standard on the intensity. The influence of the classical calibration technique on the factor determined is at reasonable solar elevations about +2.5 % for the Davos standard and about -0.5% for the Kipp+Zonen instrument. At low intensities the effect is much more pronounced: +4.8% and -3.8% respectively. However, as calibrations at our institute are only made at solar elevations higher than about 30°, the systematic error seems to be limited to a maximum of 2.5 %. More investigations in this field are needed and have to be extended to other types of pyranometers.

Together with the findings of the Eppley Laboratory, it seems that most of the differences can be explained consistently but it means, that the different calibration procedures used have to be reviewed critically and tested in detail experimentally. Therefore, this should be one of the most important objectives of the planned pyranometer tests organized by IEA Task III and V in cooperation with the WRC Davos during summer 1981.

C. Fröhlich

Solar elevation in degrees	Vertical component of the sun (S_y) in Wm^{-2}	Diffuse radiation (S_p) in Wm^{-2}	Pyranometer reading (S_p) in Wm^{-2} and ratio $S_p/(S_y + S_D)$ Davos-Standard K+Z Carpentras	Ratio K+Z/Davos
29.0	462.6	42.1	517.0 1.024	0.971
30.0	478.3	41.2	533.9 1.028	0.970
15.2	208.3	29.9	249.8 1.049	0.918

Table 1: Comparison of different calibration techniques. For the calculation of the pyranometer readings, the calibration factors determined by WRC and Carpentras respectively are used, for the K+Z corrected for temperature with -0.17% per degree.

APPENDIX F

**Final Summary Report:
Round Robin I Calibration of Selected Pyranometers
from 1980 Davos Comparison**

by

Gene Zerlaut
DSET Laboratories, Inc.
Post Office Box 1850
Black Canyon Stage
Phoenix, Arizona 85029
U.S.A.

FINAL SUMMARY REPORT

ROUND ROBIN I CALIBRATION OF SELECTED PYRANOMETERS FROM 1980 DAVOS COMPARISON

by

G. A. Zerlaut
DSET Laboratories, Inc.
Phoenix, Arizona 85029

Submitted to: Dr. Kent A. Reed
National Bureau of Standards

For: Operating Agent, IEA Task III Performance
Testing of Solar Collectors

INTRODUCTION

As a result of the radiation measurements workshop held at PMOD in Davos, Switzerland on March 5, 6, 1980 (Ref. 1), and the author's trip report of that meeting (Ref. 2), a Round Robin Calibration Experiment was conducted employing the following three instruments that were in the Davos comparisons:

1. Kipp and Zonen SN 774120, furnished by Dr. H. D. Talarek of Kernforschungsanlage Jülich (D)
2. Eppley PSP SN 14806, furnished by Mr. Elmer Streed of the National Bureau of Standards (US)
3. Eppley PSP SN 19129, furnished by Mr. G. A. Zerlaut of DSET Laboratories, Inc. (US)

The Round Robin calibrations were performed in order by DSET Laboratories, then by E. Flowers, Solar Radiation Facility (NOAA, Boulder), and finally by J. Hickey of The Eppley Laboratories. These calibrations will henceforth be referred to as Round Robin I, since a second, more comprehensive Round Robin of the "Davos instruments" is now underway.

It was agreed that each of the three laboratories would utilize its most common practice in calibrating the three pyranometers, and that the calibrations would, insofar as practical, be referenced to instruments whose calibrations were traceable to previously compared absolute cavity pyrheliometers, or would be directly calibrated by such absolute cavities by the shading disk method.

In DSET's case, field instruments are calibrated by the shade method directly to the Eppley Model HF cavity at a tilt defined by normal incidence for the particular season. This is done to conform to the need to calibrate under the end-use conditions of solar collector testing on altazimuth, follow-the-sun mounts. We learned as early as 1976 that transfer of calibrations from a working standard calibrated at 0° Horizontal (especially on the basis of a weighted integral) to a pyranometer at a 45° tilt, for example, could cause the propagation of errors as great as 3%.

DISCUSSION

DSET/NOAA Results

Although the techniques were slightly different, and the time of year was different, the instrument constants derived by DSET and SRF/NOAA are in good agreement with each other for the Eppley PSP pyranometers in three test modes and for the Kipp and Zonen in one test mode. The summary data furnished by Flowers (from Table 1, Ref. 4) and corresponding data submitted by the author (from Tables 2 and 5, Ref. 3) are presented together in Table I.

Excellent agreement between labs was obtained for the PSP's when calibrated against absolute cavity pyrhemometers by the shading disk method, even though DSET utilizes a 30 sec/30 sec and NOAA a 5 min/6 min for a shaded/unshaded sequence. The DSET shading calibrations were performed at an average solar elevation of 64° (as opposed to 60° for the NOAA measurements).

The agreement between laboratories at tilt (the DSET data are taken from Table 2 of Reference 3) was surprisingly good insofar as the DSET results were obtained at 30° from the horizontal by the shading disk method and the NOAA results were at a tilt of 40° with the instrument constant transferred from a reference pyranometer.

The most interesting results are the unusually good agreement between DSET and NOAA obtained at horizontal for all three instruments referenced against pyranometers at both labs. The DSET data are taken from Table 5 of Reference 3. In this analysis, the NBS instrument (14806) is referenced against the "horizontal shading disk" calibration of the DSET instrument (19129), the DSET instrument (19129) is referenced against the "horizontal shading disk" calibration of the NBS instrument (14806) and the value for the KFA/KZ instrument (774120) is the average obtained when referenced against 19129 and 14806. The average algebraic deviation was 0.25%, and the standard deviation of the population $n=7$ was $\pm 0.286\%$.

DSET/EPPLEY Results

The agreement between DSET and Eppley results is presented in Table 2. The disparity between the horizontal shading disk measurements may be due in part to the large differences in solar elevation -- dictated by the time of year the instruments were available at the respective laboratories. It is difficult to assess the differences between the horizontal calibrations at DSET (versus the shading disk calibration of the NBS PSP) and the Eppley integrating hemisphere calibrations (versus their reference SN 13055). We believe it to be due in part to sensitivity deterioration of DSET's PSP SN 19129 (see Figure 2). From Table 3, it is noted that only 1.8% separates the average value of 9.84 obtained by DSET and NOAA and the nameplate calibration of 10.02 furnished by Eppley for the NBS instrument SN 14806. It is interesting to note that the original calibration of SN 14806 was to the IPS scale, which is about 2.1% higher than the values now utilized by referencing to the absolute scale (WRR).

Better agreement was obtained by Eppley and DSET in normal incidence calibrations of SN 19129 by the shading disk method (Table 2). The DSET data were obtained at a tilt of 30° (summer months) and the Eppley data were obtained at a tilt of 60° (early winter). On return to DSET, PSP SN 19129 was recalibrated by the shade method at normal incidence, and a value of 10.33 $\mu\text{V}/\text{Wm}^{-2}$ was obtained.

The average deviation between DSET and Eppley calibrations was 1.23% and the standard deviation σ for a population of $n=6$ was $\pm 2.30\%$.

Tilt and Cosine Effects

All shading disk calibrations performed on the DSET PSP SN 19129 were normalized to 25°C and 0° Horizontal. The data are presented in Table 4 and are plotted in Figure 1. These data represent an aggregate of the tilt effects and deviation from the cosine law. In any case, it is observed that the maximum deviation can be approximately 1.7% between a tilt of 30° and 60°. This is the exact range of tilt experienced when testing solar collectors on an altazimuth mount throughout the year -- winter to summer months. The greatest portion is attributed to deviations from cosine law on the basis that tilt effects are quite small for Eppley Model PSP pyranometers (Ref. 4, 6), being on the order of 0.5% or less.

Aging Experience

The deterioration in instrument sensitivity of Eppley Model PSP's is observed in pyranometers continuously exposed outdoors in the desert at DSET's

Table 1

SUMMARY OF DSET/NOAA CALIBRATION RESULTS

Test Mode	Lab	Reference Mode	Eppley PSP		Kipp & Zonen (KFA) SN 774120
			(DSET) SN 19129	(NBS) SN 14806	
Horizontal	DSET	(Shade)	10.427	9.843	$\mu\text{V}/\text{Wm}^{-2}$ --
Shade Disk	NOAA	(Shade)	<u>10.500</u>	<u>9.840</u>	--
60° Sun El.	%V		-0.70	+0.03	
Horizontal	DSET	(PSP)	10.570	9.910	12.820
(Ref. Pyra.)	NOAA	(PSP)	<u>10.588</u>	<u>9.889</u>	<u>12.873</u>
	%V		-0.17	+0.21	-0.41
Tilt - 30°	DSET	(Shade)	10.470 *	9.837	--
40°	NOAA	(PSP)	<u>10.496</u>	<u>9.884</u>	--
	%V		-0.25	-0.47	

* Normalized to 25°C

Table 2

SUMMARY OF DSET/EPPLEY CALIBRATION RESULTS

<u>Test Mode</u>	<u>Lab</u>	<u>Ref.</u>	<u>DSET</u> <u>SN 19129</u>	<u>NBS</u> <u>SN 14806</u>	<u>Kipp & Zonen</u> <u>SN 774120</u>
Horizontal (Shade Disk)	DSET	60° E1	10.427 *	9.843	--
	EPPLEY	25° E1	<u>10.290</u> +1.31%	<u>9.290</u> +5.62%	--
Horizontal	DSET	PSP	10.570	9.910	12.820
	EPPLEY	Hemisphere	<u>10.640</u> -0.66%	<u>10.070</u> -1.59%	<u>13.090</u> +2.06%
Tilt (Normal Incidence)	DSET	30° Tilt	10.41	9.843	--
	EPPLEY	60° Tilt	<u>10.34</u> +0.67	--	--

* $\mu\text{V}/\text{Wm}^{-2}$

Table 3
NAMEPLATE VS. MOST CORRECT CALIBRATION

	Eppley PSPs		Kipp & Zonen (KFA) <u>SM 774120</u>
	<u>DSET</u>	<u>NBS</u>	
	<u>SN 19129</u>	<u>SN 14806</u>	
Nameplate	10.76 $\mu\text{V}/\text{Wm}^{-2}$	10.02	13.70
Horiz. Shade	<u>10.46*</u>	<u>9.84</u>	<u>12.84</u>
	2.8%	1.8%	6.3%

* This pyranometer has degraded to an IC of 10.33 in 6 additional months (now 4% degradation).

Table 4

INSTRUMENT CONSTANT FOR DSET/PSP SN 19129F3
 NORMALIZED TO 25°C AND 0°H

Normal Incidence

Tilt	Original Values		Normalized ic	Variance F
	ic	oc		
35°	10.402	27.8	10.412	
32°	10.432	27.8	10.442	
28°	10.396	28.3	10.406	
32°	10.405	28.9	10.419	
32°		\bar{x}	10.420	1.0004

Horizontal

0°H	10.428	21.1	10.415	1.000
0°H	10.415	23.3	10.410	0.999
0°H	10.429	23.3	10.424	1.001
		\bar{x}	10.416	1.0000

Tilt

10°	10.370	40.0	10.422	
10°	10.388	44.4	10.456	
10°	10.456	26.0	10.458	
		\bar{x}	10.445	1.0027
15°	10.409	38.9	10.457	
15°	10.408	41.0	10.464	
		\bar{x}	10.461	1.0043
30°	10.389	37.8	10.433	
30°	10.432	33.3	10.451	
30°	10.458	44.0	10.525	
		\bar{x}	10.470	1.0052
45°	10.348	26.1	10.351	0.9937
60°	10.291	27.2	10.297	0.9886
		\bar{x}	10.426	

Figure 1. RELATIVE RESPONSE OF PSP SN 19129 AS A FUNCTION OF TILT ANGLE FROM HORIZONTAL AT A SUN ELEVATION OF ABOUT 60°

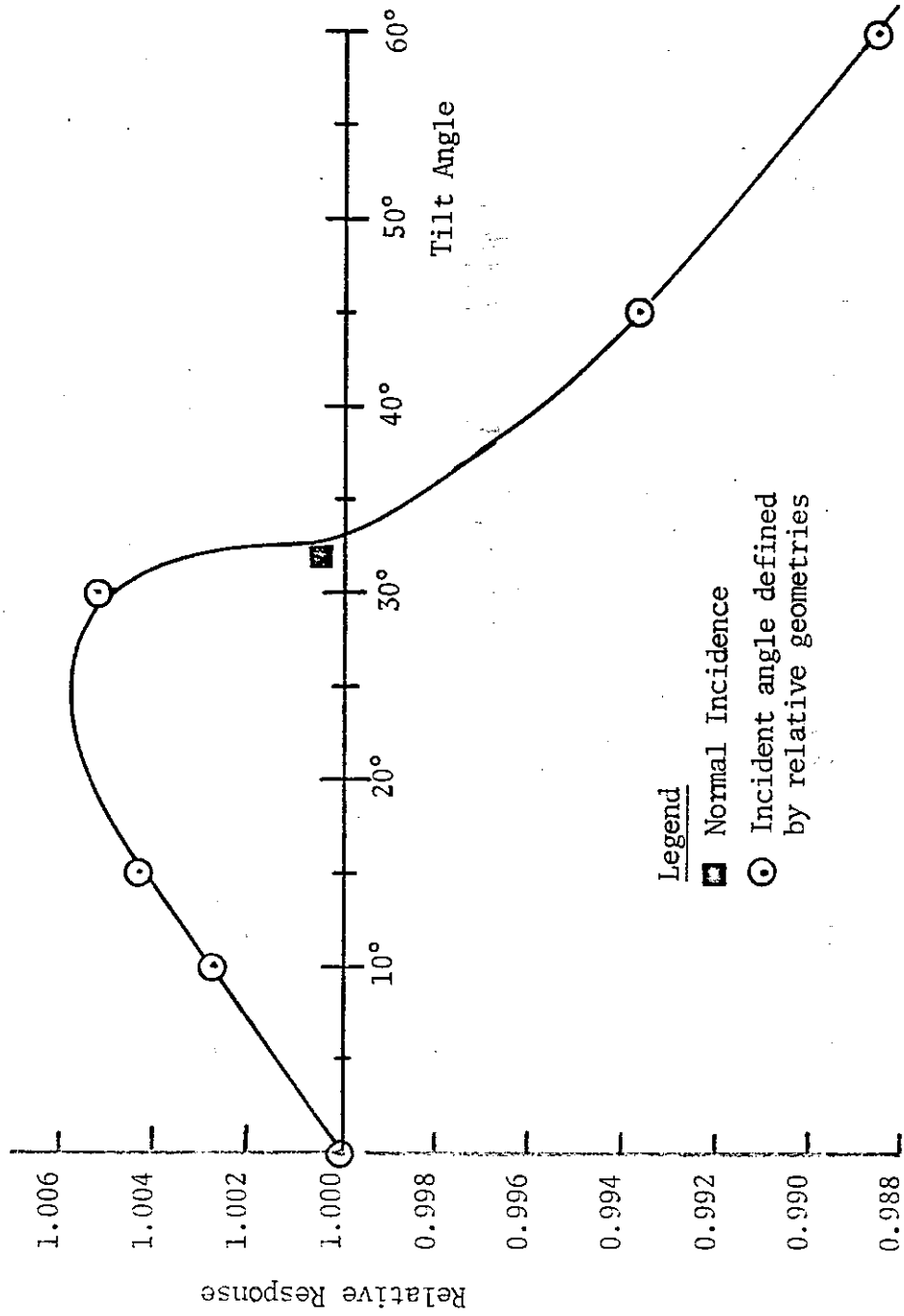

New River facility. The loss in responsivity of SN 19129 (along with four other continuously exposed pyranometers) is shown in Figure 2 as a function of months of exposure. Except for SN 14391, the zero exposure condition represents the Eppley nameplate calibration and all other instrument constants are determined by the shading disc calibration against the HF cavity. After an initial rapid change, the typical PSP appears to suffer a decrease in sensitivity of about 1% per year (with the range being about 0.75 to 1.5%). It should be noted that the temperature response curve is employed to normalize the instrument constant for the temperature at which solar collector performance data are being taken, thus eliminating as much as an additional 1/2% error (the temperature correction curve for SN 19129 is presented in Figure 3).

ANALYSIS OF DAVOS RESULTS

The ratio between the radiation measured by each of the three Round Robin instruments to that measured by the Davos comparisons reference instrument PMOD SN 6703A (Ref. 1) are given in Table 5 along with the new, recalculated ratios derived from the Table 4 values. Even after recalculation based on the best available instrument constants for those three instruments at the time of the Davos comparisons, the average deviation from the reference instrument was 3.1%. While this certainly brings into question the calibration constant of the reference instrument employed at the Davos comparisons, other factors such as disparate fields of view for the arrayed instruments (the instruments were mounted more or less against a North snowbank), disparate temperature compensation curves, and low sun angles for that time of year, could affect the results as well. However, using the temperature compensation curve presented in Figure 3, the corrected, recalculated instrument constant for SN 19129 gives a ratio still no higher than 0.9799 compared to PMOD 6703A.

It is additionally instructive to employ the cosine and temperature compensation corrections for the Davos data as defined by the declination δ of -6.37° and the solar noon sun elevation of 37.1° for Davos ($L=46.5^\circ N$) on the 65th Julian Day (March 5, 1980), and an assumed temperature of $0^\circ C$. These corrections are taken from DSET data and the report by E. Flowers (Ref. 4); they are presented in Table 6. The temperature correction for PSP SN 14806 is unity based on the difference between $26^\circ C$ (the nameplate temperature) and $0^\circ C$ (the assumed temperature at the Davos intercomparisons) as determined by its compensation curve. No correction was made for the Kipp & Zonen instrument since we have no knowledge of the temperature at which the "original" instrument constant was determined.

Figure 2. LOSS OF SENSITIVITY OF PSP PYRANOMETERS AS A FUNCTION OF EXPOSURE AT NEW RIVER, ARIZ

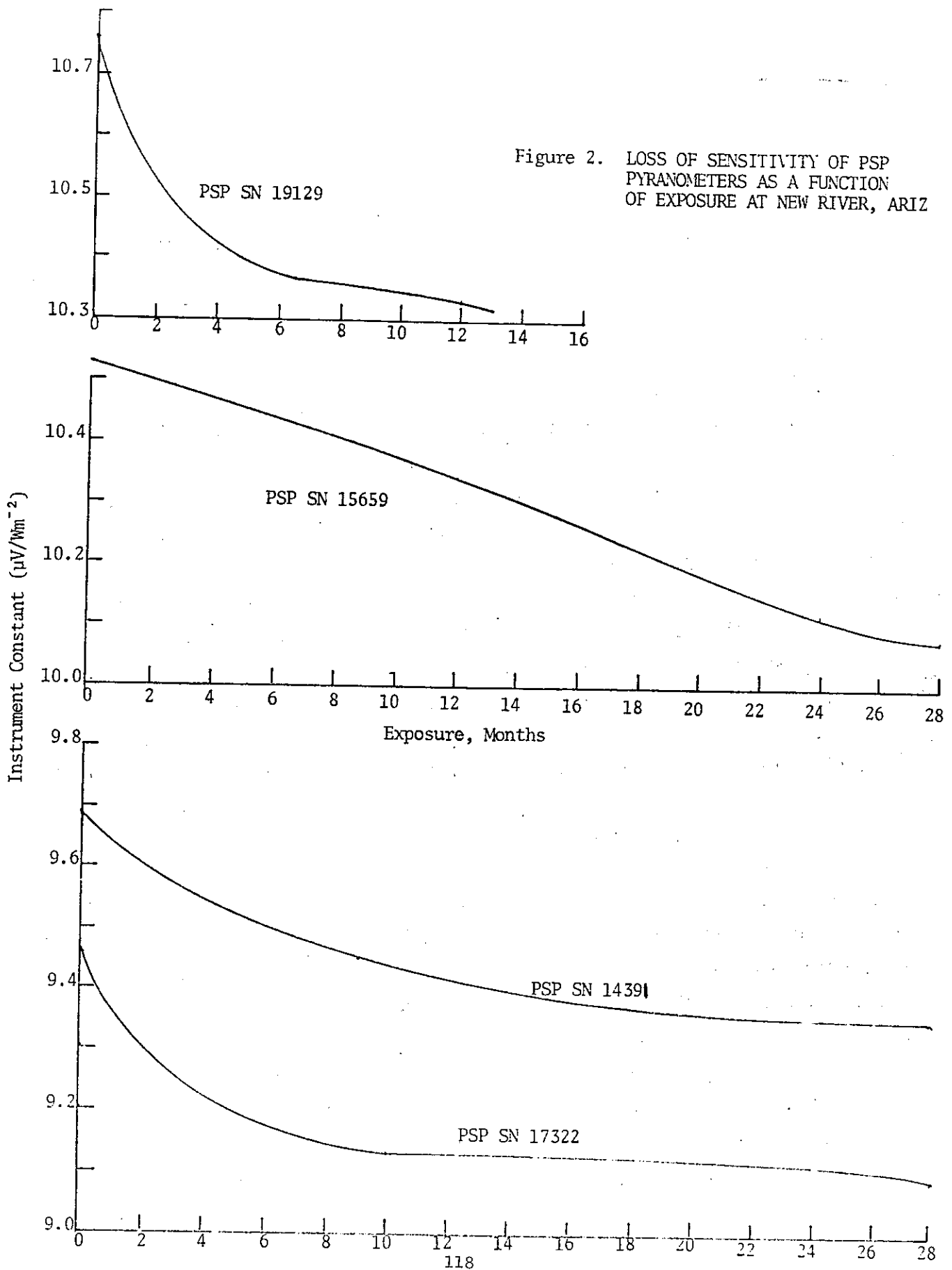

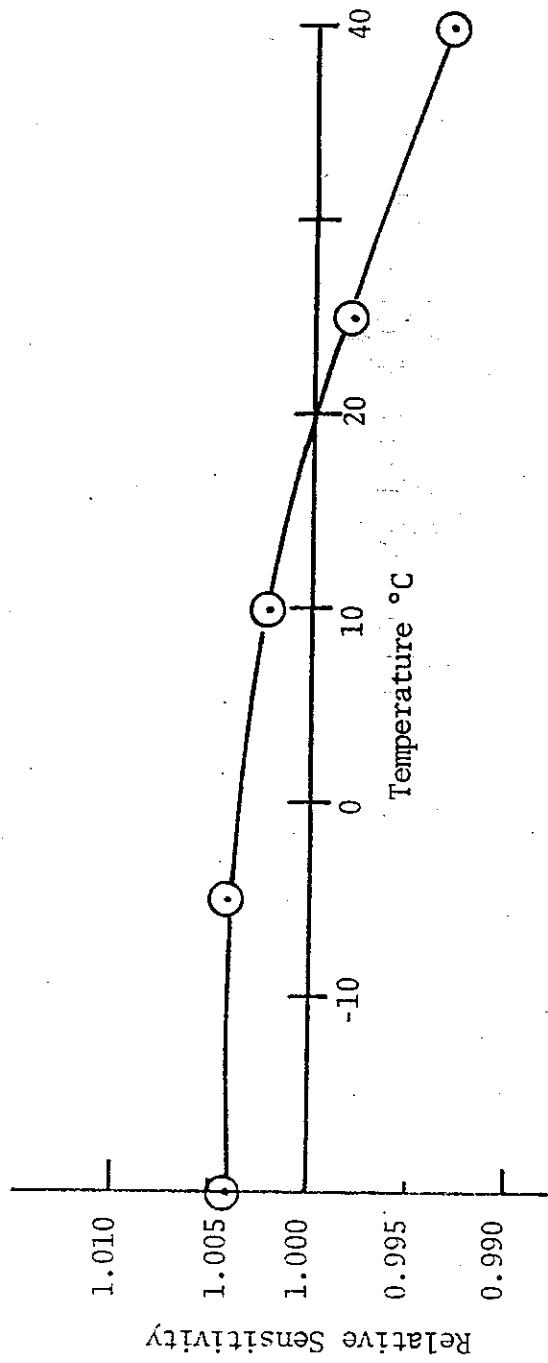

Figure 3. TEMPERATURE DEPENDENCE OF PSP SN 19129

Table 5

RATIO OF ROUND ROBIN INSTRUMENTS TO PMOD 6703A

<u>Instrument</u>	Davos Comp.		Recalculation	
	<u>I.C.</u>	<u>Ratio</u>	<u>I.C.</u>	<u>Ratio</u>
KZ 774120	13.70	0.9159	12.84	0.9772
EP SN 14806	10.02	0.9378	9.84	0.9550
EP SN 19129	10.76	<u>0.9468</u>	10.46	<u>0.9740</u>
		0.9335		0.9687
	$\sigma =$	0.0130	$\sigma =$	0.0098

Table 6

COSINE AND TEMPERATURE CORRECTIONS
TO THE DAVOS RATIOS

<u>Instrument</u>	<u>Original Davos</u>	<u>Cosine Corrected</u>	<u>Cosine and Temp. Corrected</u>
KZ 774120	0.9159	0.9834	0.9834 *
EP SN 14806	0.9378	0.9871	0.9871
EP SN 19129	<u>0.9468</u>	<u>0.9768</u>	<u>0.9827</u>
	0.9335	0.9824	0.9844
	$\sigma =$	0.0130	0.0043
			0.0019

* Temperature correction not applied

We have thus shown that the agreement between the three instruments compared to PMOD 6703A can be significantly improved by utilizing carefully determined instrument constants, and can be further improved by employing cosine and temperature correction. As will be seen from column 4 in Table 6, the three "corrected" instruments agree to within 0.2% with each other, although they

still differ from PMOD 6703 by about 1.6%. Not knowing the temperature and cosine response relationships of PMOD 6703, we cannot perform further analyses at this time.

CONCLUSIONS

1. Excellent agreement between calibration results of NOAA and DSET for the two Eppley PSP instruments, and for the pyranometer transfer calibrations of the Kipp and Zonen instrument, indicates that the discrepancies observed between the Eppley instruments 14806 and 19129 and the PMOD reference pyranometer can be explained only in part by the fact that incorrect instrument constants were employed at Davos (the instruments presumably having lost sensitivity since manufactured). The new instrument constants are approximately 2 and 3% lower for 14806 and 19129, respectively, and about 6.5% lower for the Kipp and Zonen 774120 than the value employed in the Davos comparisons.

2. Analysis of the DSET and NOAA results indicates the sensitivity of transferring calibrations from one pyranometer to another under conditions where small errors due to deviations from cosine response, failures to account for the temperature dependence of instrument constants, small tilt effects and disparities in hemispherical enclosures, can all conspire to cause significant errors when employing even the best pyranometers available for precision instantaneous measurements of solar irradiance. Analysis of these uncertainties has shown that the probable error can exceed $\pm 2\%$ and the possible error can exceed $\pm 4\%$. Indeed, we believe that such uncertainties and errors in pyranometer instrument constants account for a large proportion of the laboratory-to-laboratory disagreements in testing the same, or identical, solar collectors -- differences that are not uncommonly between 4 and 8% (or, double the probable and possible errors).

3. Employing shading disk calibrations of pyranometers directly against the Model HF cavity pyrhemometers every 3 to 5 months, at the tilt defined by the season (in consonance with the conditions employed in collector testing), we have been able to maintain a precision of approximately 0.995 and an accuracy of from 0.985 to 0.99 in the global measurement of solar flux incident on a collector surface.

4. Because of the synergistic accumulation of errors that is possible, pyranometer instrument constants derived for meteorological purposes, that is, for resource assessment (when weighted for diurnal and seasonal angles of

incidence) should not be employed in the precision measurement of solar radiation for the purposes of performing thermal performance tests of solar collectors -- unless we are willing to accept uncertainties of $\pm 3\%$ in the optical efficiency values due solely to the measurement of solar irradiance. Pyranometers destined for solar collector testing should be calibrated not less often than every 6 months either directly by the shading disk method, or by transfer from a working standard that has been thoroughly characterized at the tilt, seasonal sun elevation, and the range of incident angles of test, that will be employed. The temperature dependence of the incident calibration must be accounted for at all steps in the process from calibration of the transfer standard to the actual field measurement of instantaneous solar irradiance.

5. For incident angle modifier testing (such as required by ASHRAE Standard 93-77), the pyranometers should be thoroughly characterized as to azimuth and cosine response at tilt for the season of record. In this respect, the American Society for Testing and Materials, through the auspices of ASTM Committee E44 on Solar Energy Conversion, has prepared five draft standards pertaining to calibration of pyranometers and pyr heliometers, two of which will become published standards before Summer of 1981. They are listed in Exhibit 1.

ACKNOWLEDGEMENT

The author wishes to thank Mr. Ed Flowers of NOAA and Mr. John Hickey, of The Eppley Laboratory for their contribution to this Round Robin and for their helpful suggestions. The author is also indebted to Mr. Jerry Maybee and Mr. William Noorlag, both of DSET, for their toil in the performance of the many shading disk measurements required.

References

1. Results of a Pyranometer Comparison, H. D. Talarek, KFA-Jülich, ed., IEA Solar R&D Report prepared by WRC/PMOD Davos, June 1980.
2. Trip Report, IEA-Task III Solar Measurements Experts Meeting, G. A. Zerlaut, March 5, 6, 1980.
3. Test Report, Pyranometer Calibration, G. A. Zerlaut, August 28, 1980.
4. Preliminary Report on Tests by SRF/NOAA on Three Pyranometers from the IEA Comparisons in Davos, E. Flowers, SRF/NOAA, September 27, 1980.
5. Report of Tests of Three Pyranometers Which Were Included in the March 1980 IEA Intercomparisons at Davos, Switzerland, J. Hickey, The Eppley Laboratory, Inc., January 20, 1981.
6. Anderson, H. E. B., et al, Statens Provingsanstalt, Report SP-RAPP 1981:1, Boros, Sweden, January 8, 1981.

Exhibit 1

		<u>Ballot Level</u>
102R4	Calibration of Secondary Reference Pyrheliometers and Pyrheliometers for Field Use	Society
103R3	Transfer of Calibration from Reference to Field Pyranometers	Society
104R3	Calibration of Reference Pyranometers with Axis Vertical by the Shading Method	Subcommittee
141R1	Calibration of Reference Pyranometers with Axis Tilted by the Shading Method	Subcommittee
142R1	Calibration of Reference Pyranometers with Respect to Cosine, Tilt and Azimuth Errors	Subcommittee

APPENDIX G

**Report on Tests by SRF/NOAA on Pyranometers from the IEA
Comparisons in Davos, March 1980**

**Part I: Tests on 3 Pyranometers
Part II: Description of Test Methods
Part III: Tests on IEA Pyranometer, January-March 1981
Part IV: Revised Analyses**

by

Edwin Flowers and Rudy Haas
National Oceanic and Atmospheric Administration
Solar Radiation Facility R32x2
325 Broadway
Boulder, Colorado 80303
U.S.A.

REPORT ON TESTS BY SRF/NOAA ON PYRANOMETERS FROM THE IEA
 COMPARISONS IN DAVOS, MARCH 1980
 Edwin Flowers & Rudy Haas, Solar Radiation Facility
 Boulder, Colorado

PART I: Tests on 3 pyranometers, August-September 1980

The three pyranometers (Eppley PSP 19129F3-DSETL, Eppley PSP 14806F3-NBS, and Kipp 774120-FRG) were received from DSETL on August 14, 1980 and sent on to Eppley Laboratories on September 24. Four basic tests were performed on the instruments at Boulder:

1. Calibration on the horizontal by comparison with the NOAA reference pyranometer.
2. Calibration at 40° tilt, south facing by comparison with a NOAA secondary reference pyranometer.
3. Calibration on the horizontal by the shade method with the NOAA cavity radiometer (pyrheliometer) as reference.
4. Determination of relative response at 20°, 30°, 40°, 50°, 60°, and 70° tilt, south facing.

In addition, a temperature response test was run on the Kipp pyranometer. Table I summarizes the results of the tests.

		TABLE I			
TEST	PERIOD 1980		EP19129	EP14806	KIPP774120
1. Horizontal	Aug.15-Sep.3	N	17/1382	17/1393	17/1367
		C*	10.588	9.889	12.886
		R	0.984	0.987	0.941
2. 40° Tilt-S	Sep. 4-22	N	17/1301	17/1334	16/1254
		C*	10.496	9.884	12.701
		R	0.975	0.986	0.927
3. Shade		Sun			
		Elev.	C	C	C
		60°	10.50	9.84	12.61
		40°	10.455	9.52	12.73
		20°	10.41	9.26	12.965

N= Number of days/Number of 10-minute periods

R= Response, ratio of current calibration to factory calibration

Figures 1-4 are plots of 10-minute average calibration values for August 21, a cloudless day. The calibration values are obtained by ratioing the 10-minute average millivolt values for the test and reference instruments and multiplying the ratio by the calibration value for the reference pyranometer. In addition to plots for the three IEA pyranometers, plots are included for three of the SRF control pyranometers and a Schenk (identified on the plot as Kahl 1292) pyranometer. On all of the plots, some 10-minute values have been deleted before 0700 and after 1700 because of differential shading of the test and reference instrument either during cleaning (in the morning) or by building obstructions (both morning and evening). The SRF control pyranometers are a group of 4 or more Eppley PSP and Spectrolab instruments which are kept in the array for long periods of time and used to keep track of the reference instrument. The plots of EP19129 and Kipp 774120 indicate that either the instruments were not levelled properly on the bench or (more likely) that the spirit level on the instrument did not coincide with the optical level of the instrument's sensing surface. This lack of levelness does not seriously

affect the accuracy of the calibrations determined by the regression method although it does distort the statistics on the quality of the comparison of the test with the reference instrument. The lack of levelness will affect the accuracy of shade calibrations and other comparisons which use only portions of days rather than the entire day. Dashed horizontal lines on the plots are $\pm 1\%$ limits based on the regression calibration value C^* . C' , also shown on the plots is the ratio calibration value; its use would give identical daily radiation totals for both the test and reference instrument. The values for C^* and C' are given in the lower right corner of the diagram.

Figures 5 and 6 give plots for another cloudless day, September 14, when the instruments were operated at a 40° tilt south facing. For these comparisons Eppley PSP 14889 was used as the reference. At horizontal exposure, EP14889 agrees within $\pm 0.5\%$ with the primary reference pyranometer EP14860. In figure 5 EP19129 shows less of the apparent levelling error whereas EP14806 now shows a large levelling error. Subsequent testing of EP14806 confirmed this problem and left little doubt that it is due to a lack of coincidence between the spirit and optical levels. Figure 6 contains a plot for a silicon cell pyranometer, Lambda (now LiCor) 1008, and its response as a function of time of day is not much different than for the Kipp pyranometer.

Figures 7-9 are plots of the shade calibrations with the derived calibration value plotted as a function of the solar elevation angle. In a blocked area within each plot, the data are replotted as cosine curves, normalized to 60° solar elevation. Comparing these plots and the data given in table I, it is apparent that the calibration value for the SRF primary reference transferred to EP19129 and EP14806 through direct comparisons at horizontal gives calibration values for the test instruments which apply to sun elevation angles higher than 60° . This confirms the shade calibration values obtained for the primary reference pyranometer 14860 and several other SRF pyranometers during the summer of 1980. That is, the current calibration level of the SRF is strictly applicable to sun elevations near 70° . The shade calibration of the Kipp774120 is less amenable to analysis. Its indicated decrease in sensitivity with increasing sun elevation is in agreement with the Table I values for tests 1 and 2 but the numerical values do not agree.

Figure 10 is a plot of the relative response of the IEA pyranometers at various tilt angles based on the SRF pyranometer EP14889. Also shown on the diagram are curves for the silicon pyranometer (here identified as LiCor 1008) mentioned earlier and for an Eppley star pyranometer (model 8-48) EP15896. The response value is defined as the output of the test instrument divided by the output of the reference instrument.

Figure 11 is a plot of the temperature test performed on the Kipp774120. The data are normalized to $+30^\circ\text{C}$, in common practice with historical NOAA practice. Between $+30^\circ\text{C}$ and $+10^\circ\text{C}$ the temperature coefficient is $-0.0012\%/^\circ\text{C}$; between $+10^\circ\text{C}$ and -30°C it is $-0.00075\%/^\circ\text{C}$.

Ratio Cal as a Function of Time of Day

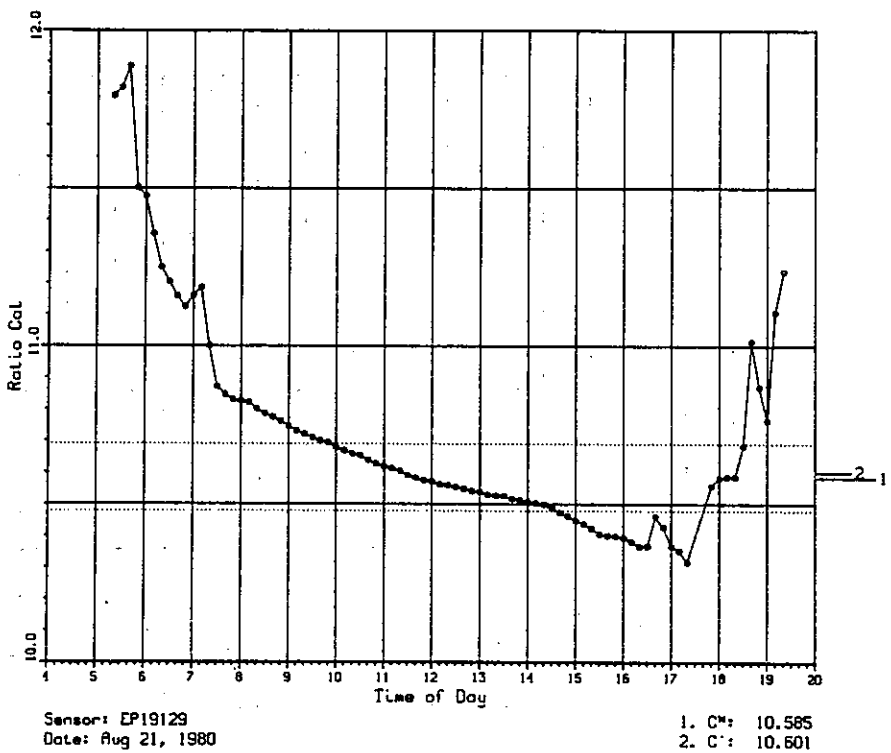
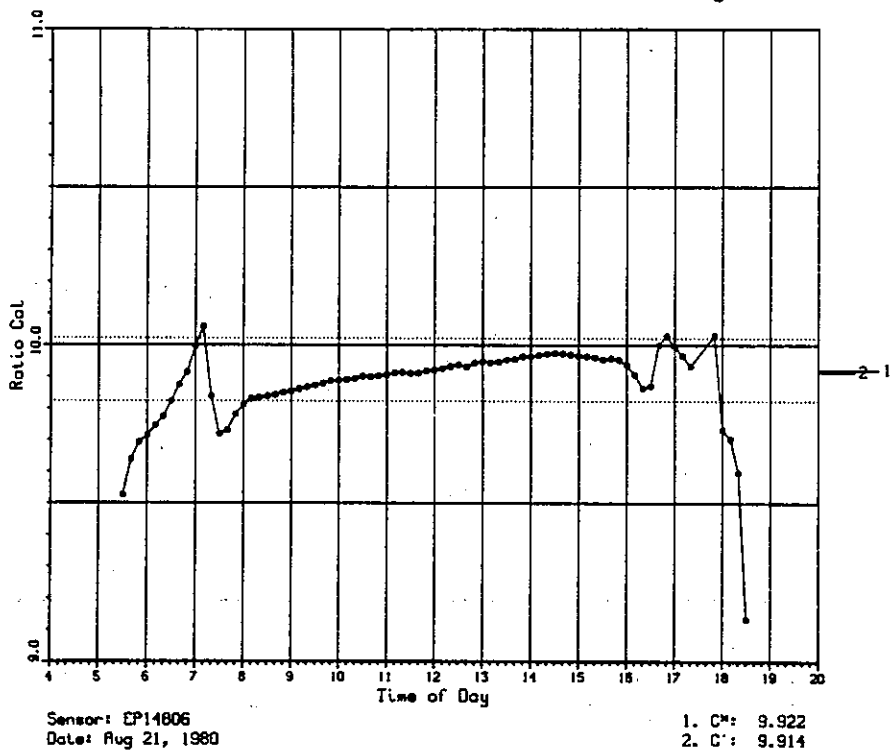

FIGURE 1.

Ratio Cal as a Function of Time of Day

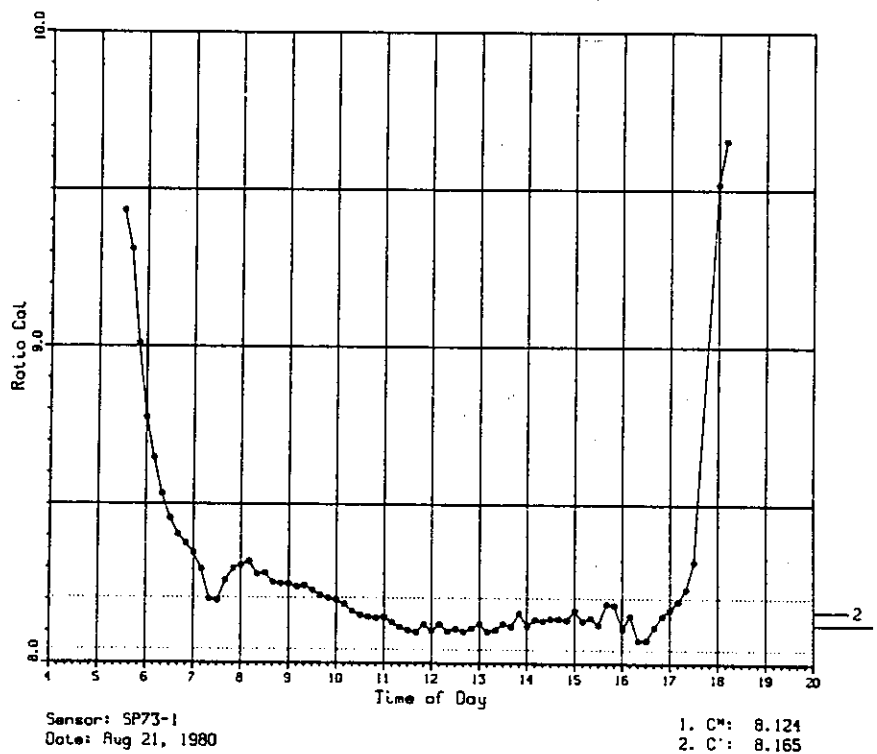
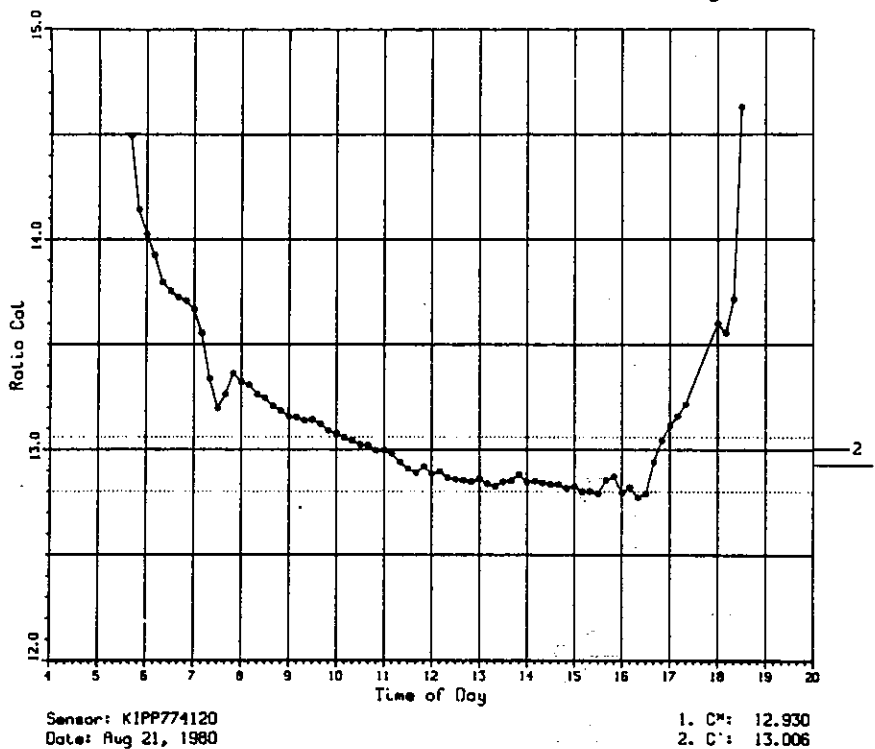

FIGURE 2.

Ratio Cal as a Function of Time of Day

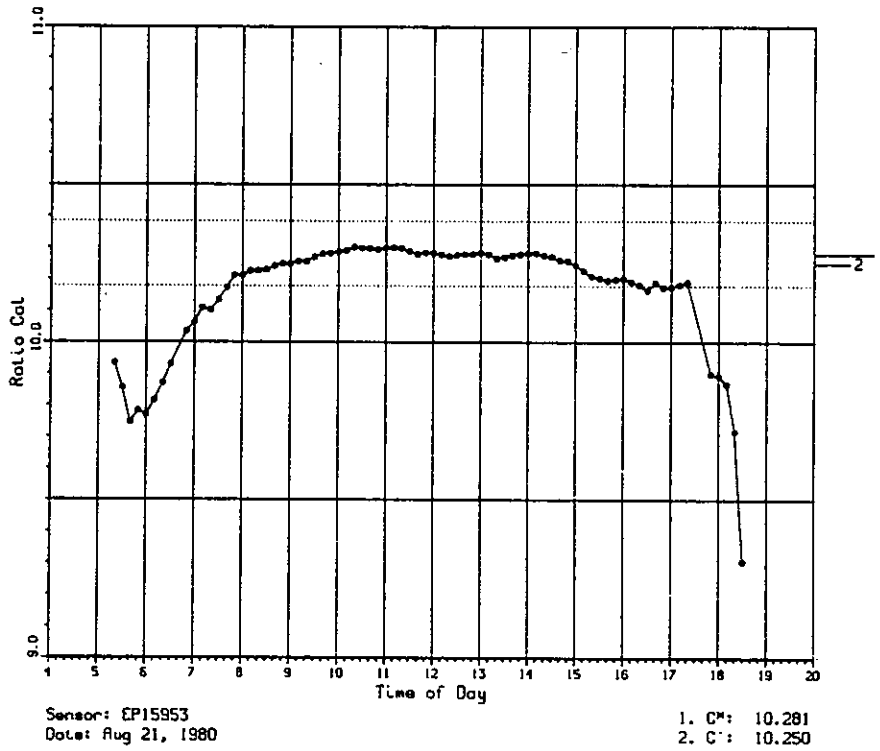
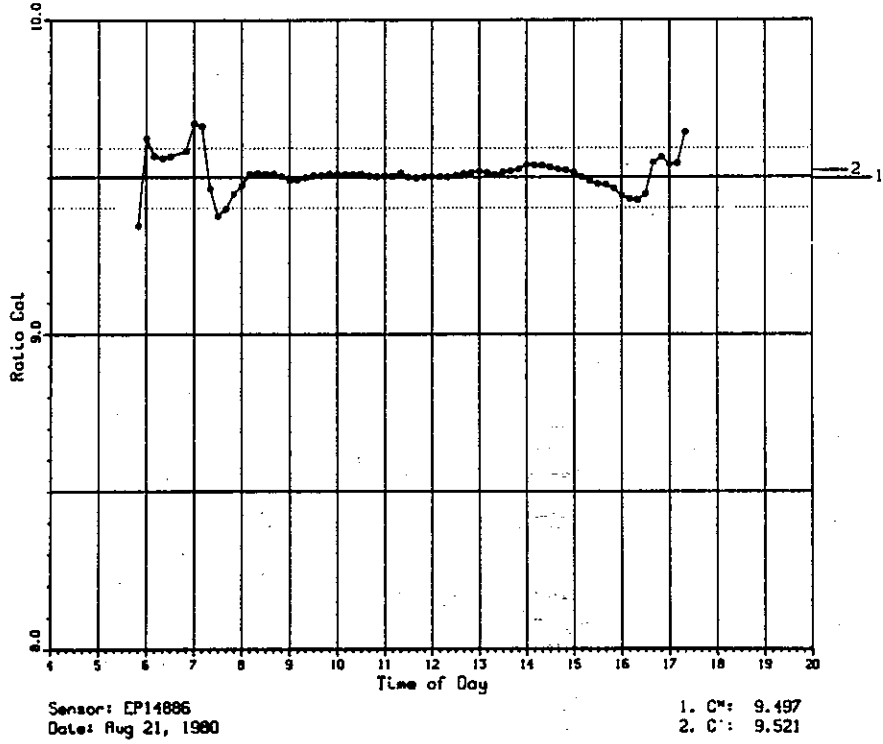

FIGURE 3.

Ratio Cal as a Function of Time of Day

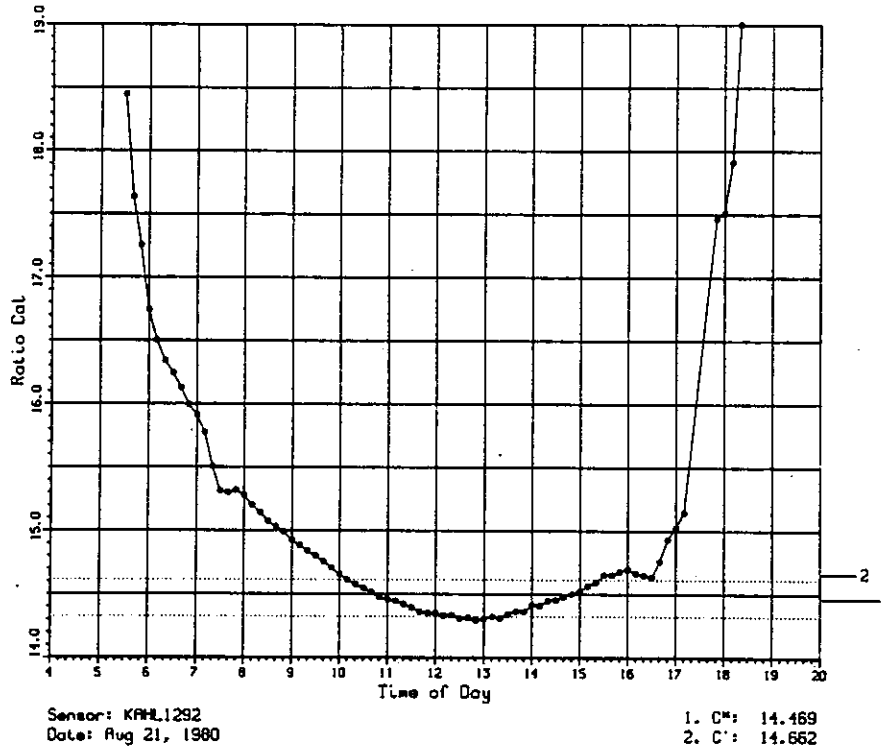

FIGURE 4.

Ratio Cal as a Function of Time of Day

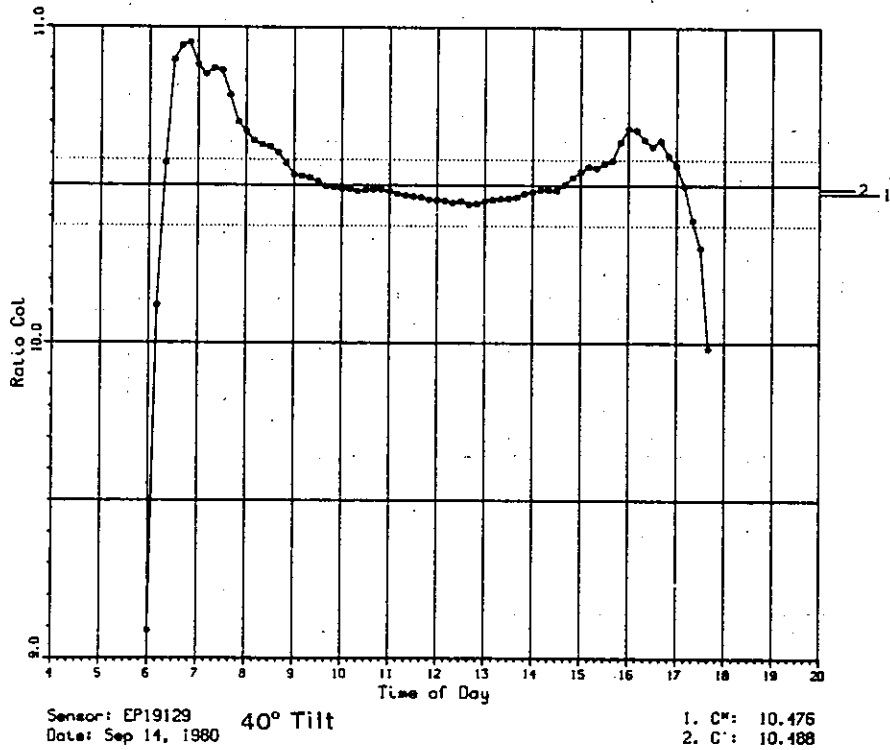
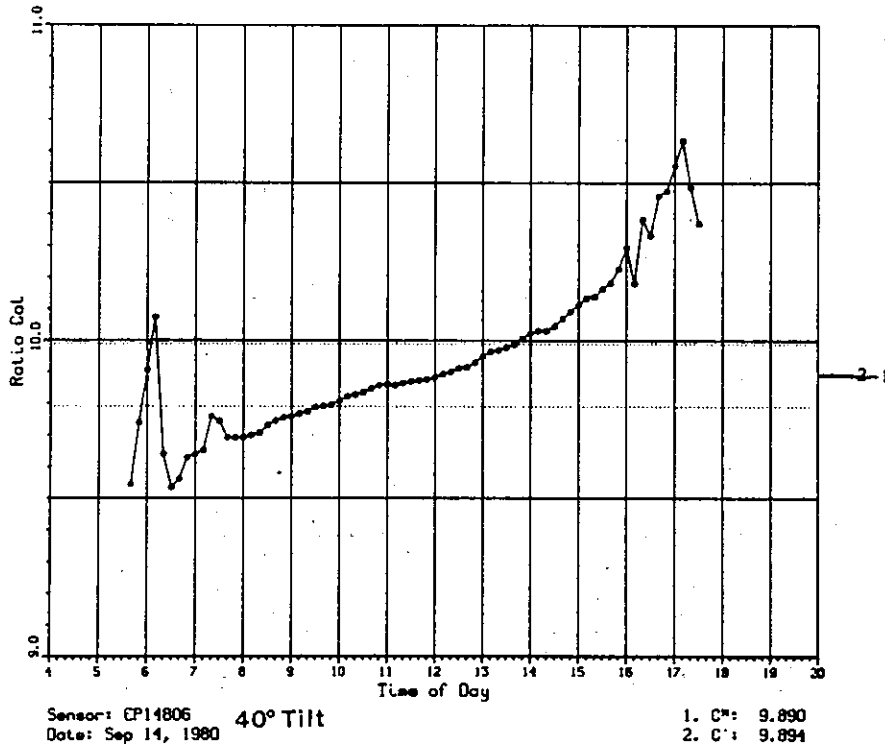

FIGURE 5.

Ratio Cal as a Function of Time of Day

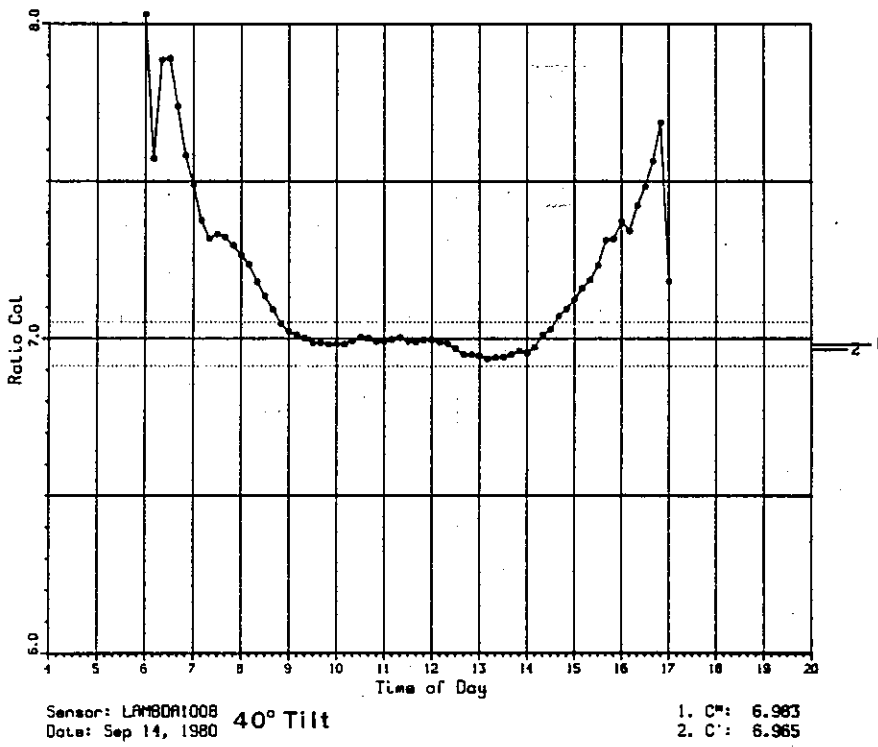
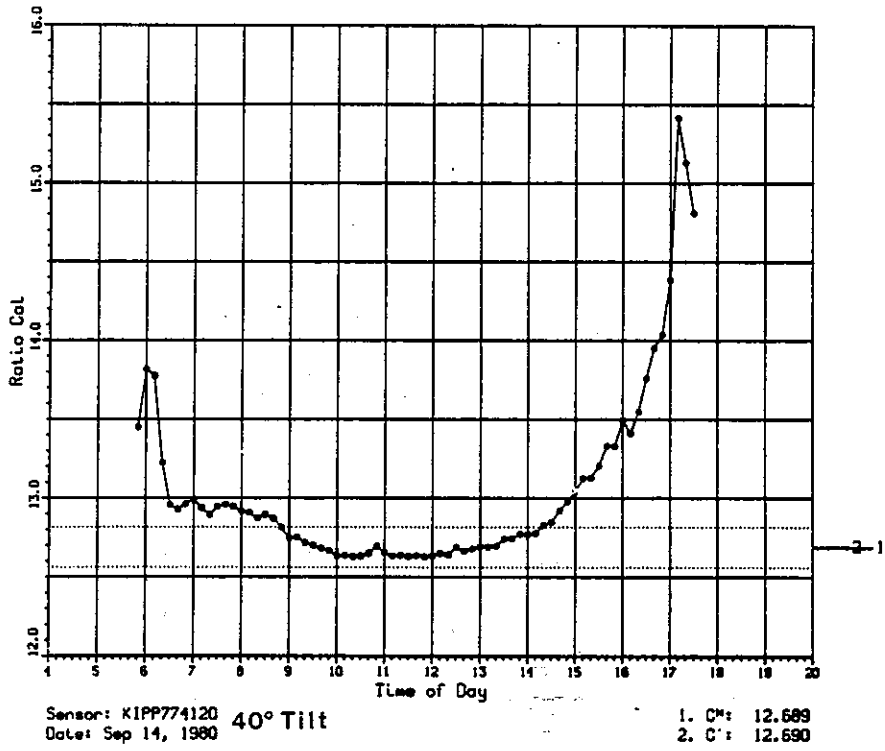

FIGURE 6.

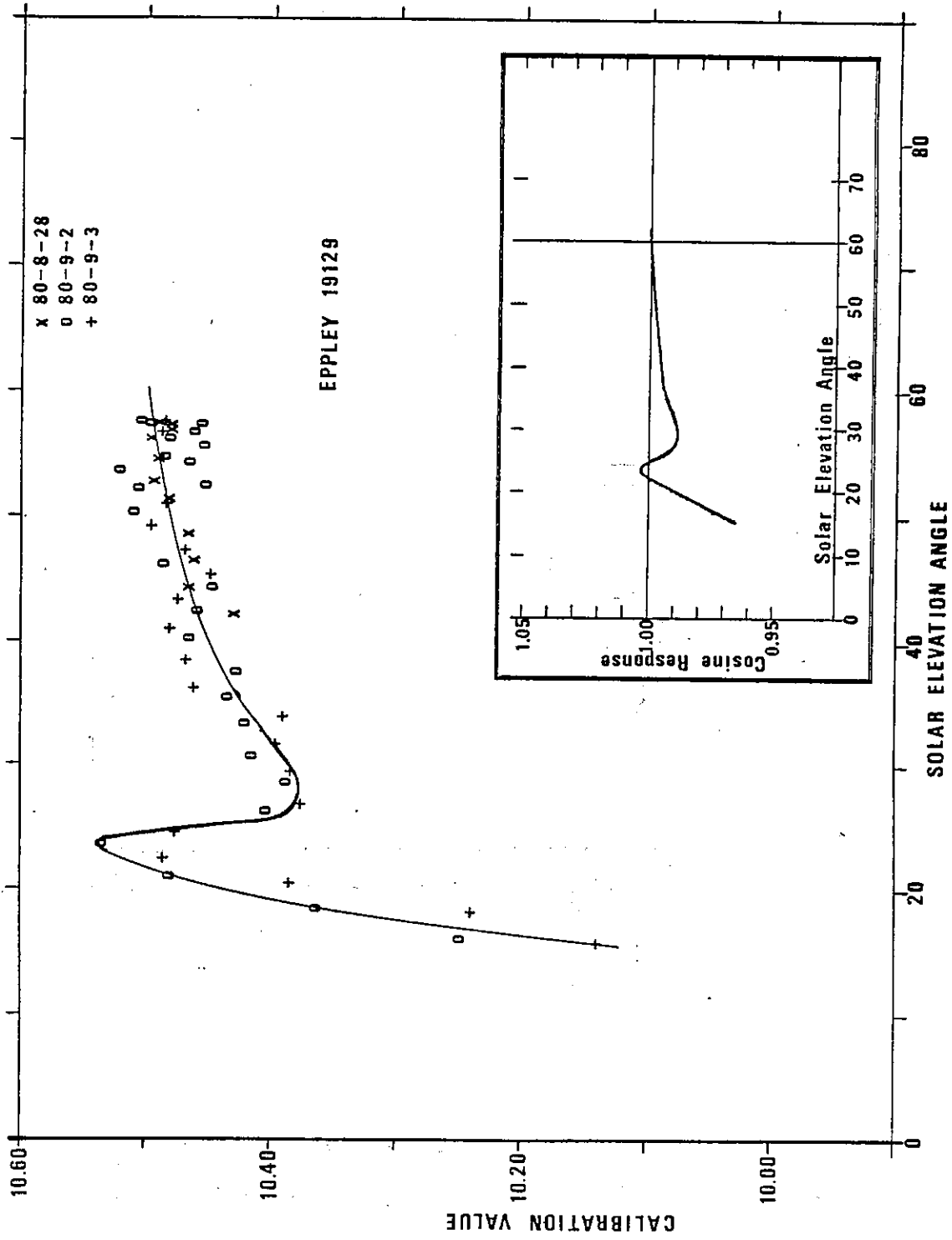

FIGURE 7.

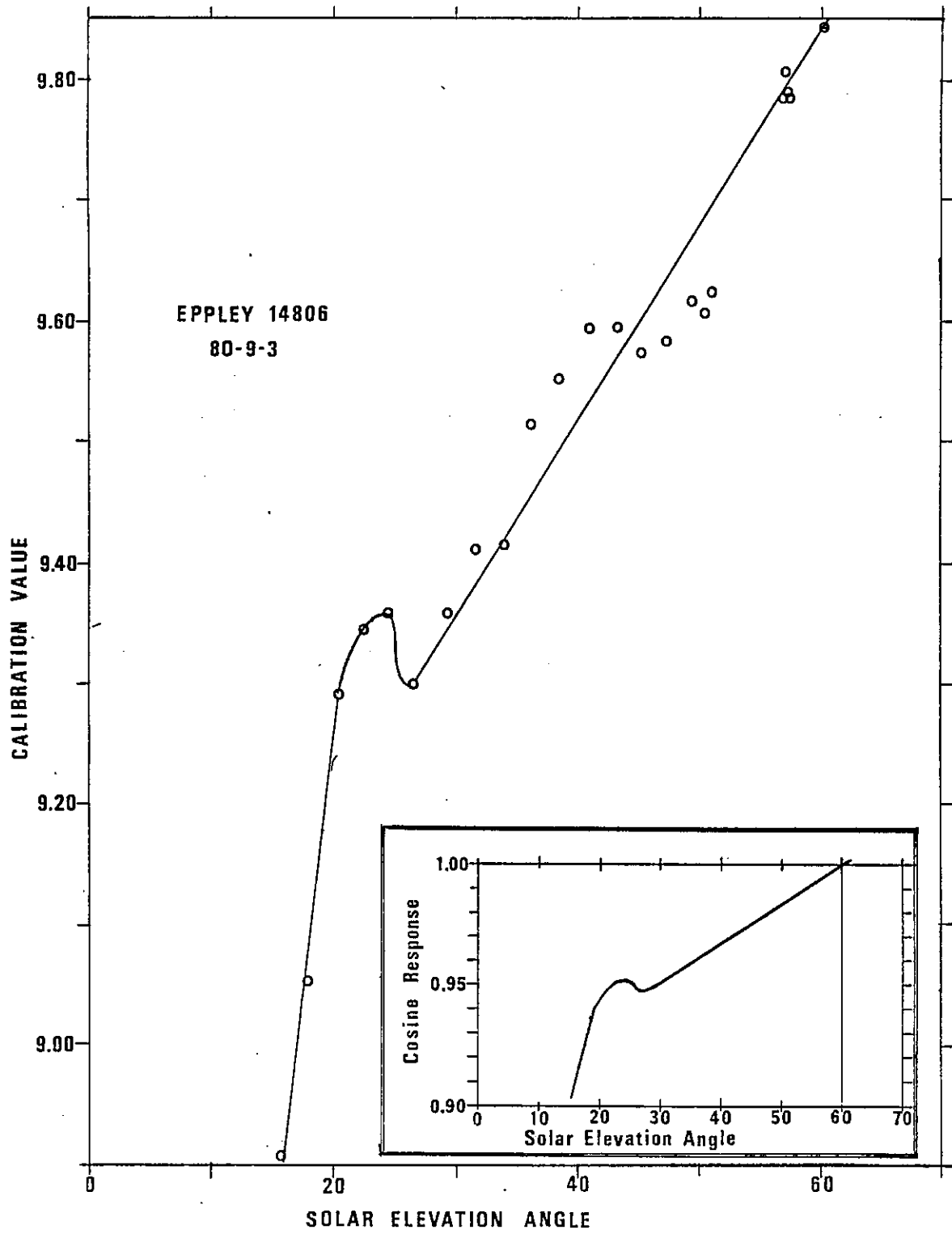

FIGURE 8.

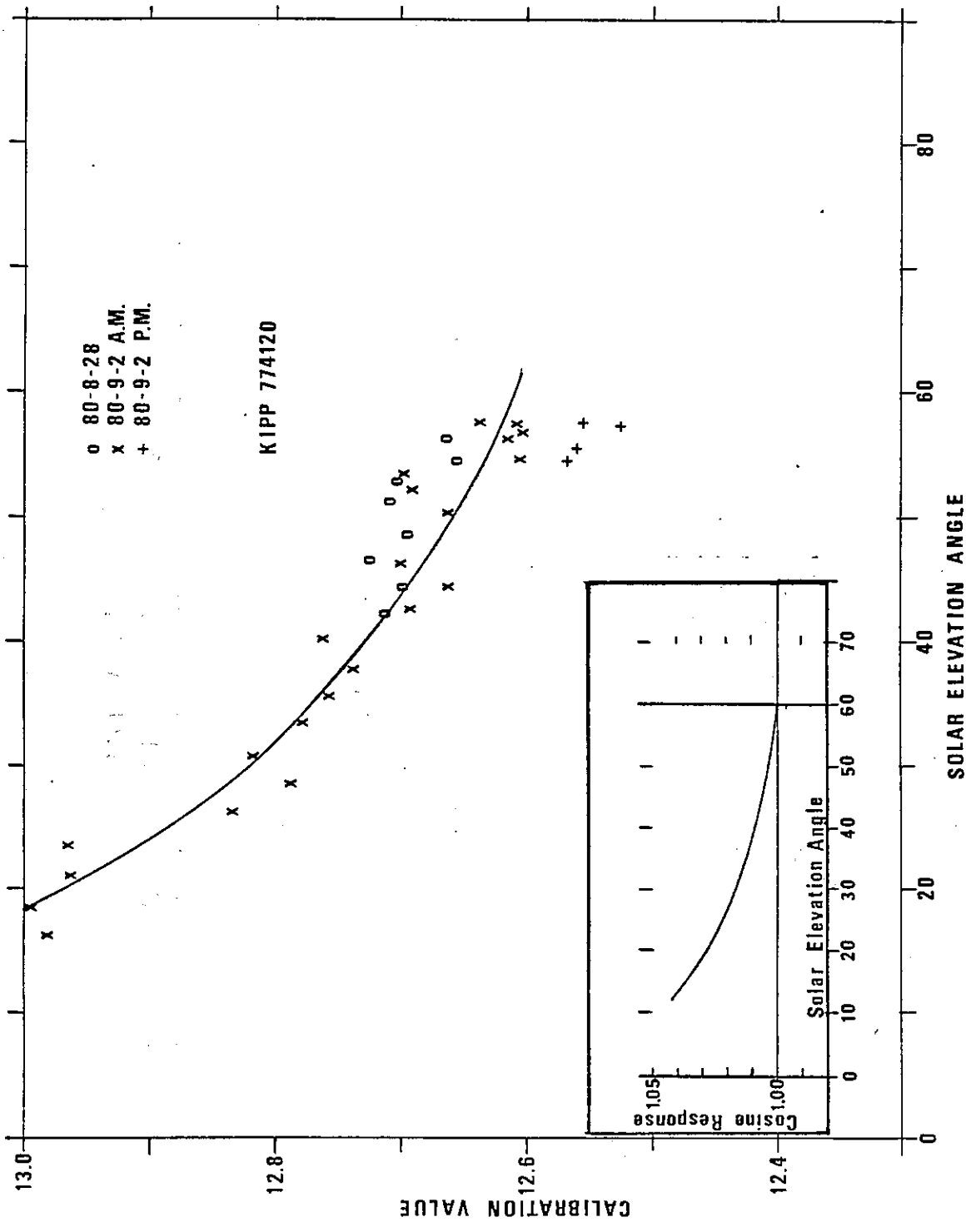

FIGURE 9.

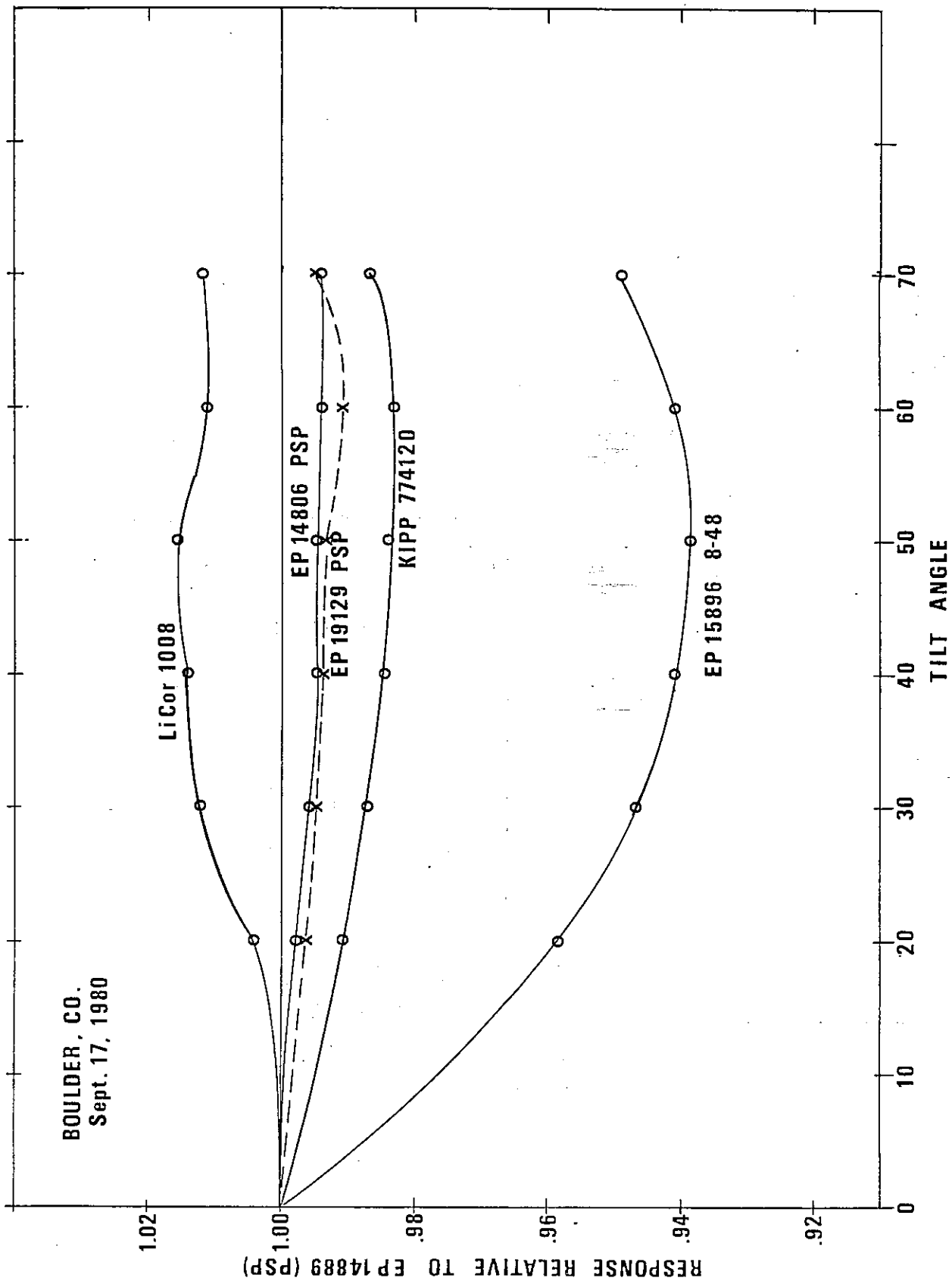

FIGURE 10.

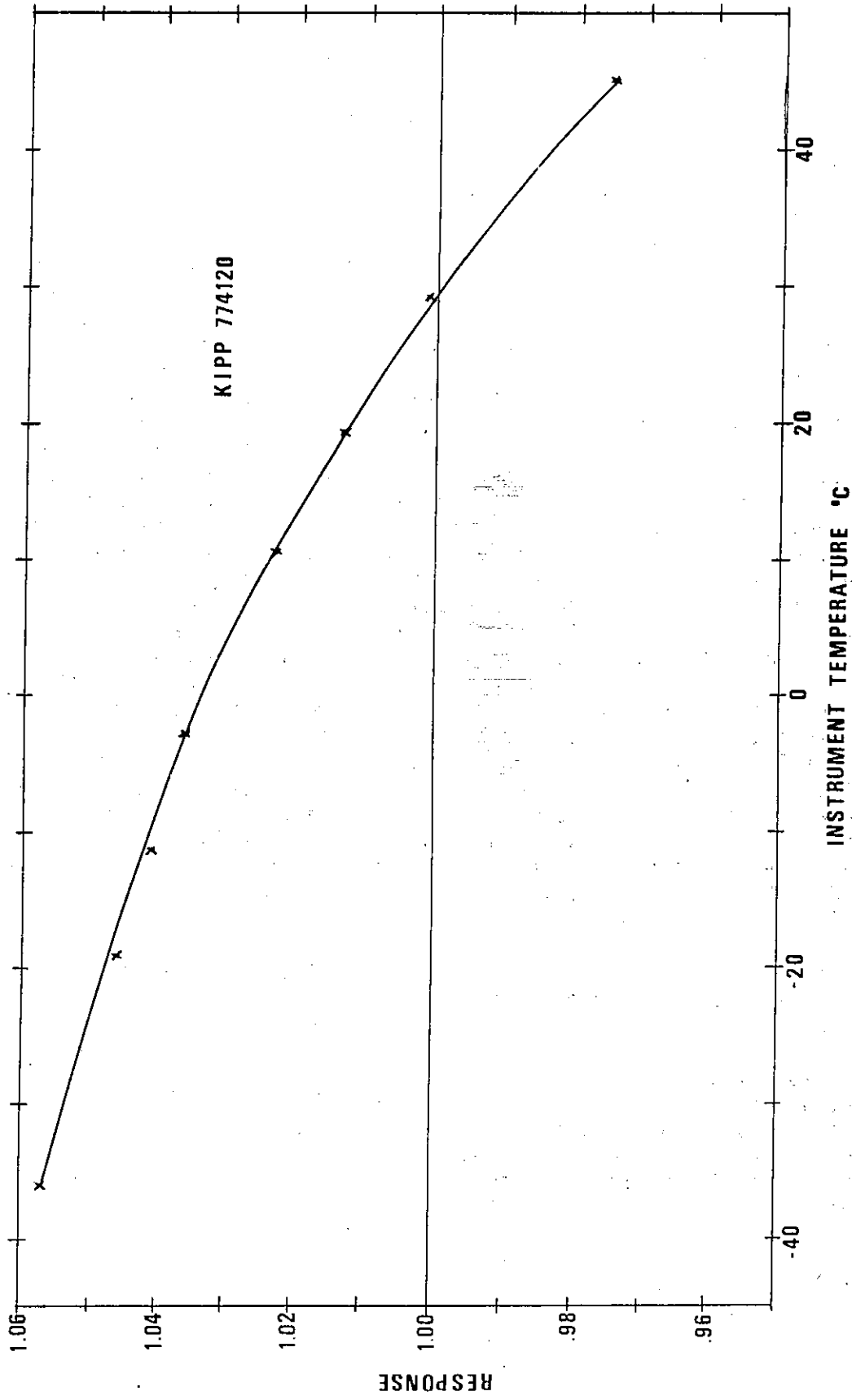

FIGURE 11.

PART II: Description of test methods

Briefly, the tests were done as follows:

1. Calibration on the horizontal by comparison with the SRF reference pyranometer - This calibration is identical with that used for nearly all of the calibrations our Facility does for the NOAA network and all other customers. It involves continuous, side by side, outdoor comparison of the test and reference instrument. Instantaneous outputs in millivolts for all instruments are obtained for each minute. Since the sampling is sequential, the reference output is obtained at regular intervals through the minute and a value for the reference coincident in time with each test instrument sample is obtained by linear interpolation between the successive reference samples. Ten-minute averages of the outputs of the test and reference instruments are formed and used to calculate a linear equation by the method of least squares. The initial calculation uses all of the ten minute values in the daylight period. A second pass of the data is then made in which paired values are discarded where the test value is greater than 1.5 times the standard error determined from the first fit. In this screening, the standard error is used as an absolute value rather than as a percent of the mean. The purpose of this screening is to eliminate in an objective way any outliers in the scatter diagram. The outliers are usually caused by differential shading of the test and reference instrument either by building obstructions or by people working around the instruments. The linear equation: $C^*(\text{test}) = a + b(C\text{-reference})$, where a is the y -intercept and b the slope, is solved for C^* by inserting the calibration value for the reference instrument. Since $C(\text{reference})$ has units $\text{mv}/1000 \text{ watts}\cdot\text{m}^{-2}$, the calibration is effectively at $1000 \text{ watts}/\text{m}^2$. Although regression analyses are performed on each day's data, the final calculation of the calibration value for a test instrument is based on a regression analysis performed on all of the 10-minute values for the entire period of exposure. These are the values given in Table I for both tests 1 and 2. Table II gives daily values from the regression analyses for the IEA instruments, 3 of the SRF control instruments (EP14886, EP15953 and SP 73-1), and an SRF Kipp and Schenk, (Kipp 752683, Schenk 1292). In Table II, 3 days were eliminated from the summary because of appreciable rain during that day or because of persistent low cloudiness (and low irradiance). For the regression performed on the entire period of record, these days with low clouds are included. The calibration values given in the summary for Table II are mostly within 0.1% of the values in Table I test 1.

2. Calibration at 40° tilt, south facing - These calibrations were performed in exactly the same manner as test 1 with the exception that a different reference instrument (EP14889) was used.

3. Calibration on the horizontal by the shade method - This is the traditional method of transferring calibration from a pyrhelimeter to a pyranometer. It involves shading the direct solar radiation from the pyranometer so that the difference between the unshaded and shaded pyranometer output is equal to the vertical component of the direct radiation. Care must be taken that the shading device subtends about the same solid angle as the view angle of the pyrhelimeter. In our tests, the direct irradiance is measured with our cavity radiometer (TMI 67502). The method uses 5 minutes of shade and 6 minutes without shade and all instruments are sampled each 30 seconds. Only the last shade value is used in the analysis. A second pyranometer which is not shaded is also part of the test and the test pyranometer is continuously ratioed to the second pyranometer for the purpose of determining equilibrium conditions and for calculating what the test pyranometer unshaded value would be at the instant of the final shade sample. The derived calibration values for the test instrument are plotted as a function of the sun's elevation in

order to obtain a measure of the instrument's cosine response.

4. Relative response at various tilt angles - These tests were carried out on cloudless days in the period ± 2 hours of solar noon. The test procedure consisted of 5 minutes exposure at horizontal, 5 minutes at tilt, 5 minutes at horizontal, 5 minutes at the next tilt, etc. Two runs through each of the tilt angles is usually made providing the skies remain cloudless. Readings of the voltage outputs of each instrument are made each 30 seconds but only the last 2-1/2 minutes of data at each position are used in the analysis. The relative response for each test instrument at each tilt angle was determined by the measured change from horizontal to tilt for the reference instrument EP14889. Tests were run on 3 different days but only the data for September 17 are presented here. It was by far the best day in terms of clouds although the results are essentially the same for all days. Since the tests were limited to ± 2 hours of solar noon, the effects of different cosine responses between instruments is minimized. The number of runs at each tilt angle, the sun's elevation angle and the sun's angle of incidence at the sensor surface (sum of the elevation angle and tilt angle) are given below:

TILT	NR	SOLAR	
		ELEV.	INCID.
20°	3	50.3	70.3
30°	3	50.4	80.4
40°	5	48.7	88.7
50°	3	50.2	100.2
60°	3	49.9	109.9
70°	3	49.5	119.5

The angles given above are averages for each tilt angle and for the incidence angle it is measured from south to north, i.e., 109.9° incidence means the sun was 19.9° north of normal incidence.

TABLE II
 DAILY CALIBRATION VALUES DETERMINED BY THE REGRESSION METHOD
 HORIZONTAL EXPOSURE
 REFERENCE: EPPLEY PSP, S.N. 14806F3, $C=8.798 \times 10^{-6} \text{ V/w-m}^{-2}$

DATE 1980 AUG.	EP 14806	EP 19129	KIPP 774120	EP 14886	EP 15953	SP 73-1	KIPP 752683	SCHENK 1292	TEMP (°C)	IRRAD ₂ W-Hr/m ²
15	9.96	10.57	12.77	9.48	10.27	8.10	11.91	14.35	21	5580
16	9.87	10.58	12.83	9.46	10.20	8.13	11.89	14.27	23	6600
17	9.89	10.57	12.91	9.51	10.26	8.14	11.98	14.46	24	6360
18	9.89	10.57	12.82	9.52	10.22	8.16	11.87	14.35	27	5877
19	9.89	10.59	12.80	9.51	10.22	8.15	11.85	14.39	27	4758
20	9.91	10.57	12.87	9.50	10.25	8.11	11.94	14.39	22	7374
21	9.92	10.58	12.93	9.50	10.28	8.12	11.96	14.47	22	7085
22	9.90	10.57	12.85	9.50	10.26	8.15	11.90	14.33	27	6674
23	9.91	10.62	12.87	9.49	10.22	8.17	11.88	14.44	27	3706
24	(9.86)	(10.66)	(12.97)	(9.52)	(10.24)	(8.17)	11.96	(14.55)	(24)	(4694)
25	9.98	10.58	12.93	9.52	10.27	8.11	11.93	14.52	22	4309
26	9.94	10.59	12.95	9.52	10.32	8.11	12.01	14.57	18	5366
27	9.84	10.56	12.92	9.53	10.26	8.15	11.95	14.48	23	5832
28	9.86	10.62	12.84	9.43	10.21	8.14	11.87	14.39	27	6195
29	9.88	10.59	12.86	9.46	10.18	8.15	11.90	14.43	26	4630
30	(10.05)	(10.73)	(13.21)	(9.59)	(10.27)	(7.90)	(12.10)	(14.63)	(14)	(1469)
31	(9.75)	(10.64)	(13.04)	(9.39)	(10.26)	(8.15)	(12.05)	(14.61)	(19)	(4850)
SEP. 1	9.88	10.62	12.95	9.45	10.28	8.15	11.99	14.57	19	6727
2	9.87	-	12.88	9.45	10.23	8.12	11.91	14.45	25	5068
SUMMARY										
N	16	15	16	16	16	16	16	16	16	16
C	9.899	10.585	12.873	9.489	10.245	8.134	11.921	14.429	23.7	5821
σ	.0371	.0195	.0536	.0304	.0359	.0196	.0476	.0832	3.0	1040
σ/C	+ .37%	+ .18%	+ .42%	+ .32%	+ .35%	+ .24%	+ .40%	+ .58%		+ .18%
R	0.988	0.984	0.940	0.999	0.997	1.017	1.003	0.981		

R=Response, for I.E.A. instruments the ratio of C to the factory calibration;
 for SRF instruments the ratio of C to the SRF determined calibration.

TABLE III
 DAILY CALIBRATION VALUES DETERMINED BY THE REGRESSION METHOD
 40° TILT-SOUTH FACING
 REFERENCE: EPPLEY PSP, S.N. 14889F3, $C=9.255 \times 10^{-6} \text{ V/w-m}^{-2}$

DATE 1980 SEP.	EP 14806	EP 19129	KIPP 774120	LICOR 1008	TEMP (°C)	IRRAD ₂ W-Hr/m ²
4	9.91	10.51	12.72	6.99	21	6085
5	9.89	10.50	12.69	7.00	26	6110
6	9.90	10.48	12.66	7.02	26	7214
7	9.86	10.50	12.65	7.00	25	5880
8	9.86	10.53	12.72	7.00	22	3384
9	(9.89)	(10.65)	(12.98)	(7.22)	(10)	(839)
10	(9.93)	(10.56)	-	(6.99)	(14)	(2207)
11	9.89	10.49	12.74	6.89	23	7691
12	9.82	10.53	12.68	6.96	20	3979
13	9.88	10.49	12.81	6.99	15	4204
14	9.90	10.49	12.71	6.99	20	7478
15	9.87	10.50	12.66	6.92	26	6140
16	9.91	10.50	12.75	6.91	13	6917
17	9.87	10.49	12.70	6.94	25	7355
18	9.88	10.46	12.65	6.90	26	7579
19	9.87	10.46	12.50	6.92	30	7763
20	9.88	10.49	12.63	6.93	19	7478
21	9.89	10.49	12.70	6.96	21	7402

SUMMARY

N	16	16	16	16	16	16
C	9.880	10.493	12.686	6.958	22.4	6416
σ	.0224	.0188	.0659	.0436	4.3	1423
σ/C	+.23%	+.18%	+.52%	+.63%		+.22%
R	0.986	0.975	0.926	-		

R=Response, the ratio of the C value to the factory calibration.

PART III: Tests on IEA pyranometer, January-March 1981

This section is incomplete since testing has been completed on 9 instruments and is continuing on an additional 12 instruments including 3 pyranometers from EKO Company, Japan, which were not part of the March 1980 Davos comparisons. Table IV summarizes the results of the horizontal exposure calibrations of the first group of instruments.

TABLE IV

PERIOD	JAN 30-FEB 25						FEB 13-25		
INSTR.	EP14806	EP15834	EP17750	EP17823	K774120	K784750	EP16692	K752438	K807177
N	27/1496	27/1519	27/1518	27/1511	27/1484	27/1490	13/739	13/718	13/697
C*	9.909	8.966	9.552	8.991	13.325	11.230	9.716	10.962	10.483
R:EP	0.984	0.997	1.032	1.002	-	-	0.983	-	-
K	-	-	-	-	0.973	0.960	-	0.970	-
SRF	1.001	-	-	-	1.035	-	-	-	-
AES	1.026	1.026	1.034	1.037	1.061	1.039	1.017	1.049	1.035
WRC	1.054	1.062	1.053	1.063	1.062	1.064	1.053	1.050	-

R=Response, ratio of SRF calibration to calibrations of:
 EP= Eppley Labs
 K = Kipp & Zonen
 SRF= NOAA/Solar Radiation Facility
 AES= Atmospheric Environment Service, Canada
 WRC= World Radiation Center, Davos, Switzerland

Table V presents daily calibration values obtained from regression analyses for the IEA instruments. Table VI includes daily values for the same period for a group of SRF control pyranometers and several SRF Kipp and Schenk pyranometers. Daytime average temperatures and total daily radiation values are included in Table VI.

Figures 12-36 are plots of 10-minute calibration values for the IEA and SRF instruments for 3 cloudless days, February 8, 13 and 24, 1981. The levelling problem with EP14806 is evident particularly on Feb. 13 and 24. The spirit levels were specially checked on those two days and did indicate they were level; however, it is obvious that the spirit level is not the optical level for this instrument. Other instruments show various degrees of asymmetry due to this problem.

TABLE V
DAILY CALIBRATION VALUES DETERMINED BY THE REGRESSION METHOD
HORIZONTAL EXPOSURE

REFERENCE: EPPLEY PSP, S.N. 14860F3, $C=8.798 \times 10^{-6} V/w-m^{-2}$

DATE 1981	EPI4806	EPI5834	EPI6692	EPI7750	EPI7823	K752438	K774120	K784750	K807177
JAN 30	9.94	9.03		9.66	9.04		13.57	11.38	
31	9.97	9.01		9.55	9.00		13.38	11.52	
FEB 1	9.94	9.01		9.65	9.01		13.45	11.42	
2	9.90	8.97		9.58	8.99		13.38	11.22	
3	9.88	9.02		9.67	9.08		13.50	11.50	
4	9.92	9.01		9.64	9.05		13.54	11.38	
5	9.91	8.97		9.59	9.02		13.41	11.27	
6	9.91	8.93		9.52	8.94		13.21	12.84	
7	(9.92)	(9.12)		(9.77)	(9.18)		(13.72)	(11.66)	
8	9.88	8.97		9.57	8.99		13.41	11.19	
9	9.96	9.00		9.61	9.03		13.43	11.36	
10	(10.04)	(9.04)		(9.74)	(9.06)		(13.75)	(11.78)	
11	9.98	9.00		9.64	9.00		13.54	11.42	
12	9.93	9.01		9.56	9.01		13.29	11.23	
13	9.90	8.97	9.70	9.51	8.98	10.96	13.26	11.14	10.52
14	9.93	8.95	9.70	9.48	8.93	10.89	13.11	11.08	10.47
15	9.86	8.94	9.71	9.50	8.96	11.00	13.34	11.18	10.49
16	9.92	9.00	9.74	9.53	8.99	11.03	13.36	11.23	10.54
17	9.94	8.94	9.70	9.50	8.94	10.90	13.09	11.01	10.46
18	9.91	9.01	9.75	9.55	9.02	11.01	13.33	11.36	10.51
19	9.86	8.96	9.68	9.48	8.96	10.92	13.20	11.15	10.44
20	9.91	8.97	9.74	9.54	9.02	10.95	13.29	11.20	10.44
21	9.91	8.93	9.74	9.52	8.97	11.05	13.31	11.24	10.57
22	9.92	8.90	9.69	9.51	8.97	11.00	13.28	11.23	10.51
23	9.88	8.97	9.69	9.50	8.94	10.94	13.22	11.31	10.55
24	9.92	8.90	9.68	9.48	8.97	10.90	13.17	11.15	10.42
25	9.92	8.90	9.69	9.47	8.93	10.89	13.14	11.19	10.42

SUMMARY

Jan 30-	N	25	25	25	25	25	25	25		
Feb 25	C*	9.916	8.971	9.556	8.990	13.328	11.265			
	σ	.0303	.0393	.0653	.0394	.1354	.1267			
	σ/C^*	+ .31%	+ .44%	+ .68%	+ .44%	+ 1.02%	+ 1.12%			
	R	0.990	0.998	0.932	0.902	0.973	0.963			
Feb 13-	N	13	13	13	13	13	13	13	13	
25	C*	9.905	8.949	9.707	9.505	8.967	10.955	13.238	11.190	10.488
	σ	.0267	.0358	.0261	.0255	.0301	.0556	.0919	.0906	.0487
	σ/C^*	+ .27%	+ .40%	+ .27%	+ .27%	+ .34%	+ .51%	+ .69%	+ .81%	+ .46%
	R	0.989	0.995	0.982	0.926	0.900	0.969	0.966	0.956	

R=Response, ratio of C* to factory calibration

TABLE VI
 DAILY CALIBRATION VALUES DETERMINED BY THE REGRESSION METHOD
 HORIZONTAL EXPOSURE
 REFERENCE: EPPLEY PSP, S.N. 14860F3, $C=8.798 \times 10^{-6} \text{ V/w-m}^{-2}$

DATE 1981	EP14886	EP15953	SP 73-1	K752683	SCH1292	SCH1676	SCH1681	TEMP (°C)	IRRAD ₂ Whr/m ²
JAN 30	9.57	10.36	8.14	12.51	15.55	14.81	15.99	-3	1966
31	9.50	10.33	8.01	12.39	15.45	14.27	15.96	-3	2438
FEB 1	9.52	10.34	8.06	12.44	15.42	14.46	15.97	-7	2628
2	9.50	10.32	8.08	12.34	15.22	14.37	15.65	-1	3332
3	9.49	10.30	8.10	12.50	15.63	14.56	16.10	0	2031
4	9.52	10.35	8.10	12.45	15.43	14.61	15.96	-4	3156
5	9.50	10.37	8.11	12.34	15.32	14.46	15.79	1	3329
6	9.46	10.26	8.04	12.27	15.11	13.99	15.56	5	2054
7	(9.53)	(10.32)	(8.17)	(12.61)	(15.75)	(15.00)	(16.11)	(-6)	(1622)
8	9.51	10.31	8.11	12.31	15.18	14.34	15.62	3	3715
9	9.53	10.34	8.08	12.34	15.30	14.40	15.84	-6	2457
10	(9.51)	(10.40)	(7.95)	(12.73)	(15.78)	(14.57)	(16.27)	(-21)	(2008)
11	9.54	10.33	7.99	12.43	15.50	14.57	15.98	-12	3028
12	9.44	10.32	8.13	12.24	15.18	14.15	15.80	8	4028
13	9.44	10.25	8.13	12.17	15.02	14.07	15.67	11	4037
14	9.43	10.23	8.13	12.08	14.99	14.05	15.63	15	2961
15	9.45	10.24	8.16	12.23	15.08	14.18	15.62	11	3444
16	9.48	10.26	8.16	12.22	15.18	14.33	15.84	10	3808
17	9.44	10.23	8.07	12.05	14.96	14.11	15.53	12	3105
18	9.44	10.30	8.16	12.23	15.12	14.18	15.70	11	3443
19	9.43	10.22	8.16	12.14	14.99	13.98	15.54	16	2878
20	9.46	10.28	8.19	12.16	15.02	14.11	15.64	12	3396
21	9.44	10.32	8.08	12.30	15.28	14.20	15.74	3	3040
22	9.44	10.28	8.12	12.22	15.03	14.12	15.73	7	4352
23	9.37	10.19	8.06	12.17	15.06	14.02	15.64	11	2621
24	9.50	10.27	8.15	12.12	14.91	13.98	15.70	12	4575
25	9.48	10.25	8.15	12.13	14.92	14.06	15.62	14	4167

SUMMARY:

JAN 30-	N	25	25	25	25	25	25	25	25
FEB 25	C*	9.475	10.290	8.107	12.271	15.194	14.255	15.753	5.0
	σ	.0446	.0486	.0501	.1313	.2085	.2268	.1620	7.8
	σ/C*	+ .47%	+ .47%	+ .62%	+ 1.07%	+ 1.37%	+ 1.59%	+ 1.07%	+ 23%
	R	0.998	1.001	1.014	1.033	1.034			
FEB 13-	N	13	13	13	13	13	13	13	13
25	C*	9.445	10.255	8.132	12.170	15.043	14.108	15.661	11.2
	σ	.0307	.0350	.0395	.0690	.1035	.0983	.0834	3.3
	σ/C*	+ .30%	+ .34%	+ .49%	+ .57%	+ .69%	+ .70%	+ .53%	+ 17%
	R	0.995	0.998	1.017	1.024	1.023			

R=Response, ratio of C* to SRP determined calibration

Ratio Cal as a Function of Time of Day

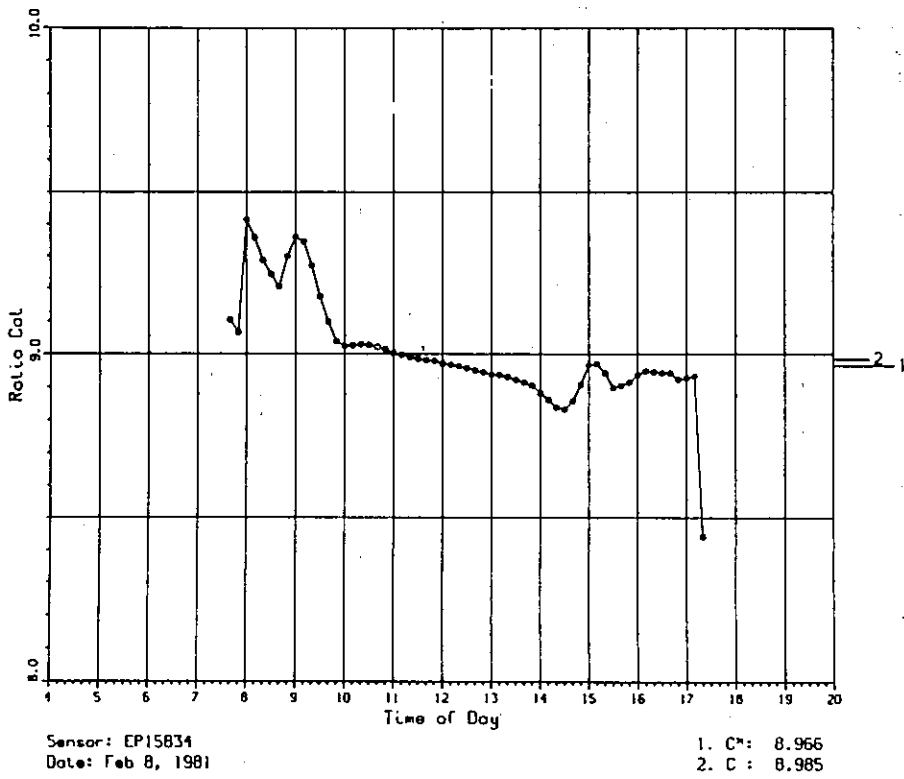
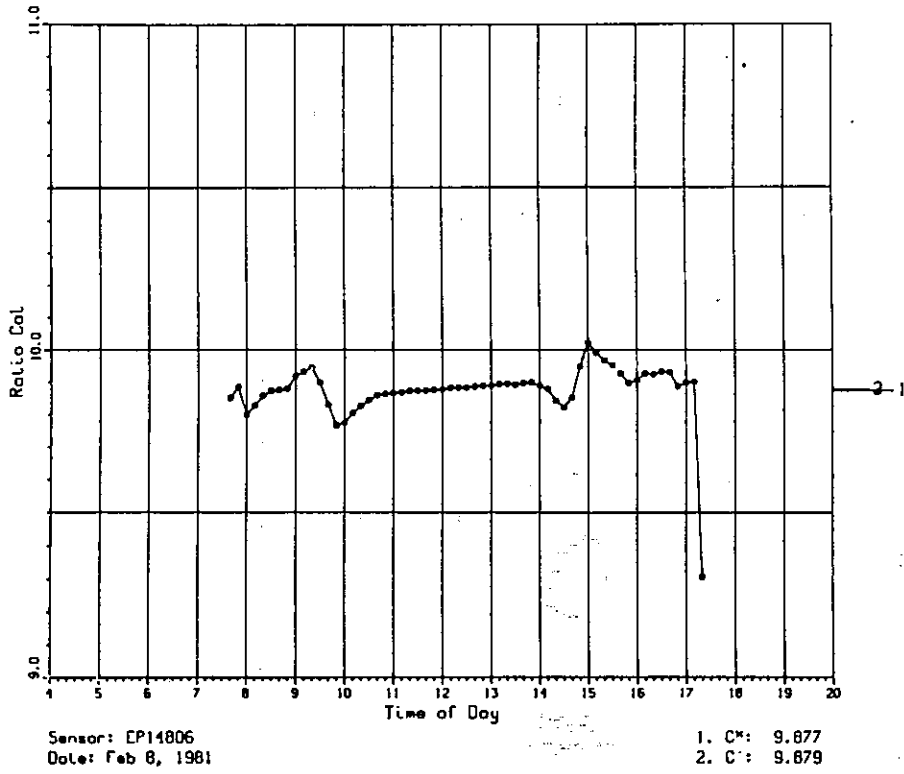

FIGURE 12.

Ratio Cal as a Function of Time of Day

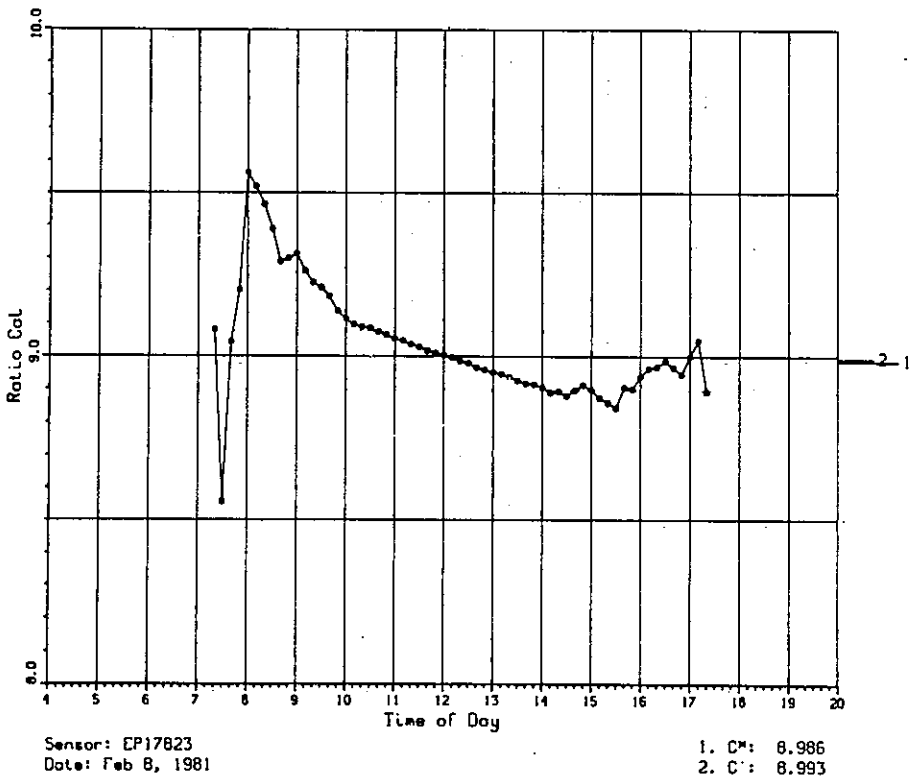
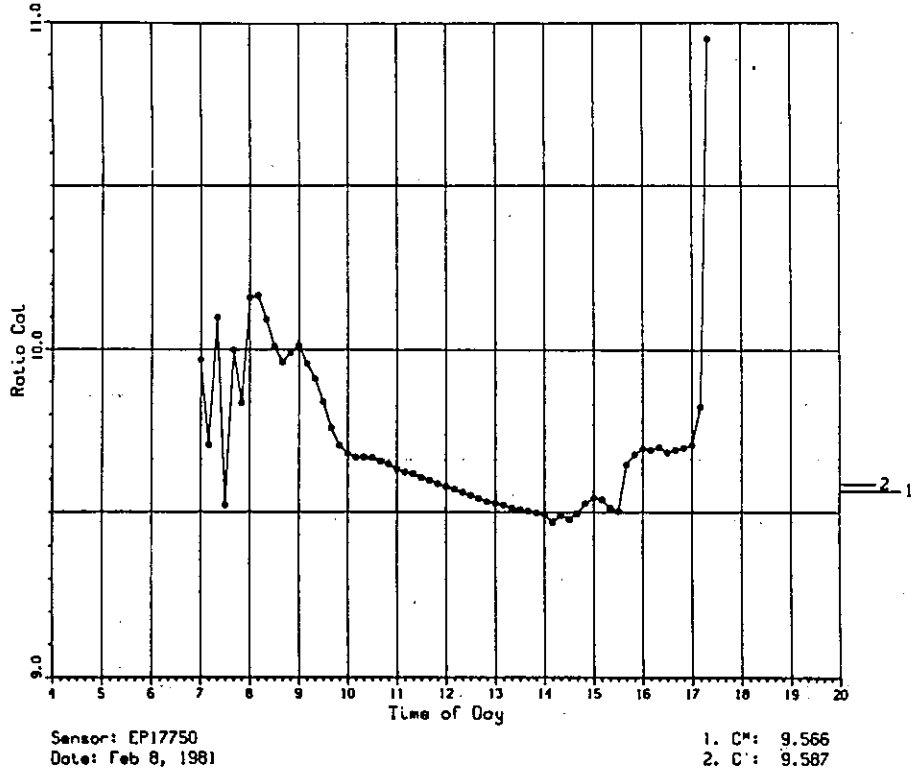

FIGURE 13.

Ratio Cal as a Function of Time of Day

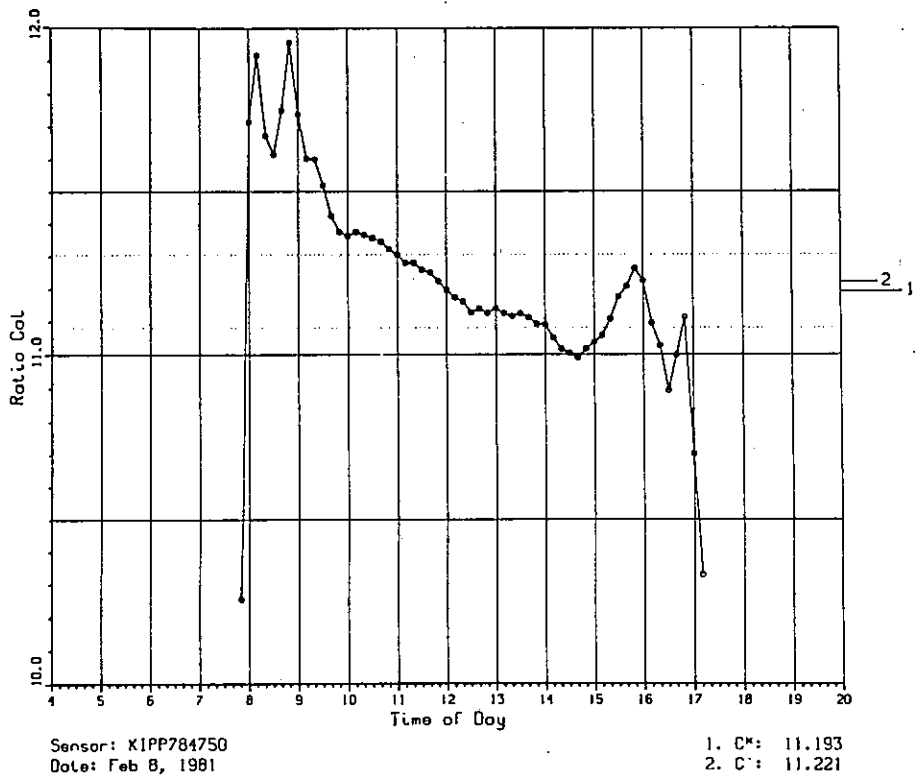
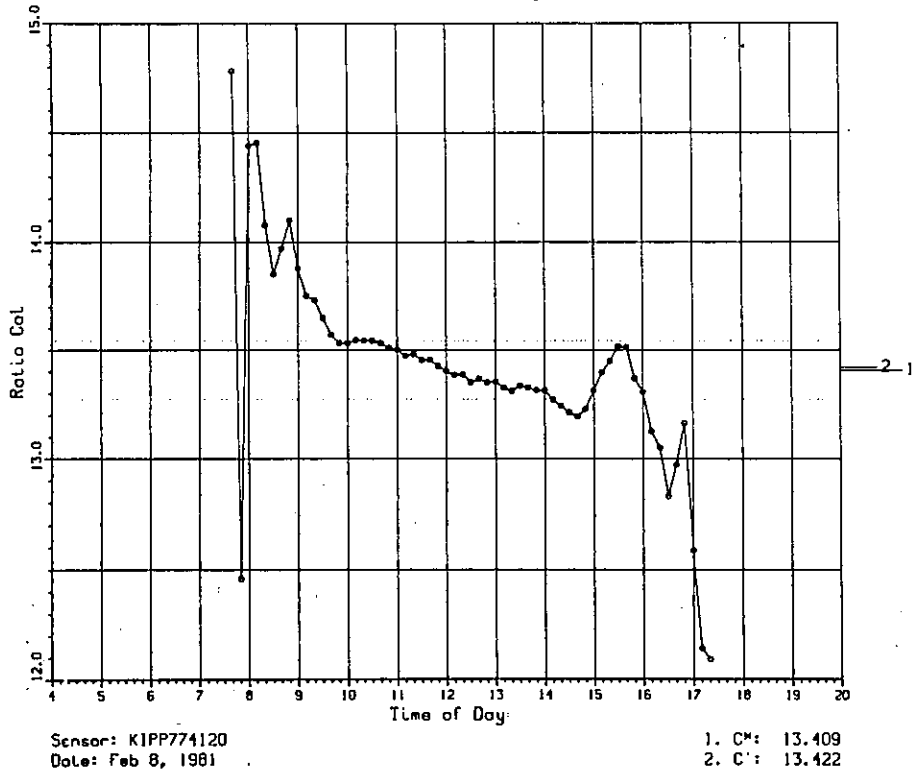

FIGURE 14.

Ratio Cal as a Function of Time of Day

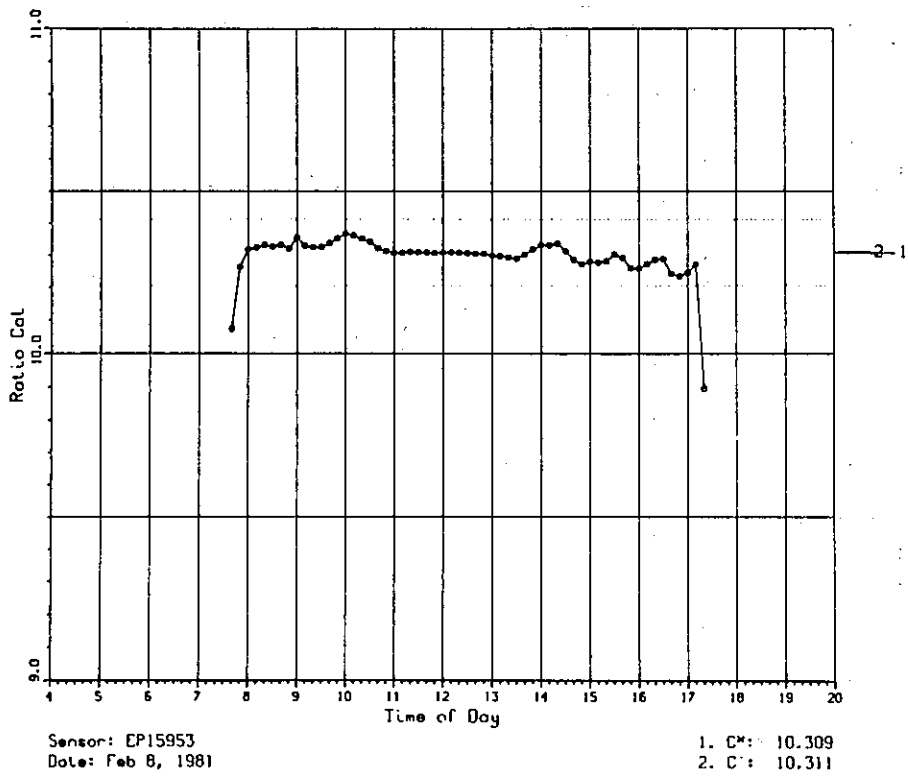
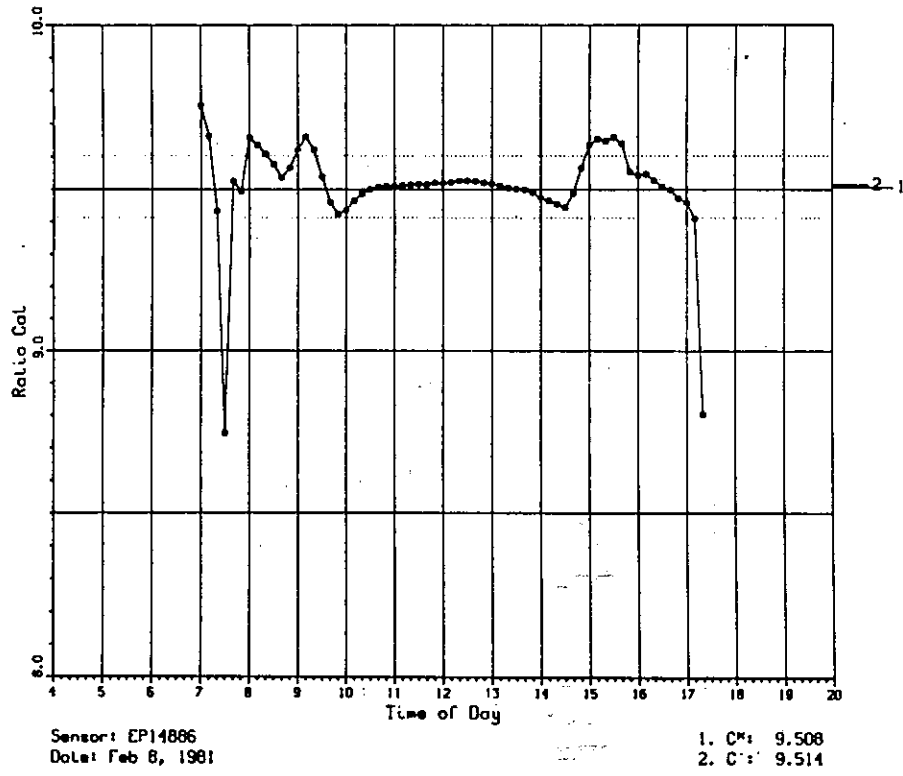

FIGURE 15.

Ratio Cal as a Function of Time of Day

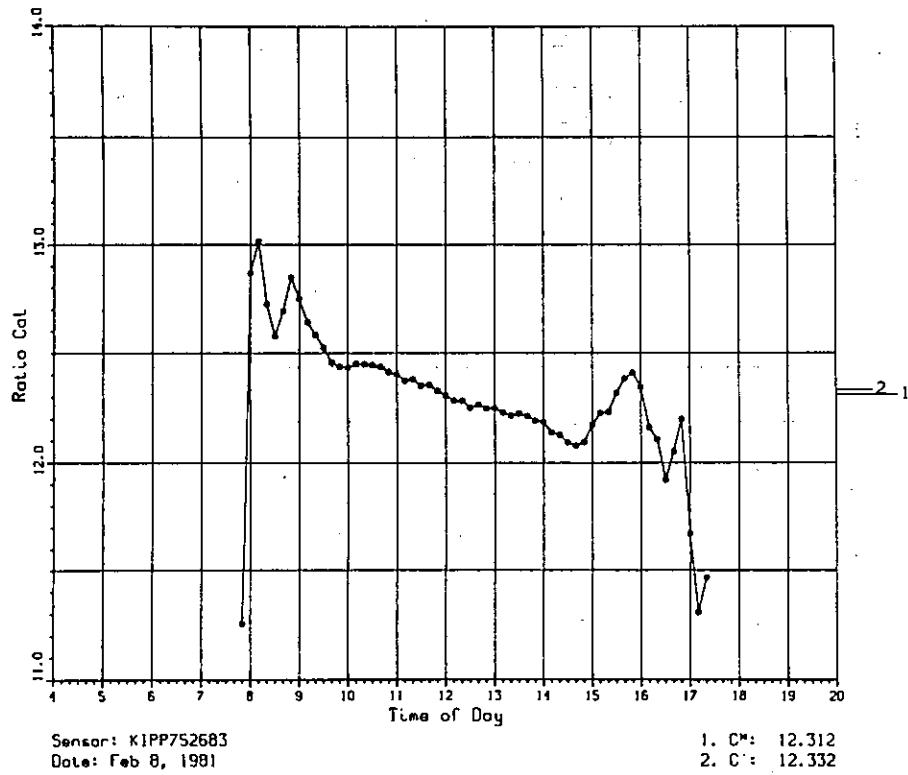
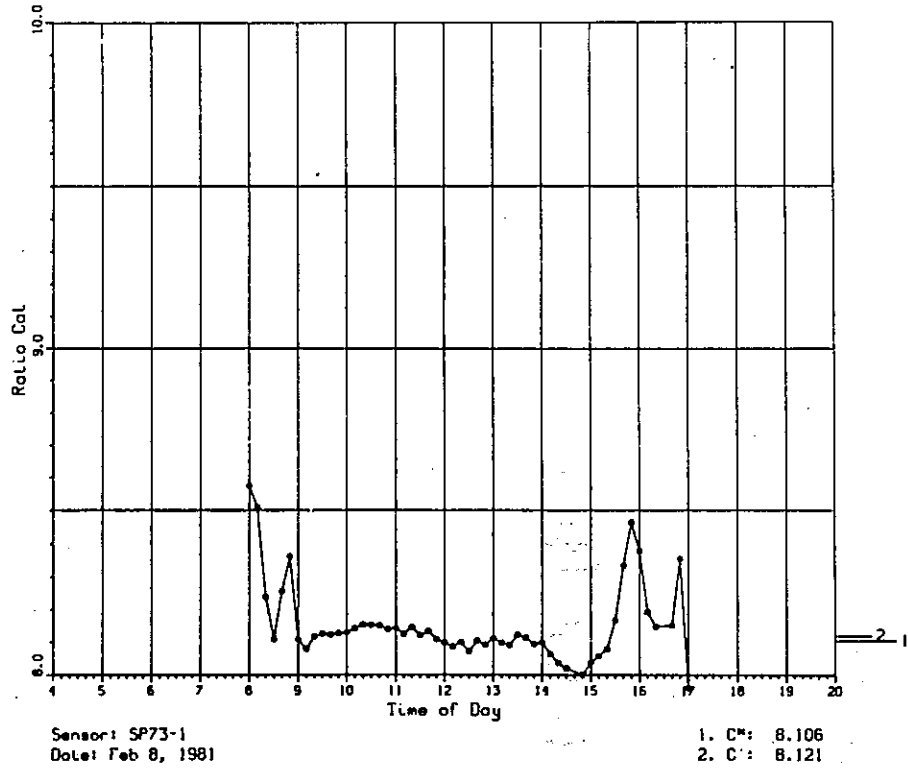

FIGURE 16.

Ratio Cal as a Function of Time of Day

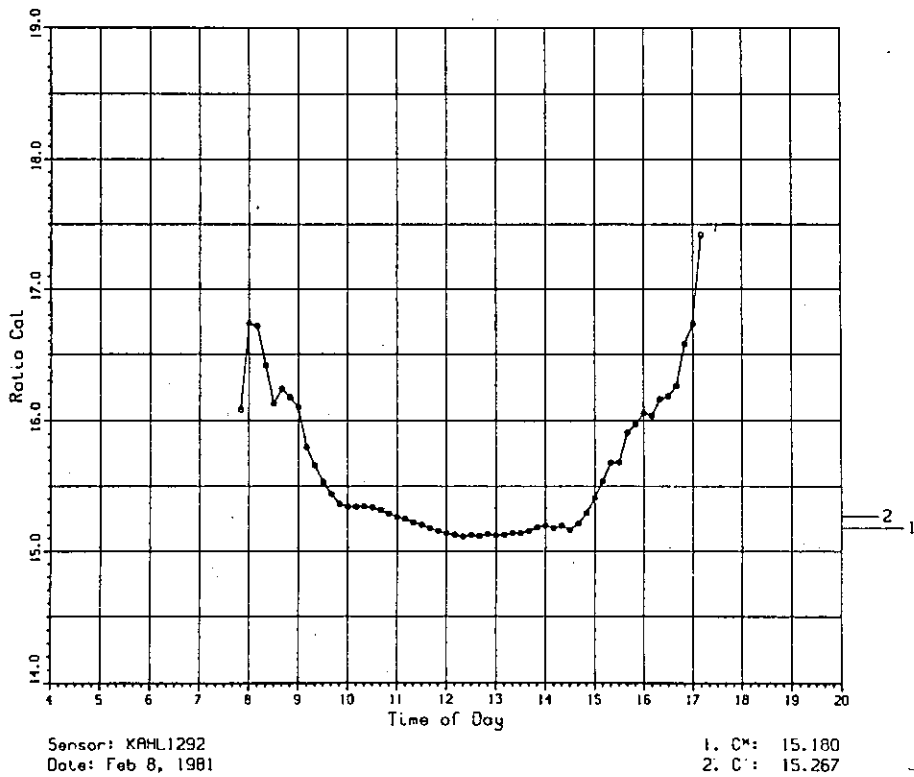
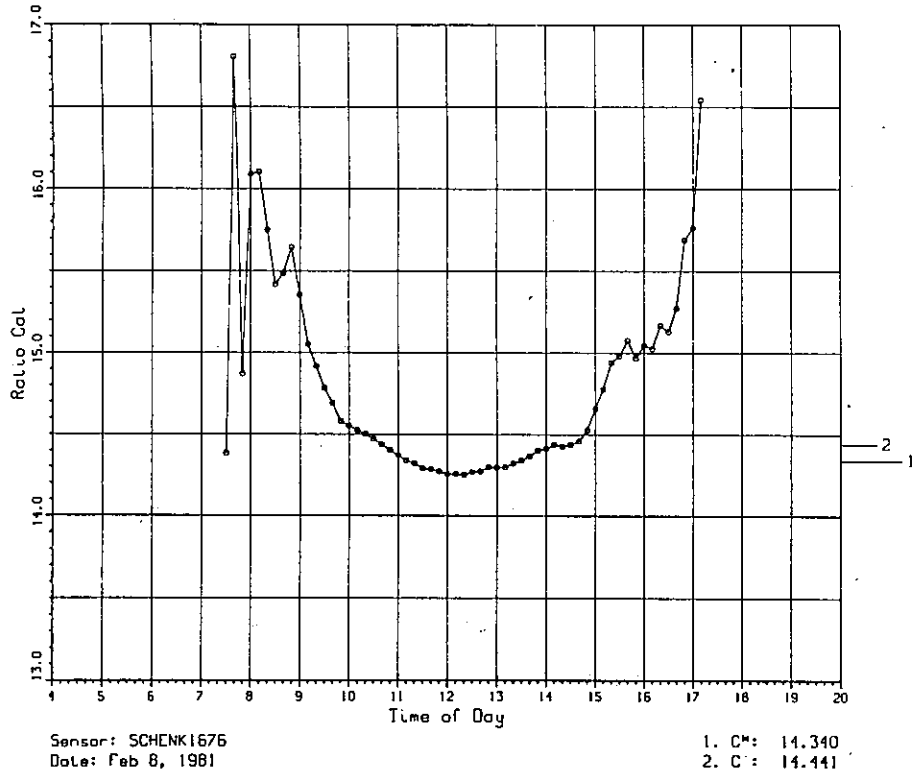

FIGURE 17.

Ratio Cal as a Function of Time of Day

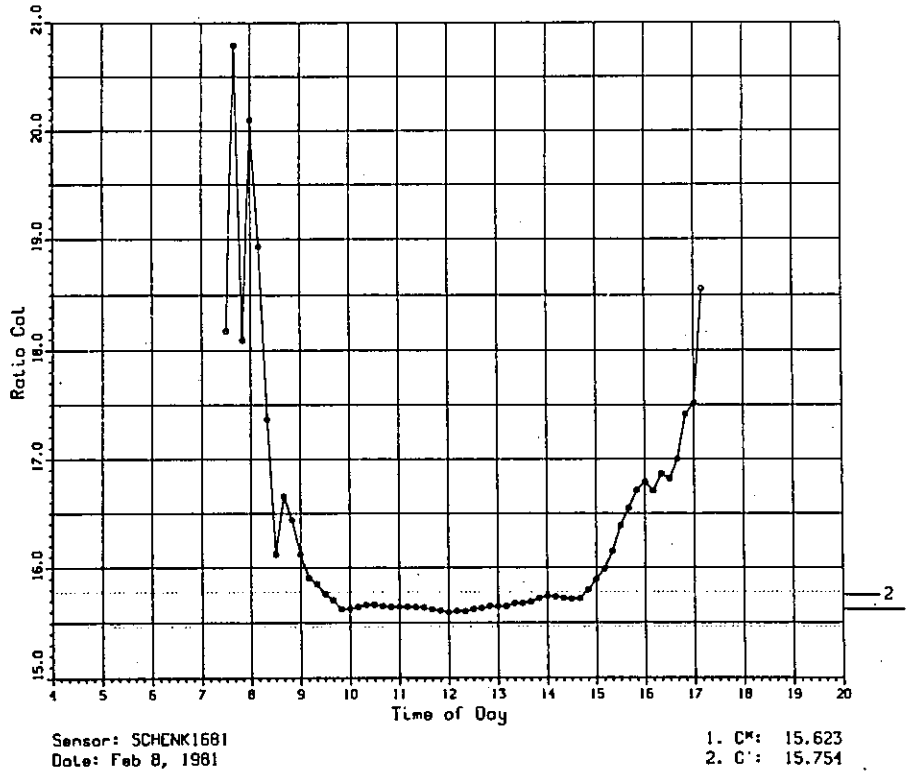

FIGURE 18.

Ratio Cal as a Function of Time of Day

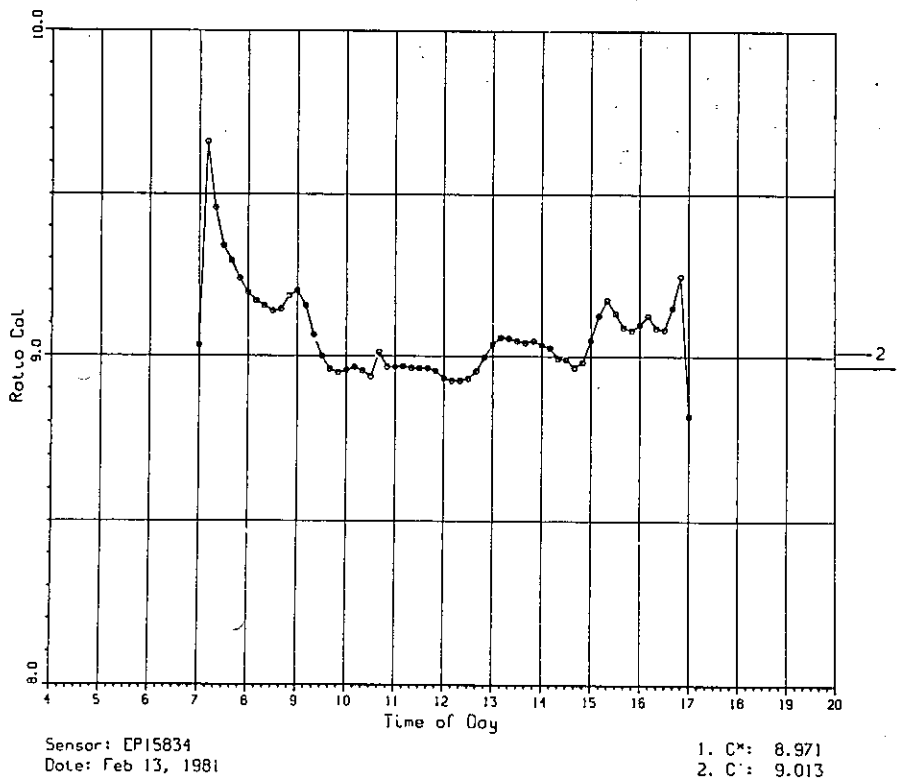
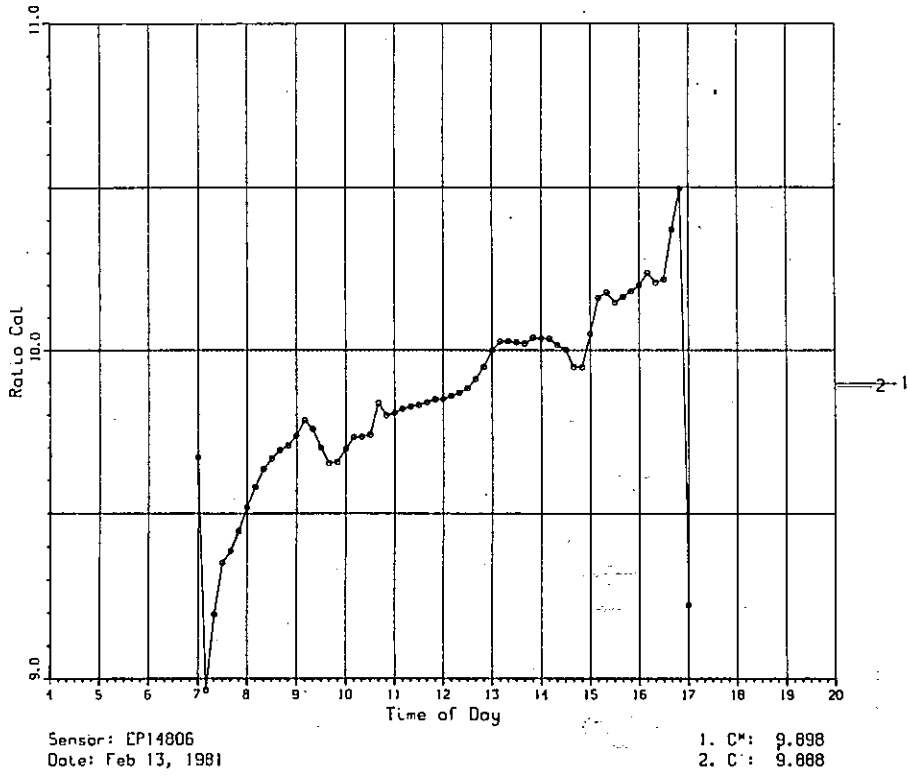
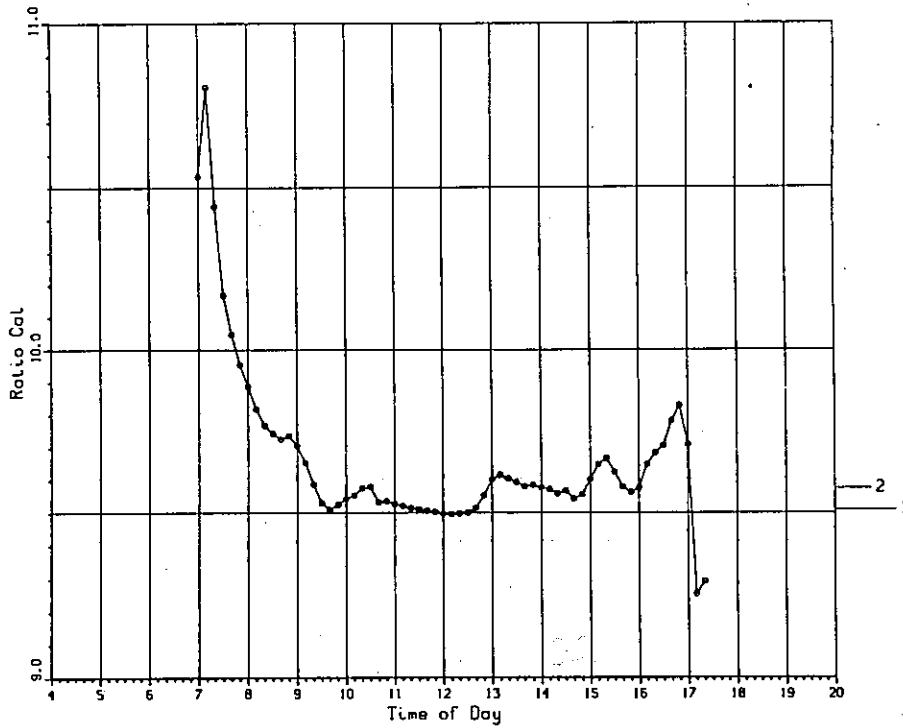

FIGURE 19.

Ratio Col as a Function of Time of Day



Sensor: EP17750
Date: Feb 13, 1981

1. C*: 9.510
2. C*: 9.575

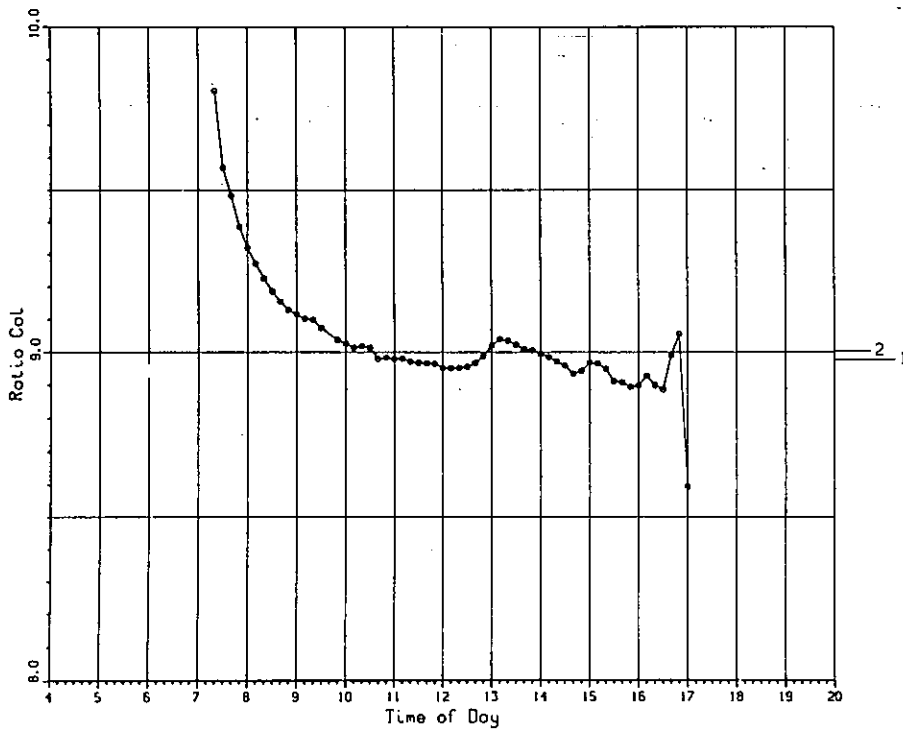

Sensor: EP17823
Date: Feb 13, 1981

1. C*: 8.978
2. C*: 9.004

FIGURE 20.

Ratio Col as a Function of Time of Day

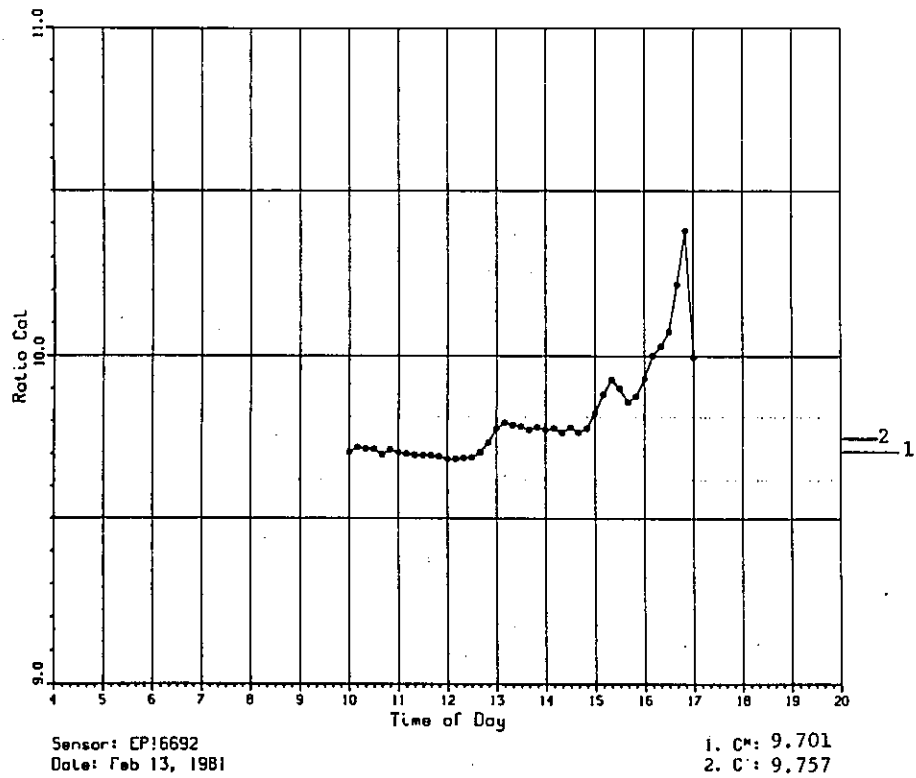
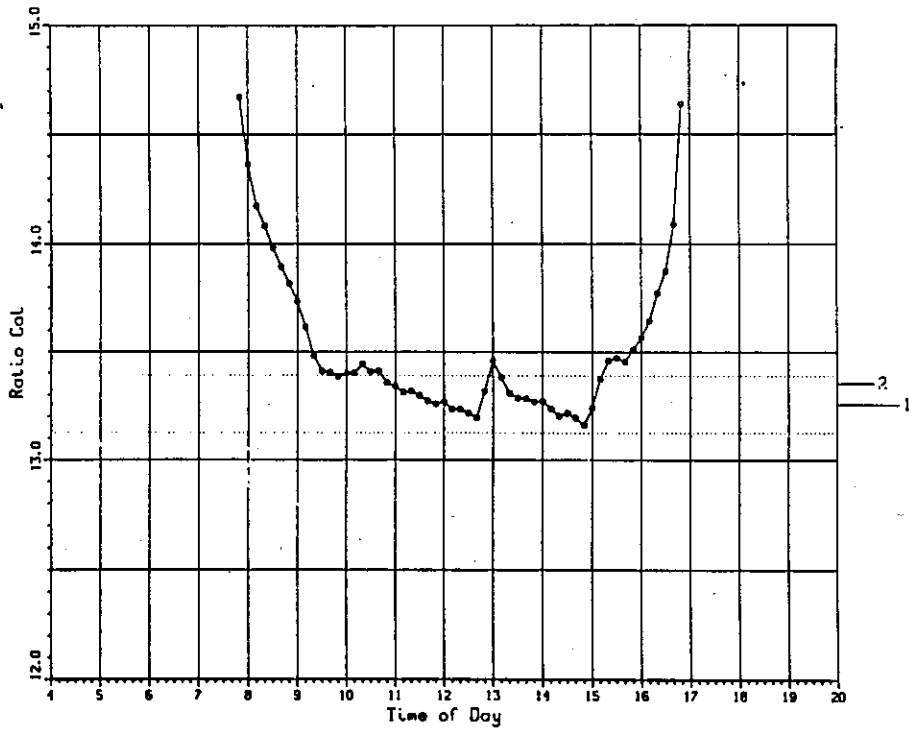

FIGURE 21.

Ratio Col as a Function of Time of Day



Sensor: KIPP774120
Date: Feb 13, 1981

1. C^m: 13.258
2. Cⁱ: 13.355

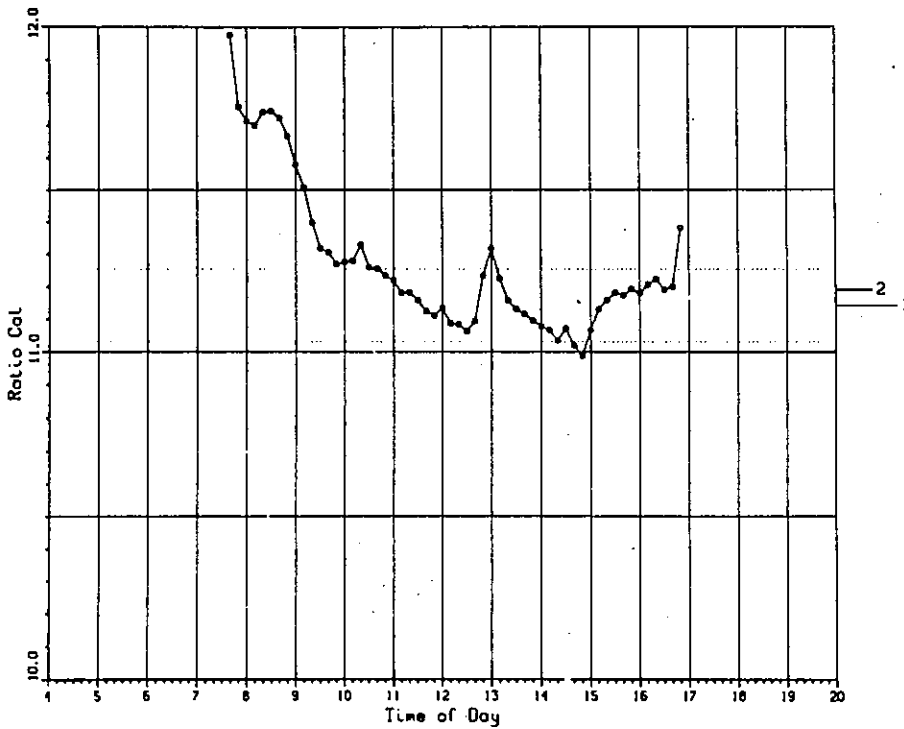

Sensor: KIPP784750
Date: Feb 13, 1981

1. C^m: 11.143
2. Cⁱ: 11.191

FIGURE 22.

Ratio Cal as a Function of Time of Day

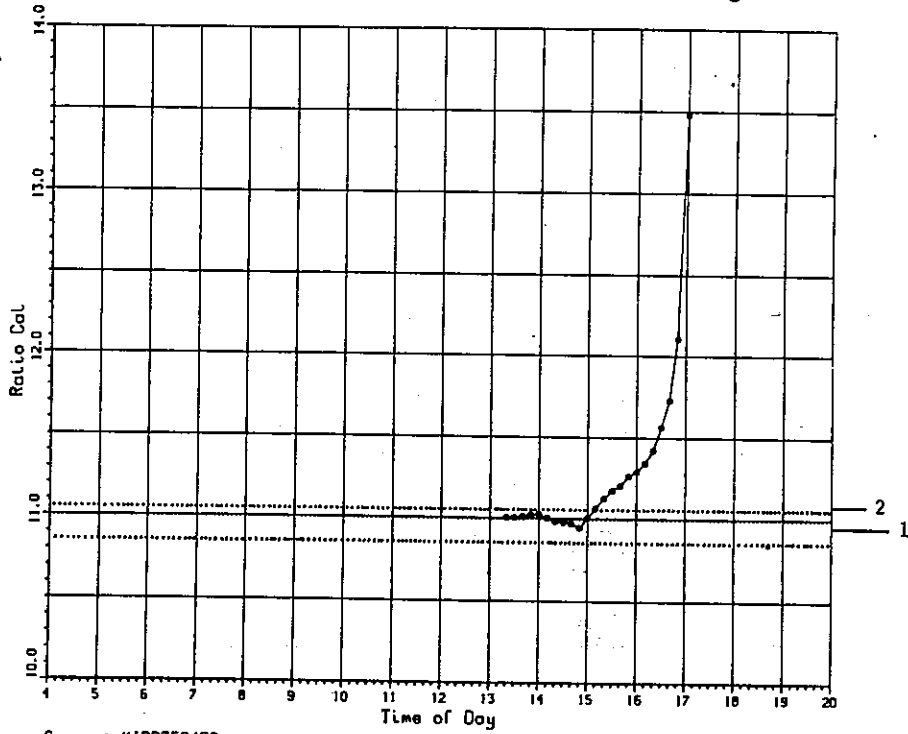

Sensor: KIPP752438
Date: Feb 13, 1981

1. C: 10.955
2. C: 11.087

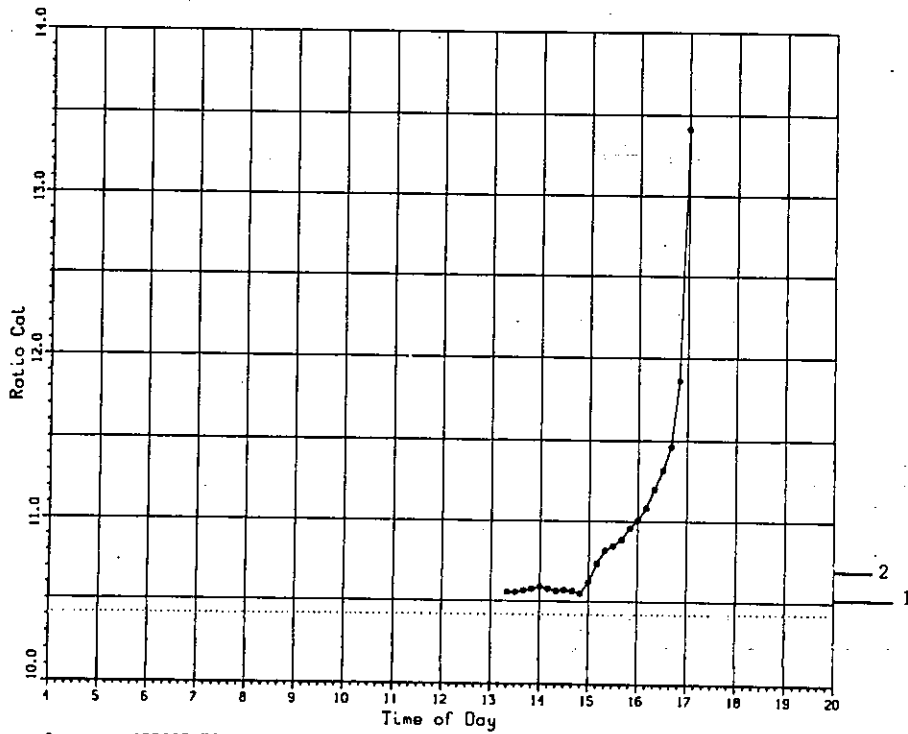

Sensor: KIPP807177
Date: Feb 13, 1981

1. C: 10.516
2. C: 10.701

FIGURE 23.

Ratio Cal as a Function of Time of Day

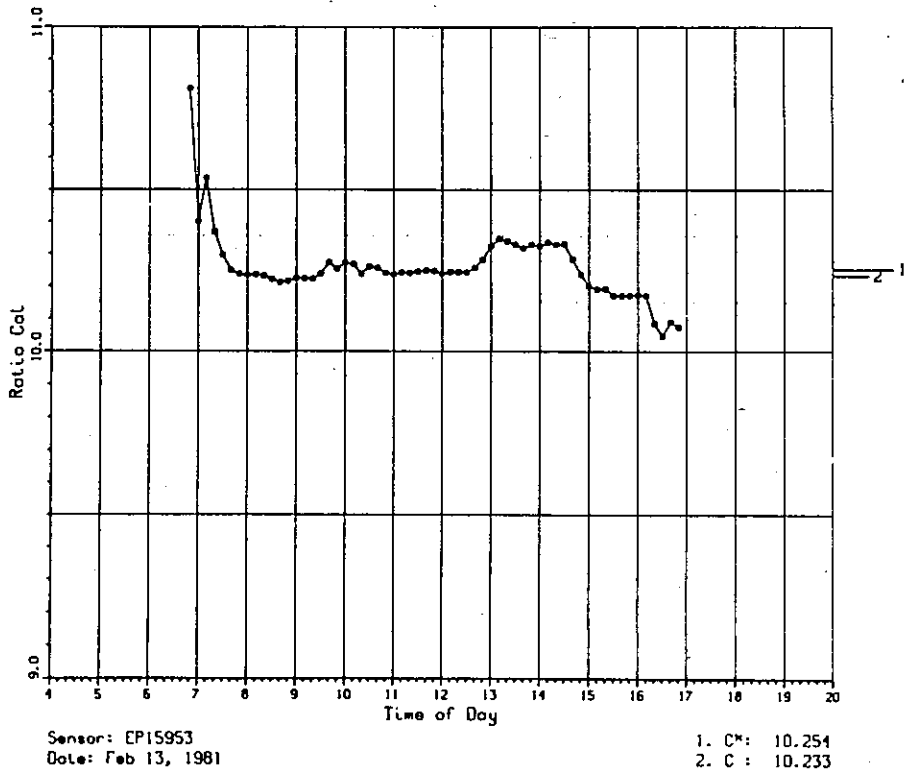
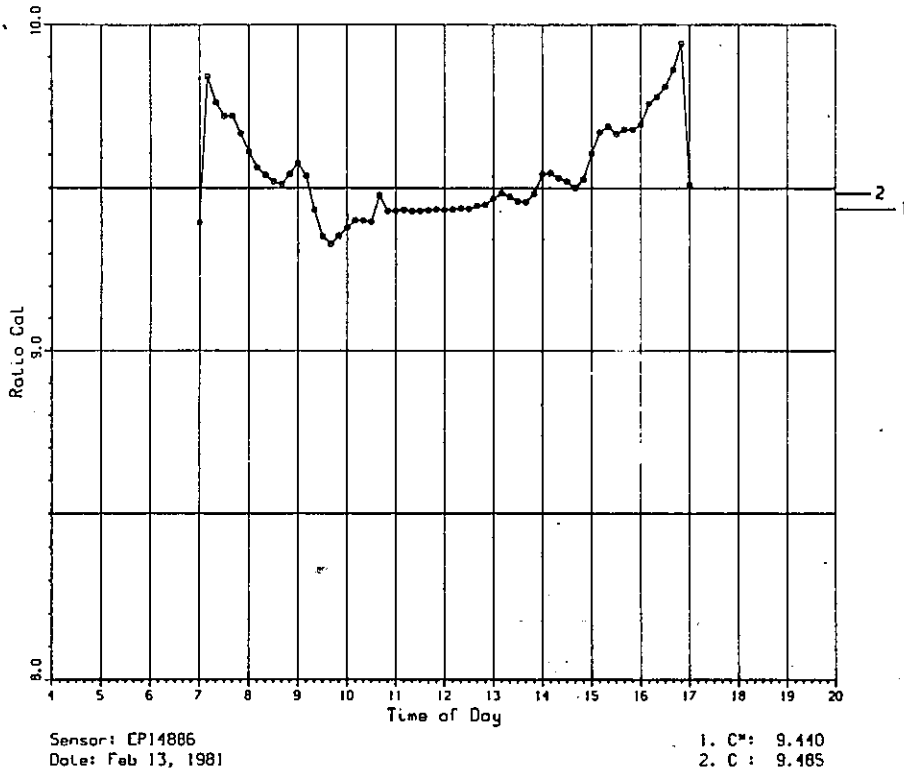

FIGURE 24.

Ratio Col as a Function of Time of Day

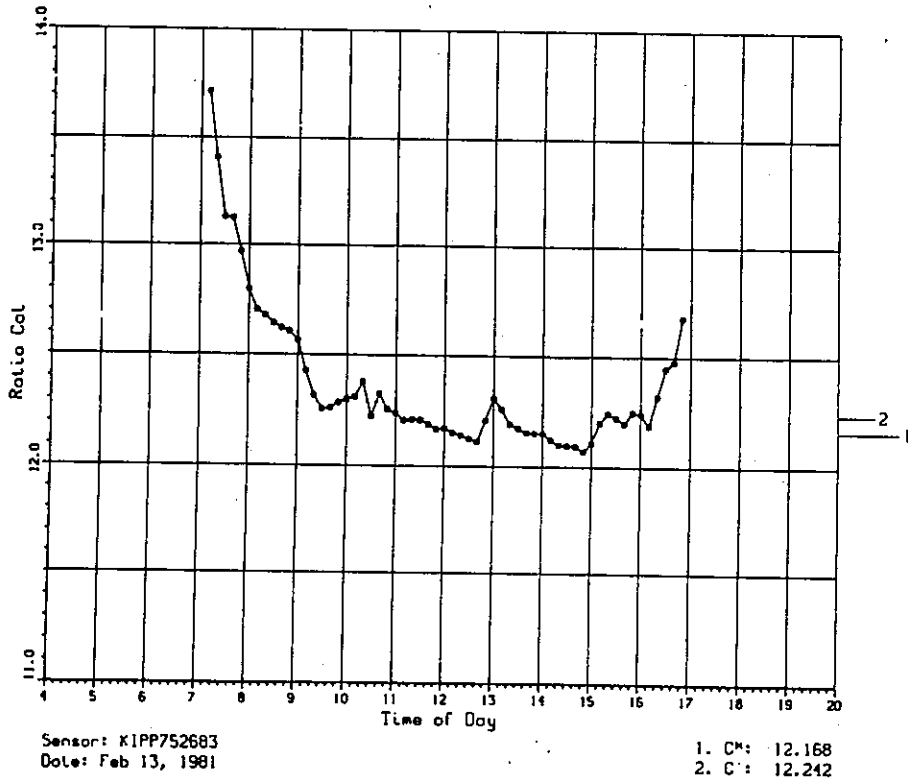
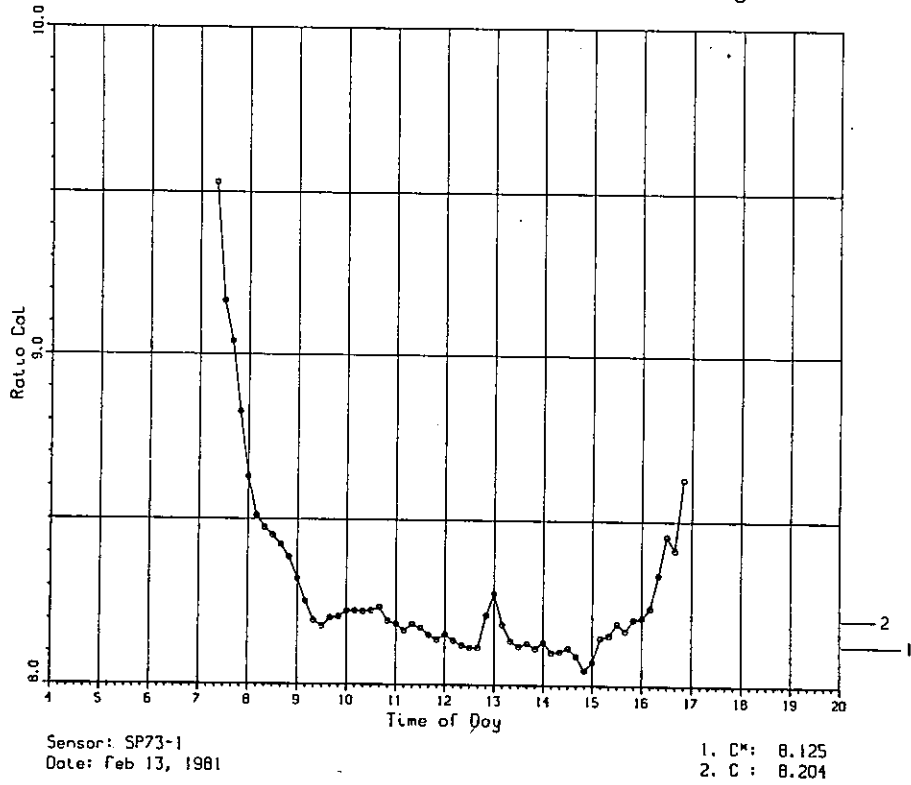
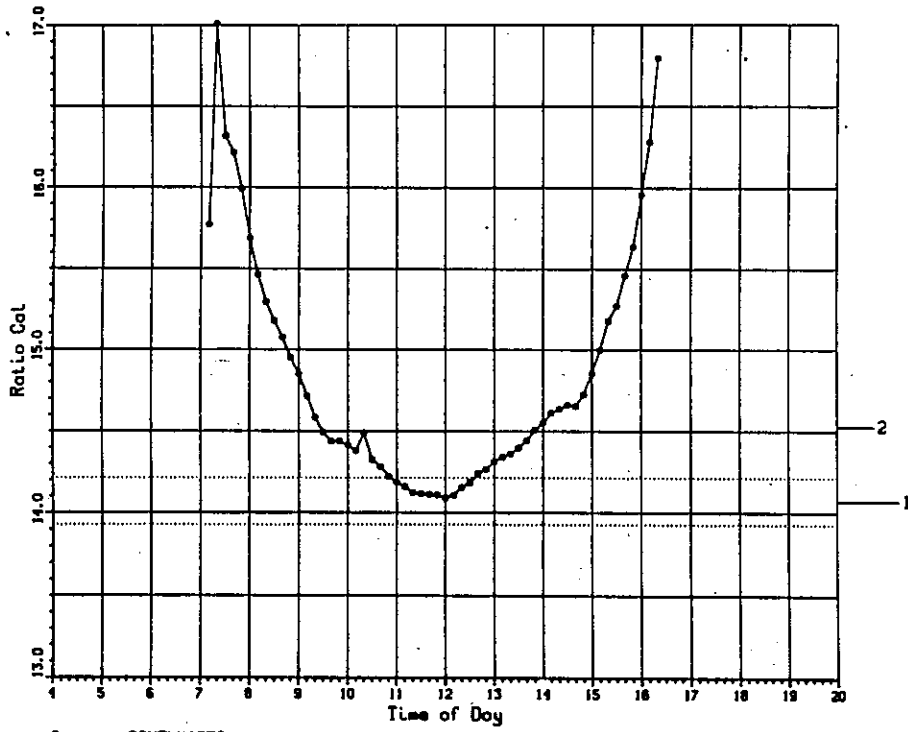

FIGURE 25.

Ratio Cal as a Function of Time of Day



Sensor: SCHOK1676
Date: Feb 13, 1981

1. C^m: 14.072
2. Cⁱ: 14.528

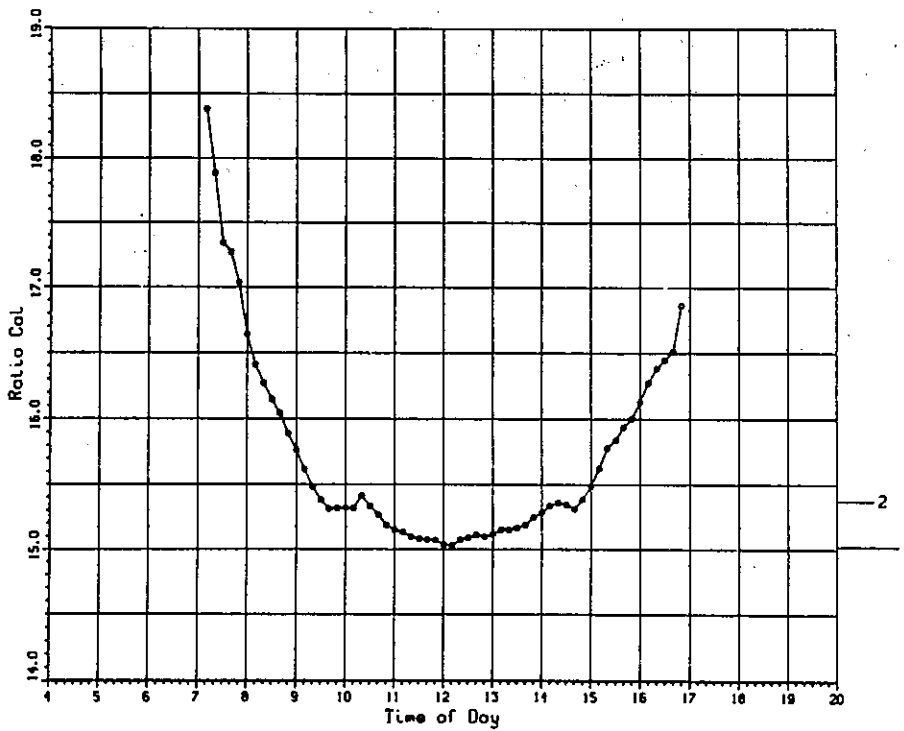

Sensor: KPHL1292
Date: Feb 13, 1981

1. C^m: 15.024
2. Cⁱ: 15.374

FIGURE 26.

Ratio Col as a Function of Time of Day

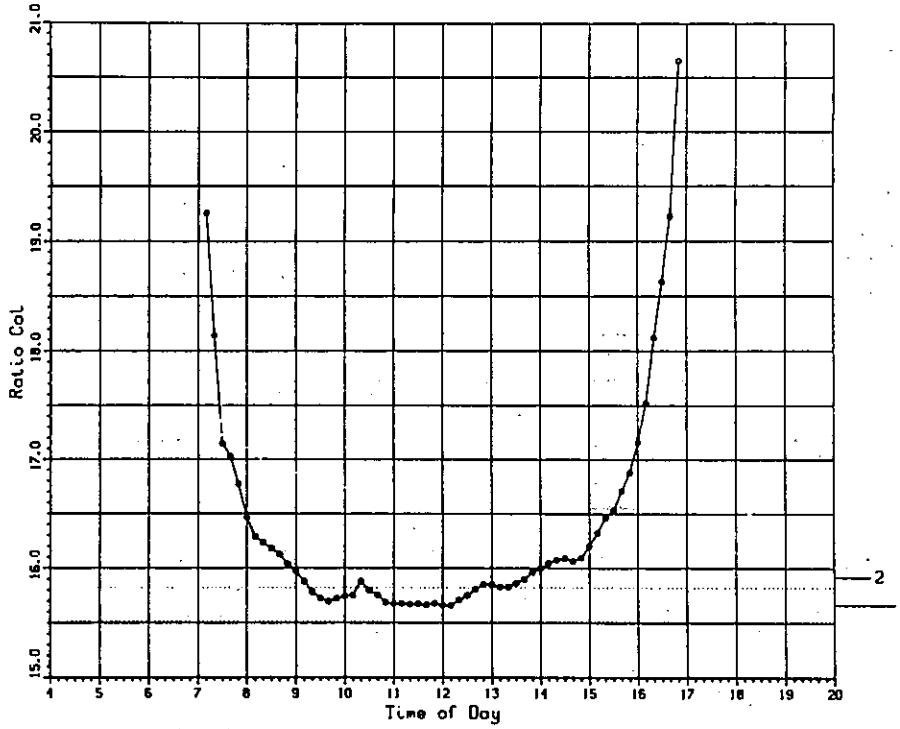

Sensor: SCHENK1681
Date: Feb 13, 1981

1. C^m: 15.668
2. Cⁱ: 15.920

FIGURE 27.

Ratio Cal as a Function of Time of Day

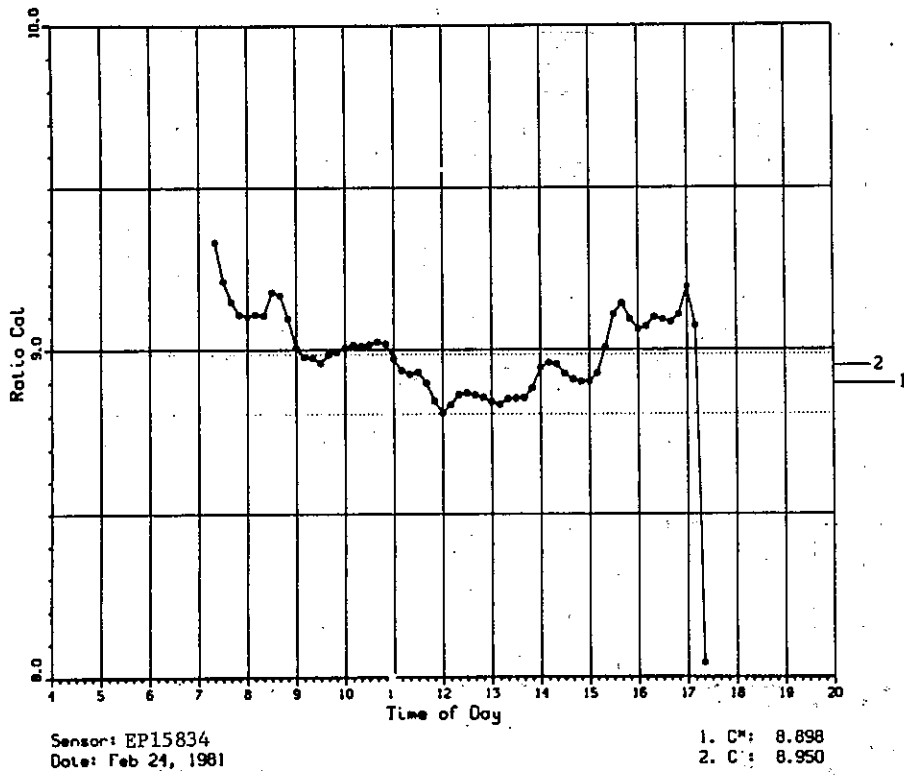
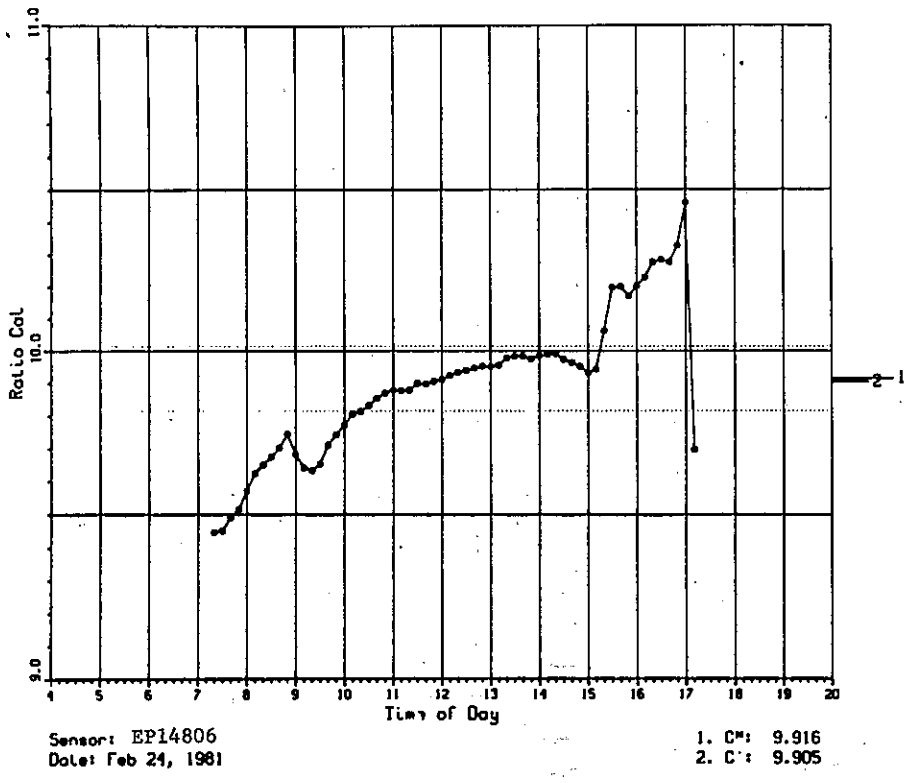

FIGURE 28.

Ratio Cal as a Function of Time of Day

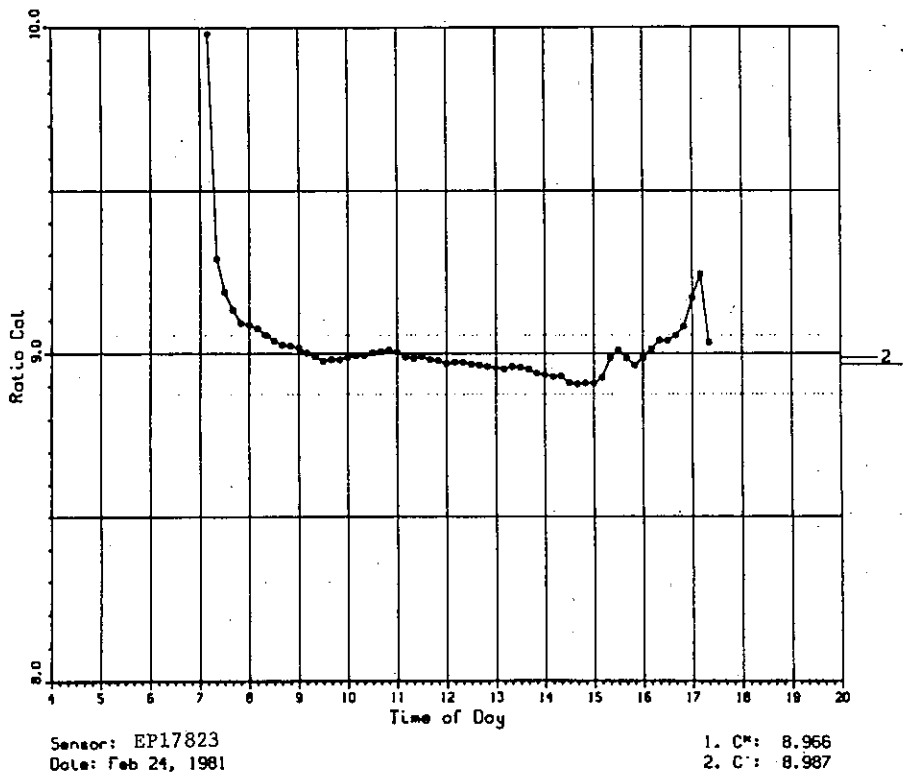
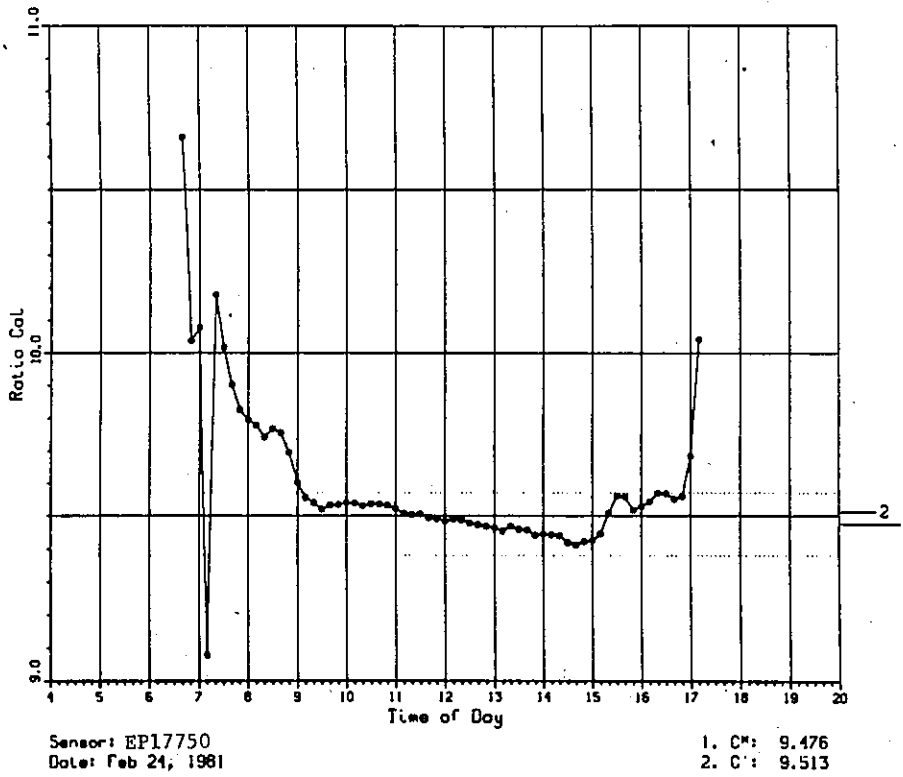

FIGURE 29.

Ratio Cal as a Function of Time of Day

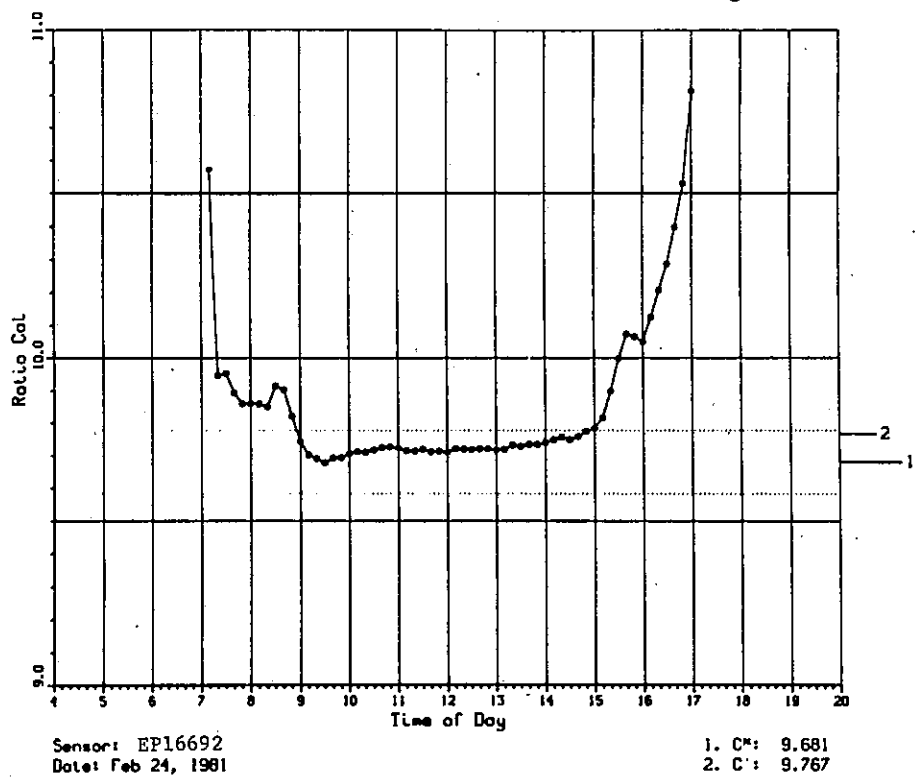
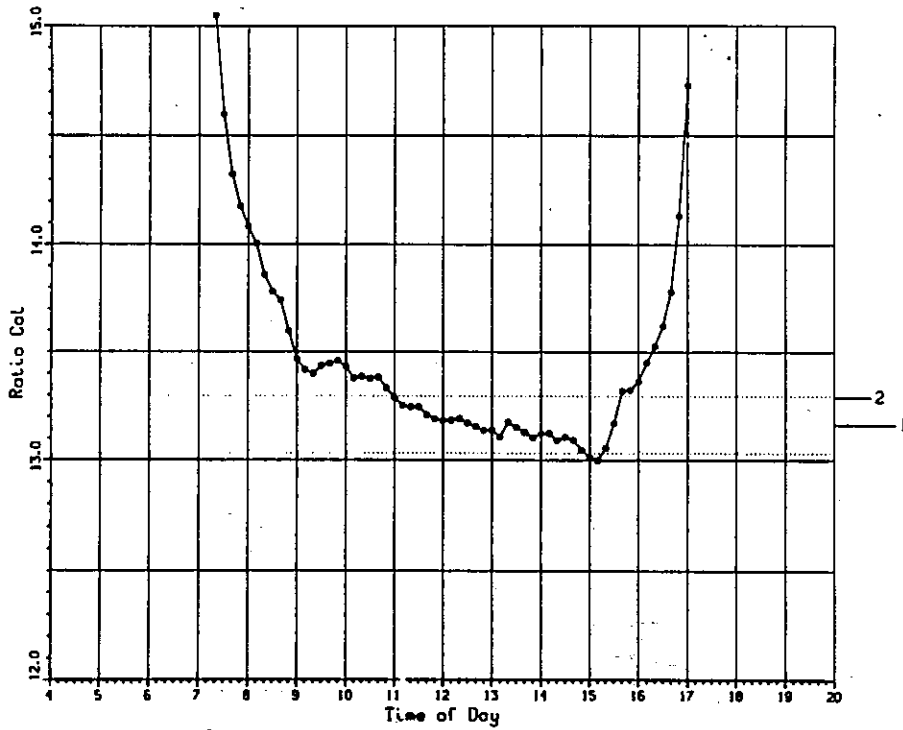

FIGURE 30.

Ratio Col as a Function of Time of Day



Sensor: KIPP774120
Date: Feb 24, 1981

1. C_m: 13.165
2. C_s: 13.290

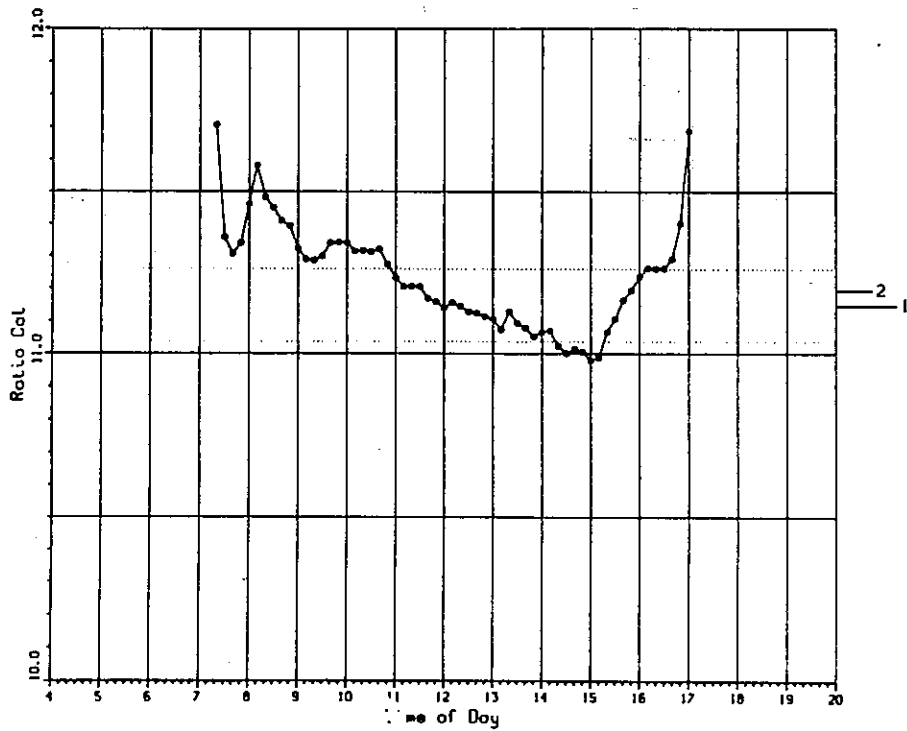

Sensor: KIPP784750
Date: Feb 24, 1981

1. C_m: 11.148
2. C_s: 11.194

FIGURE 31.

Ratio Col as a Function of Time of Day

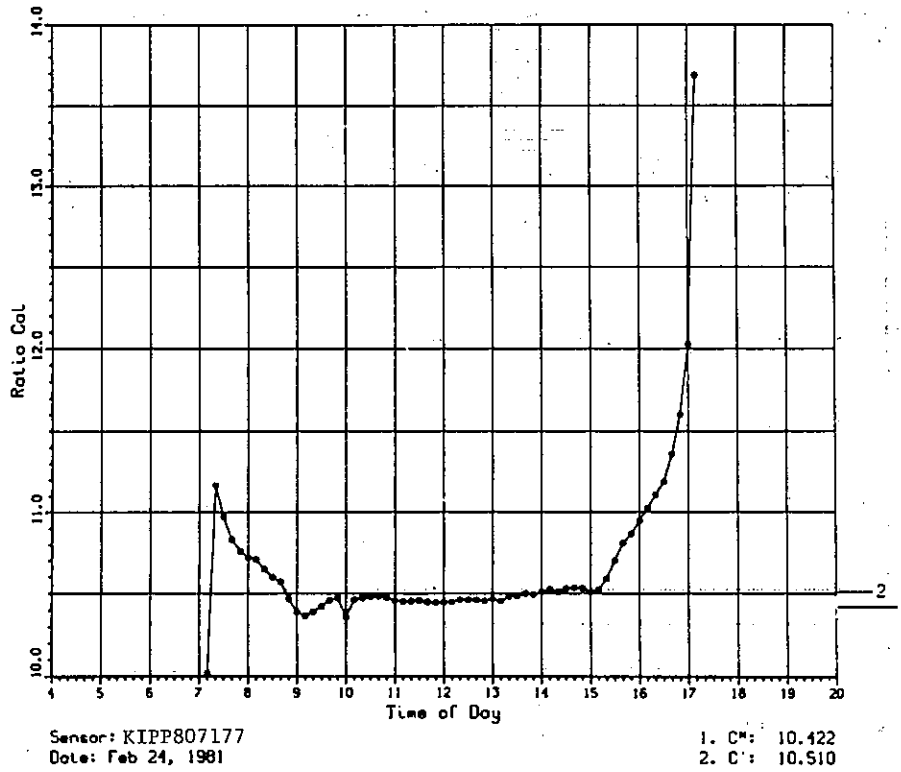
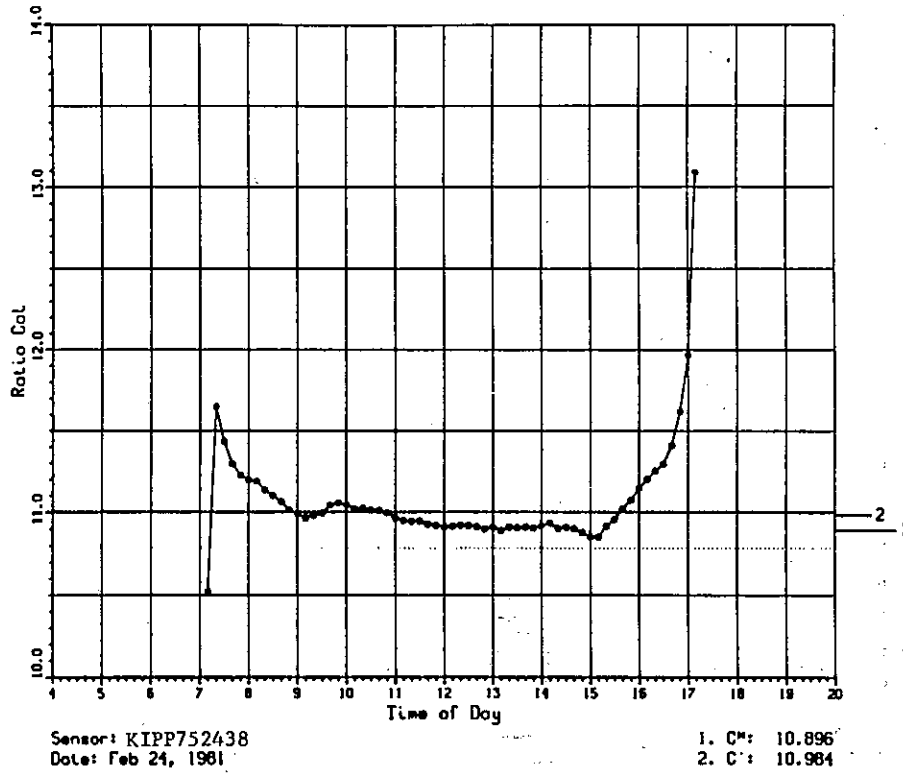

FIGURE 32.

Ratio Cal as a Function of Time of Day

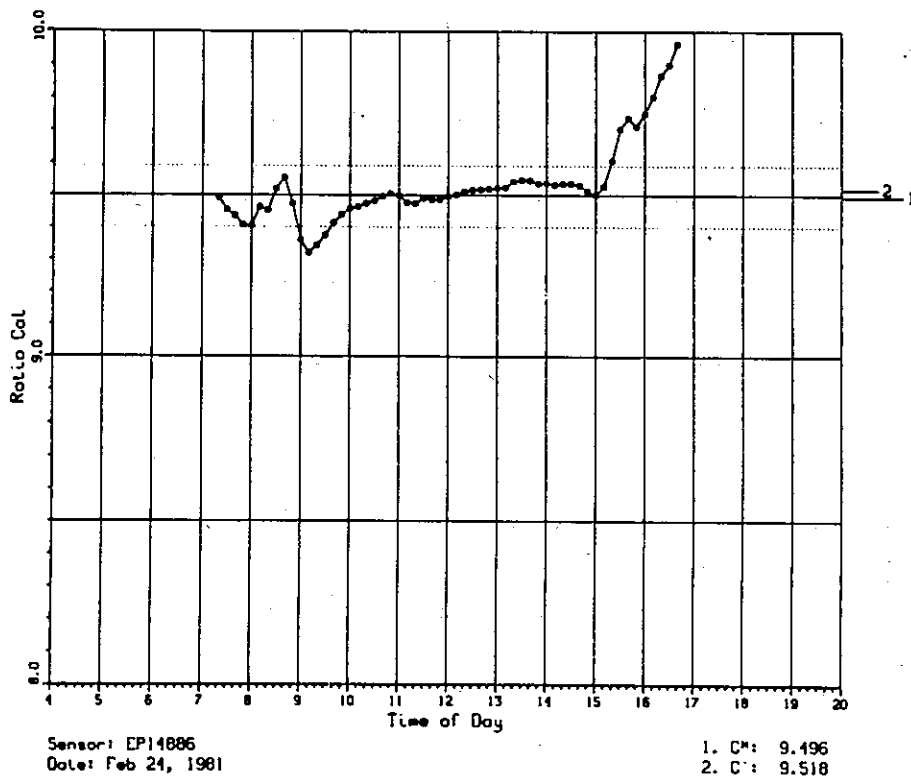
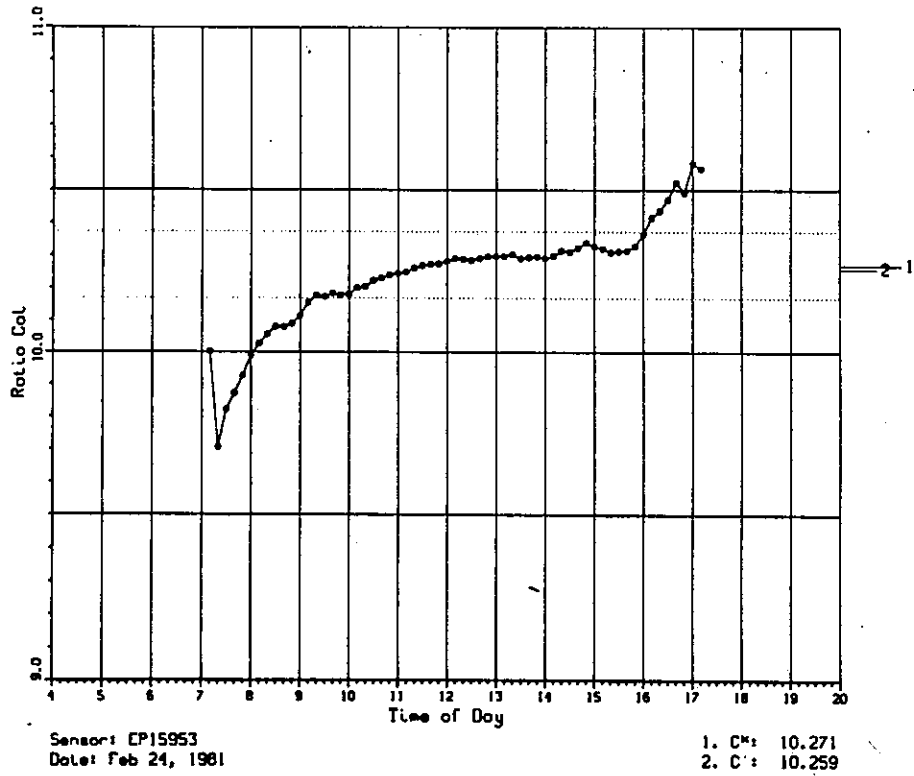

FIGURE 33.

Ratio Col as a Function of Time of Day

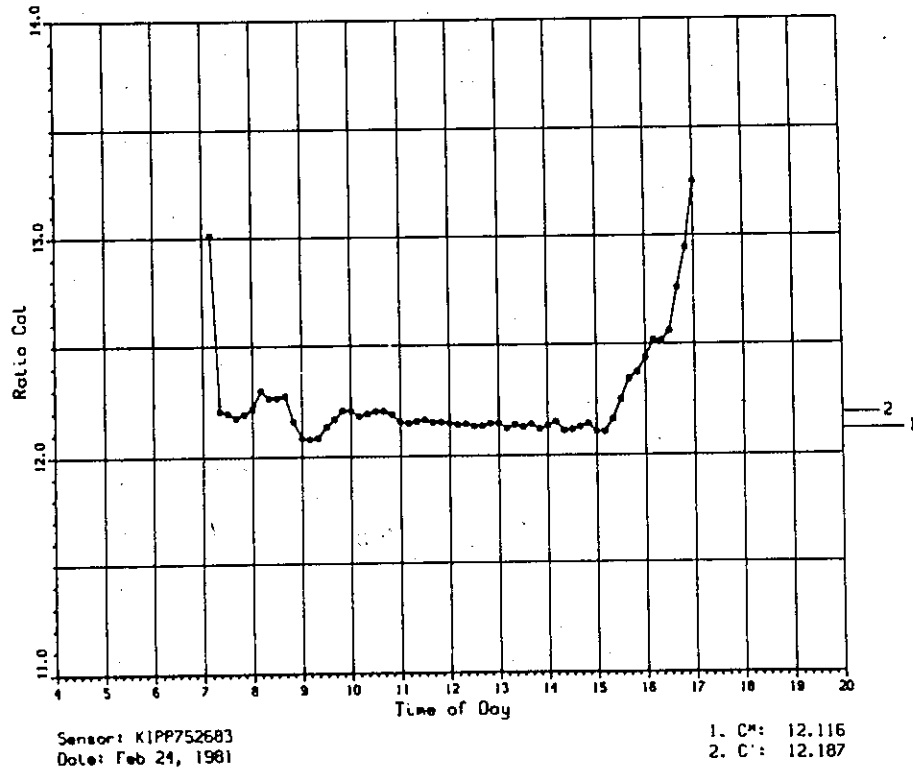
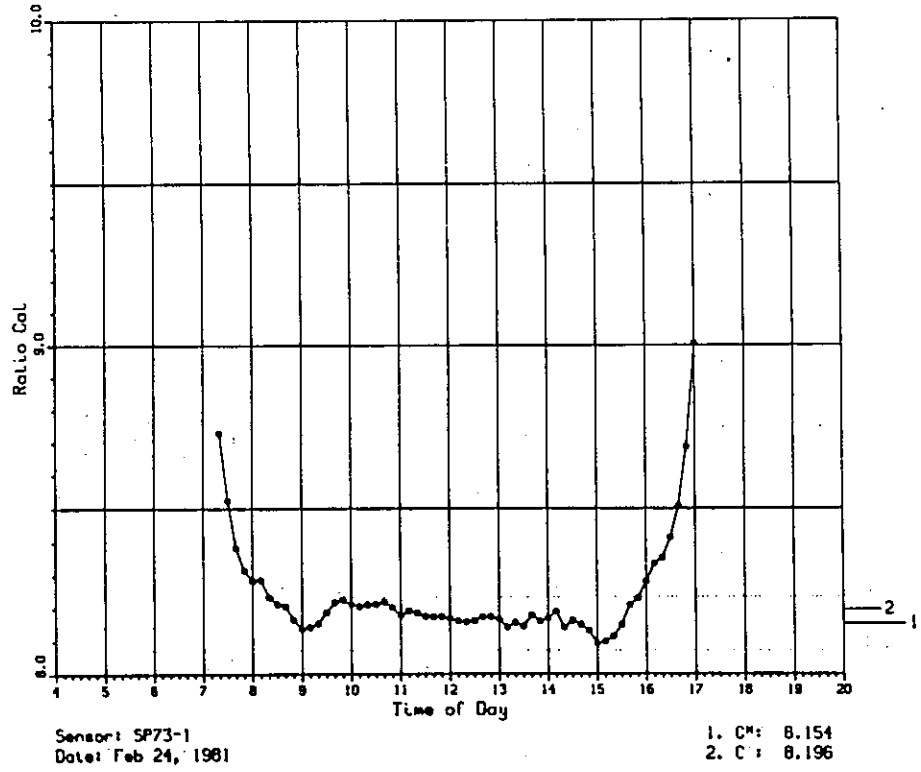

FIGURE 34.

Ratio Cal as a Function of Time of Day

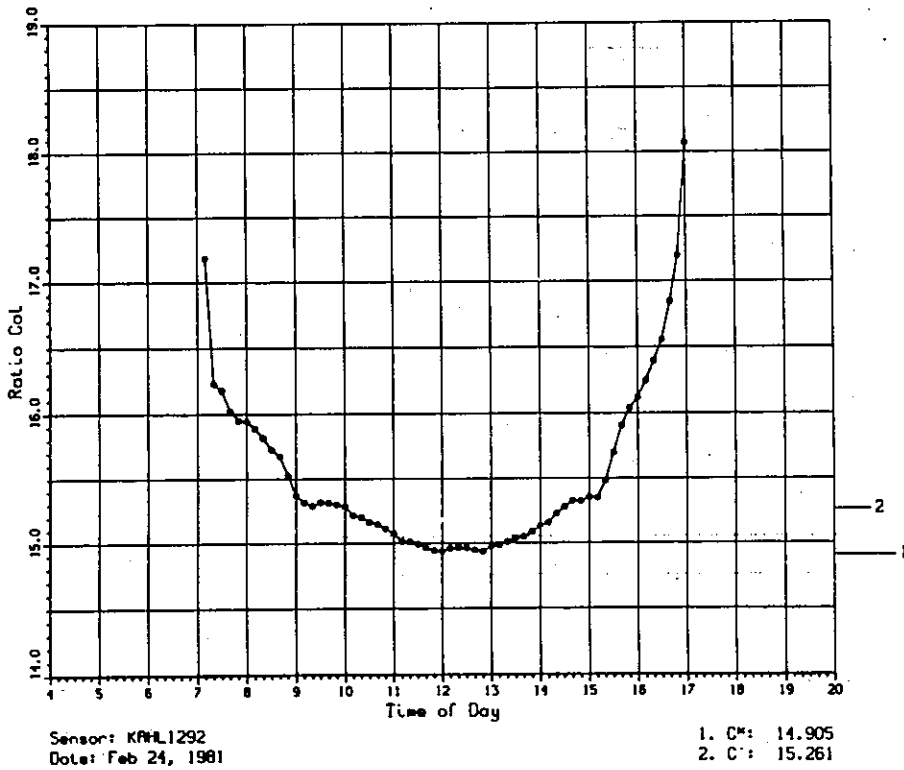
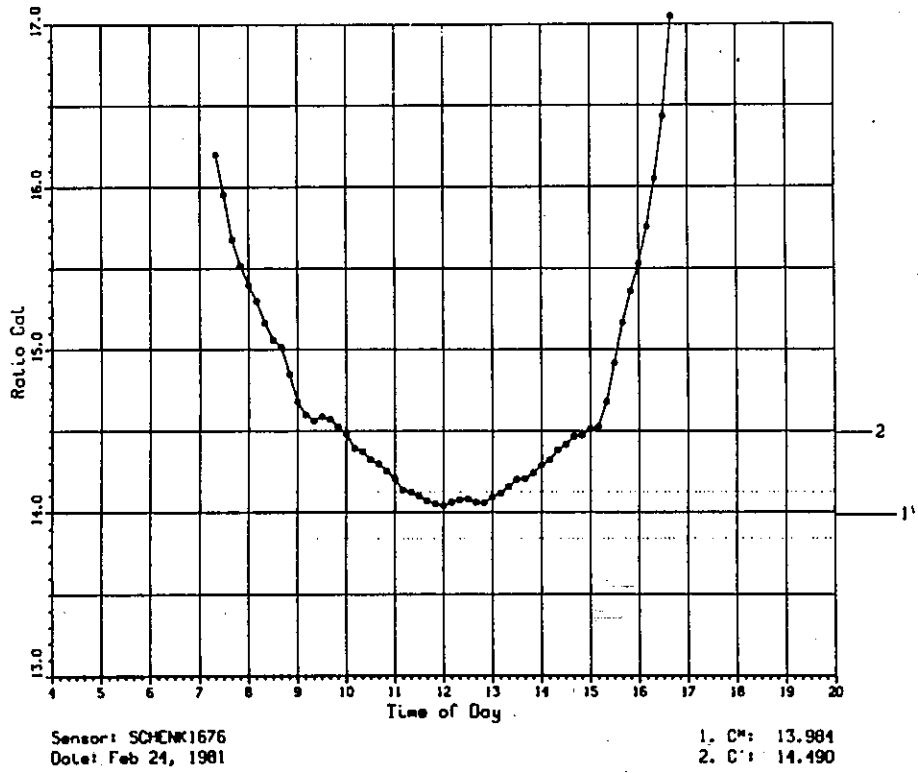

FIGURE 35.

Ratio Cal as a Function of Time of Day

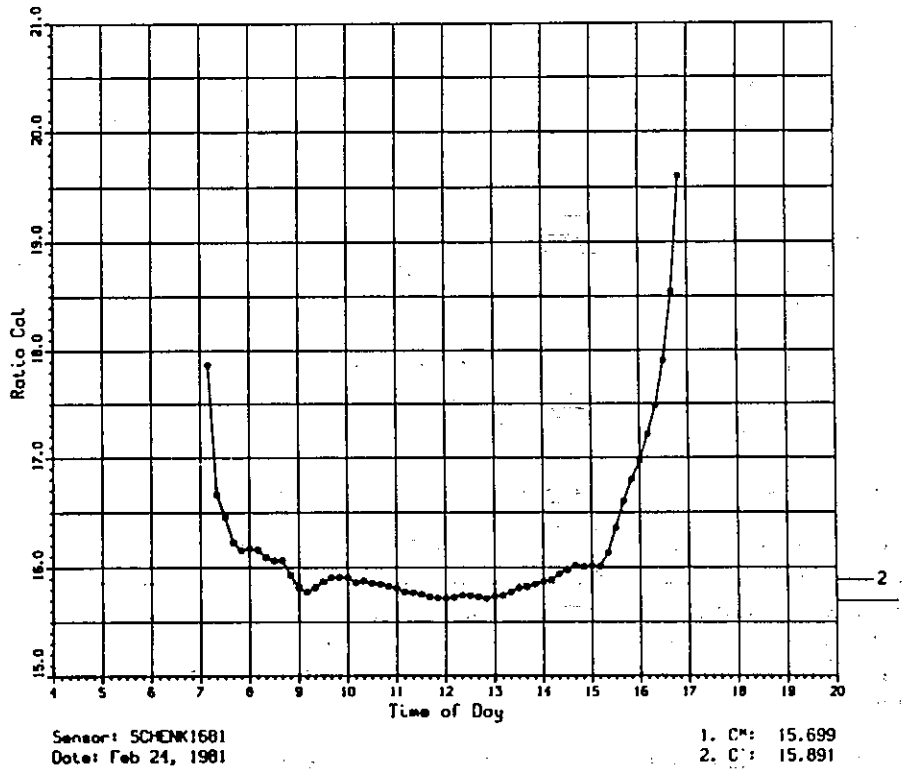

FIGURE 36.

**REPORT OF TESTS BY SRF/NOAA ON PYRANOMETERS FROM THE IEA
COMPARISONS IN DAVOS, MARCH 1980**

by

Edwin Flowers and Rudy Haas, Solar Radiation Facility
Boulder, Colorado

PART IV: Revised Analyses (25 June 1982)

This report contains corrections to calibration values reported in a preliminary paper which was presented at the IEA Pyranometer Conference held in Boulder in March 1981. Results from additional calibrations and tests for temperature, cosine, and azimuth are also reported. The results presented here are regarded as final; the format for the final report of this work, however, will be different.

The corrections to the March 1981 calibration values are to Tables II and IV; items 1 and 2 of Table I and all values in Table III also require correction, but these have not yet been made.

The bases for the corrections to the calibration values are:

1. adoptions of a new reference pyranometer,
2. application of temperature response corrections.

The new reference pyranometer, Eppley PSP 19917F3, was involved in all of the IEA intercomparisons made during the period reported here (January-April 1981), so that the values reported are from direct comparison with the new reference pyranometer. The new reference instrument has excellent characteristics, and tests for cosine, azimuth, and temperature are presented in Figures 1 through 3.

Table I summarizes the new results from the three calibration periods and the limited data from the shade calibrations. The response values are with respect to the calibrations of these instruments done by the AES Canada excepting for the EKO pyranometers which Canada did not calibrate. The response values for EKO are with respect to the original EKO factory calibrations. The new values range from +1.4% to -1.0% with respect to AES Canada. Tables II through V present daily calibration value designated C* which is derived from a regression calculation for the entire period. These two estimates of the calibration value agree closely.

Figures 4 through 12 present results from shade calibrations of selected instruments. The derived calibration values are presented as a function of the solar elevation angle. Some of the plots are incomplete in the sense that they do not cover a sufficiently large range of sun angles. Also indicated on the diagrams are the results of the side by side calibrations with Eppley 19917 as reference (values from Table I) and the AES Canada calibration values. As can be seen these values fit well on the diagrams lending confidence to the side by side derived values. The anomalous behavior of

Eppley 14806 originally reported in my March 1981 paper, is clearly evident in the diagram for the shade calibration where the AM and PM data points follow separate paths. The azimuth response test for this instrument (Figure 18) verifies these results. The cause for this behavior would appear to be a levelling problem but in addition the black receiving surface is badly off center with respect to the inner dome and this could also possibly contribute to the observed behavior.

Figures 13-18 present azimuth response curves for some of the instruments which were obtained from outdoor experiments. Time restrictions prevented a more complete mapping of this characteristic over a range of solar elevation angles as was carried out by McGregor and reported at the March 1981 meeting.

Figures 19-39 give temperature response curves for all the pyranometers, normalized to 25°C.

TABLE I

SUMMARY - CALIBRATION OF IEA PYRANOMETERS BY SRF, BOULDER, CO.

A. HORIZONTAL EXPOSURE, REFERENCE: Eppley PSP 19917F3, C=10.105

SENSORS	JAN 30-FEB 25		1981		APR 1-28		SHADE CALIBRATION REF: TMI 67502 SUN ELEV.=50
	C*	R	C*	R	C*	R	
EPPLEY PSP							
14806	9.70	1.004			9.76	1.010	9.65AM/9.86PM
16692	9.46	0.990					
17750	9.25	1.001			9.27	1.003	9.26
17823	8.76	1.010					
18978			10.61 ⁵	1.000 ⁵			
19129			10.46	1.013			10.48
KIPP CM-6							
752438	10.59 ⁵	1.014					
763000			11.40	1.005			
773656			11.57	1.008	11.64	1.014	11.70
773992			12.11	1.012	12.09	1.010	12.15
774120	12.72	1.013			12.70	1.011	12.66
784750	10.76	0.995			10.84	1.002	
785047			11.64	0.997	11.68	1.000	11.74
807177	10.13	1.000					
KIPP CM-10							
790059			5.70 ⁵	1.010	5.70 ⁵	1.010	5.70
800077			5.82	0.998			
SCHENK							
1626			14.40	0.992	14.37	0.990	14.44
EKO MS-42							
A81901			8.28	1.004 ⁵ *	8.21	0.997*	
A81902			7.24 ⁵	1.021 *	7.19	1.014*	7.15
A81903			8.00 ⁵	1.020 *	7.92	1.009*	

B. 40° TILT - SOUTH FACING, REFERENCE: Eppley 14889F3, C=9.187

EPPLEY PSP							
17750					9.28 ⁵	1.005	
EKO MS-42							
A81903					7.87	1.002 ⁵ *	
SCHENK							
1626					14.05	0.968	

NOTE: RESPONSE VALUES ARE WITH RESPECT TO AFS CANADA EXCEPTING *VALUES ARE WITH RESPECT TO EKO.

TABLE II

DAILY CALIBRATION VALUES/REGRESSION METHOD, TEMPERATURE CORRECTED, SRF, BOULDER, CO.
 REFERENCE: Eppley PSP 19917F3, C=10.105

DATE	EP14806	EP15834	EP16692	EP17750	EP17823	K752438	K774120	K784750	K807177	t (°C)	TSN SOLAR ELEVATION
1981											33.5
JAN 30	9.66 (9.84)	8.76 (8.87)		9.25 (9.38)	8.73 (8.83)		12.74 (12.76)	10.72 (11.01)		-3 (-3)	
JAN 31	9.74	8.81		9.30	8.77		12.67	10.78		-7	
FEB 1	9.68	8.76		9.25	8.75		12.68	10.66		-1	
2	9.66	8.80		9.34	8.83		12.81	10.94		0	
3	9.69	8.78		9.28	8.77		12.76	10.76		-4	
4	9.69	8.76		9.27	8.77		12.73	10.73		1	
5	9.80	8.82		9.31	8.80		12.75	10.92		5	
6	(9.61)	(8.81)		(9.31)	(8.82)		(12.83)	(10.89)		(-6)	
7	9.64	8.74		9.23	8.72		12.73	10.66		3	
8	9.76	8.79		9.27	8.78		12.72	10.74		-6	
9	(9.95)	(8.90)		(9.40)	(8.83)		(12.83)	(10.97)		(-21)	
10	9.78	8.79		9.27	8.75		12.67	10.70		-12	
11	9.75	8.82		9.30	8.80		12.76	10.82		8	
12	9.71	8.79	9.46	9.26	8.78	10.60	12.78	10.78	10.18	11	36.8
13	9.75	8.78	9.47	9.26	8.74	10.59	12.70	10.77	10.18	15	
14	9.75	8.71	9.42	9.21	8.72	10.59	12.80	10.76	10.10	11	
15	9.62	8.71	9.45	9.24	8.75	10.63	12.82	10.80	10.15	10	
16	9.69	8.78	9.45	9.28	8.75	10.58	12.65	10.68	10.16	12	
17	9.77	8.77	9.47	9.24	8.76	10.58	12.76	10.91	10.10	11	
18	9.65	8.76	9.43	9.24	8.72	10.56	12.73	10.78	10.10	16	38.9
19	9.62	8.73	9.40	9.21	8.72	10.56	12.74	10.76	10.04	12	
20	9.65	8.72	9.43	9.23	8.75	10.53	12.74	10.76	10.04	12	
21	9.75	8.76	9.49	9.25	8.77	10.63	12.73	10.79	10.18	3	
22	9.75	8.74	9.45	9.26	8.78	10.62	12.77	10.84	10.15	7	
23	9.71	8.80	9.46	9.27	8.75	10.61	12.76	10.96	10.23	11	
24	9.76	8.75	9.47	9.27	8.80	10.59	12.75	10.83	10.13	12	
25	9.74	8.73	9.46	9.24	8.74	10.59	12.72	10.86	10.12	14	41.1
N	24	24	13	24	24	13	24	24	24	24 / 13	
AVG	9.709	8.768	9.451	9.262	8.766	10.592	12.739	10.790	10.140	5 / 11	
σ	.0526	.0315	.0238	.0309	.0342	.0292	.0426	.0825	.0481		
σ/AVG	+ .54%	+ .36%	+ .25%	+ .33%	+ .39%	+ .28%	+ .33%	+ .76%	+ .47%		
REGRESSION FOR THE ENTIRE PERIOD											
N	27/1496	27/1519	13/739	27/1518	27/1511	13/718	27/1484	27/1490	13/697		
C*	9.697	8.757	9.456	9.251	8.755	10.595	12.720	10.758	10.127		

NOTE: Daily values in () were not used in the summary of daily values; these days were included in the summary for the entire period

TABLE III
 DAILY CALIBRATION VALUES/REGRESSION METHOD, TEMPERATURE CORRECTED, SRF, BOULDER, CO.
 REFERENCE: Eppley PSP 19917F3, C=10.105

DATE	EF18978	EP19129	K763000	K773656	K773992	K785047	K790059	K800077	SCH1626	PK0901	PK0902	PK0903	t (°C)	TSN SOLAR ELEVATION
MAR 9														
10	10.59	10.46		11.55	12.10		5.70	5.82		8.28	7.25	7.95	5	46.1
11	10.61	10.47		11.58	12.15		5.72	5.83		8.25	7.24	7.99	4	
12	10.62	10.46		11.57	12.16		5.73	5.83		8.28	7.28	8.00	5	
13	10.64	10.48	11.42	11.58	12.12	11.61	5.73	5.83	14.36	8.27	7.24	8.01	6	
14	10.65	10.51	11.43	11.62	12.16	11.66	5.72	5.84	14.39	8.31	7.30	8.02	7	
15	10.64	10.45	11.41	11.56	12.11	11.63	5.73	5.83	14.48	8.28	7.27	8.00	7	
16	10.66	10.43	11.43	11.60	12.13	11.65	5.73	5.84	14.49	8.26	7.23	8.02	10	
17	10.60	10.44	11.41	11.57	12.12	11.63	5.72	5.84	14.45	8.26	7.26	7.99	12	
18	10.64	10.50	11.46	11.61	12.12	11.70	5.72	5.83	14.44	8.29	7.27	8.04	9	
19	10.61	10.45	11.40	11.55	12.12	11.65	5.73	5.85	14.41	8.28	7.26	7.98	2	
20	10.66	10.51	11.51	11.67	12.25	11.80	5.71	5.82	14.45	8.27	7.24	7.99	3	
21	10.62	10.52	11.52	11.68	12.22	11.86	5.65	5.83	14.67	8.36	7.24	8.06	4	50.0
22	10.62	10.47	11.37	11.56	12.10	11.65	5.69	5.74	14.48	(8.18)	7.23	8.01	7	
23	10.56	10.41	11.39	11.56	12.11	11.65	5.70	5.80	14.42	8.27	7.23	8.01	7	
24	10.64	10.49	11.50	11.62	12.19	11.77	5.73	5.81	14.34	8.28	7.20	8.02	10	
25	10.64	10.49	11.44	11.61	12.13	11.69	5.69	5.81	14.59	8.41	7.30	8.09	4	
26	10.64	10.48	11.45	11.67	12.19	11.73	5.72	5.82	14.41	8.24	7.21	7.95	9	
27	10.59	10.44	11.38	11.58	12.09	11.63	5.71	5.84	14.49	8.26	7.20	7.99	14	
28								5.83	14.36	8.25	7.21	8.00	11	
29	10.59	10.46	11.38	11.57	12.12	11.67	5.71	5.81	14.31	8.27	7.21	8.01	10	
30	10.56	10.41	11.37	11.53	12.10	11.61	5.70	5.79	14.38	8.27	7.18	8.03	10	
31	10.60	10.44	11.41	11.61	12.11	11.68	5.72	5.82	14.33	8.25	7.20	7.98	7	54.3

SHOW - INSTRUMENTS COVERED

	21	21	18	21	19	21	22	19	21	21	21/19
N	10.617	10.465	11.426	11.592	12.138	11.679	5.710	5.819	14.434	8.281	7.238
AVG	.0299	.0321	.0475	.0417	.0424	.0665	.0194	.0221	.0897	.0387	8.005
σ	±.28%	±.31%	±.42%	±.36%	±.35%	±.57%	±.34%	±.38%	±.62%	±.47%	.0314
σ/AVG											±.39%

REGRESSION FOR THE ENTIRE PERIOD
 N 21/1404 21/1413 19/1226 21/1380 21/1369 19/1241 21/1363 22/1423 19/1215 22/1438 22/1425 22/1426
 C* 10.615 10.458 11.397 11.569 12.110 11.642 5.705 5.817 14.397 8.277 7.238 8.006

TABLE IV

DAILY CALIBRATION VALUES/REGRESSION METHOD, TEMPERATURE CORRECTED, SEP, BOULDER, CO.

DATE 1981 MPP	REFERENCE: EpPley PSP 19917F3, C=10.105												FK0903 t (OC)	TSU SOLAR ELEVATION
	EP14806	EP17750	F773656	F773902	F774120	K785047	F790059	SC11626	FK0901	FK0902	FK0903	t (OC)		
1	9.81	9.27	12.09	10.80	11.67	5.71	14.45	8.25	7.20	7.96	15	54.7		
2	9.82	9.28	12.08	10.81	11.66	5.70	14.41	8.27	7.22	7.99	17			
3														
4	9.80	9.20	12.18	10.89	11.75	5.74	14.41	8.29	7.28	8.00	3			
5	9.79	9.20	12.09	10.85	11.70	5.72	14.36	8.27	7.19	7.96	9			
6														
7														
8	9.80	9.26	12.12	10.89	11.74	5.72	14.47	8.29	7.18	7.95	17			
9	9.73	9.27	12.10	10.89	11.75	5.71	14.31	8.31	7.23	8.01	11			
10	9.72	9.26	12.07	10.83	11.73	5.68	14.32	8.22	7.17		8			
11	9.73	9.28	12.10	10.89	11.72	5.70	14.39	8.18	7.12		16			
12	9.73	9.27	12.07	10.85	11.72	5.73	14.49	8.18	7.12		16			
13	9.79	9.27	12.07	10.84	11.74	5.70	14.40	8.21	7.15		17			
14	9.78	9.28	12.08	10.82	11.74	5.71	14.43	8.25	7.17		13			
15	9.78	9.29	12.15	10.85	11.66	5.70	14.41	8.22	7.19		12			
16	9.76	9.20	12.06	10.82	11.64	5.69	14.43	8.23	7.20		13			
17	9.68	9.20	12.06	10.84	11.66	5.71	14.32	8.26	7.20		19			
18	9.75	9.28	12.13	10.87	11.65	5.72	14.43	8.20	7.15		21			
19													50.6	
20	9.77	9.28	12.21	10.90	11.74	5.69	14.58	8.27	7.22		16			
21	9.71	9.27	12.09	10.92	11.75	5.67		8.31	7.23		11			
22	9.83	9.28	12.07	10.81	11.66	5.69		8.25	7.17		18			
23	9.76	9.26	12.16		11.75	5.72		8.28	7.24		11			
24	9.77	9.26	12.15	12.72	11.70	5.69		8.21	7.22		15			
25	9.67	9.27	12.10	12.73	11.69	5.69	14.31	8.24	7.26		21			
26	9.71	9.25	12.12	12.67	11.65	5.70	14.37	8.21	7.19		22			
27													23	
28													22	
												17	64.3	

n	REGRESSION FOR THE ENTIRE PERIOD											
	17	19	24	7	10	25	24	25	23	25	23	6
AVG	9.758	9.265	12.106	12.693	10.851	11.690	5.704	14.402	8.234	7.192	7.987	
σ	.0436	.0276	.0331	.0432	.0356	.0456	.0160	.0731	.0460	.0410	.0577	
n/AVG	±.457	±.307	±.332	±.347	±.337	±.397	±.282	±.517	±.537	±.572	±.722	

REGRESSION FOR THE ENTIRE PERIOD												
N	22/1555	17/1203	19.1339	24/1681	8/532	19/1308	25/1758	24/1702	22/1522	26/1873	23/1625	6/381
C*	9.760	9.267	11.639	12.004	12.696	10.836	11.681	5.706	14.370	8.213	7.189	7.979

TABLE V

DAILY CALIBRATION VALUES/REGRESSION METHOD, TEMPERATURE CORRECTED, SRF, BOULDER, CO.

40° TILT - SOUTH FACING

REFERENCE: Eppley PSP 14889F3, C=9.187

DATE 1981	EP17750	SCH1626	EKO 903	(t(°C))	TSN SOLAR ELEVATION
APR 8			7.88	8	
9			7.87	16	
10			7.86	14	
11			7.85	16	
12			7.84	17	
13			7.89	13	
14			7.86	12	58.6
15			7.88	13	
16			7.87	19	
17			7.88	21	
18			7.91	16	
19	RAIN THRU DAY				
20					
21	9.26	14.02		18	
22	9.29	14.13		11	
23	9.29			15	
24	9.29			21	
25	9.29			22	
26	9.28			23	
27	9.28			22	
<hr/>					
N	7	2	11		
AVG	9.282	14.076	7.871		
σ	.0103		.0201		
σ /AVG	<u>±.11%</u>		<u>±.26%</u>		
REGRESSION FOR THE ENTIRE PERIOD					
N	7/570	2/164	14/1065		
C*	9.285	14.049	7.870		
TILT/HOR	1.002	0.978	0.985		

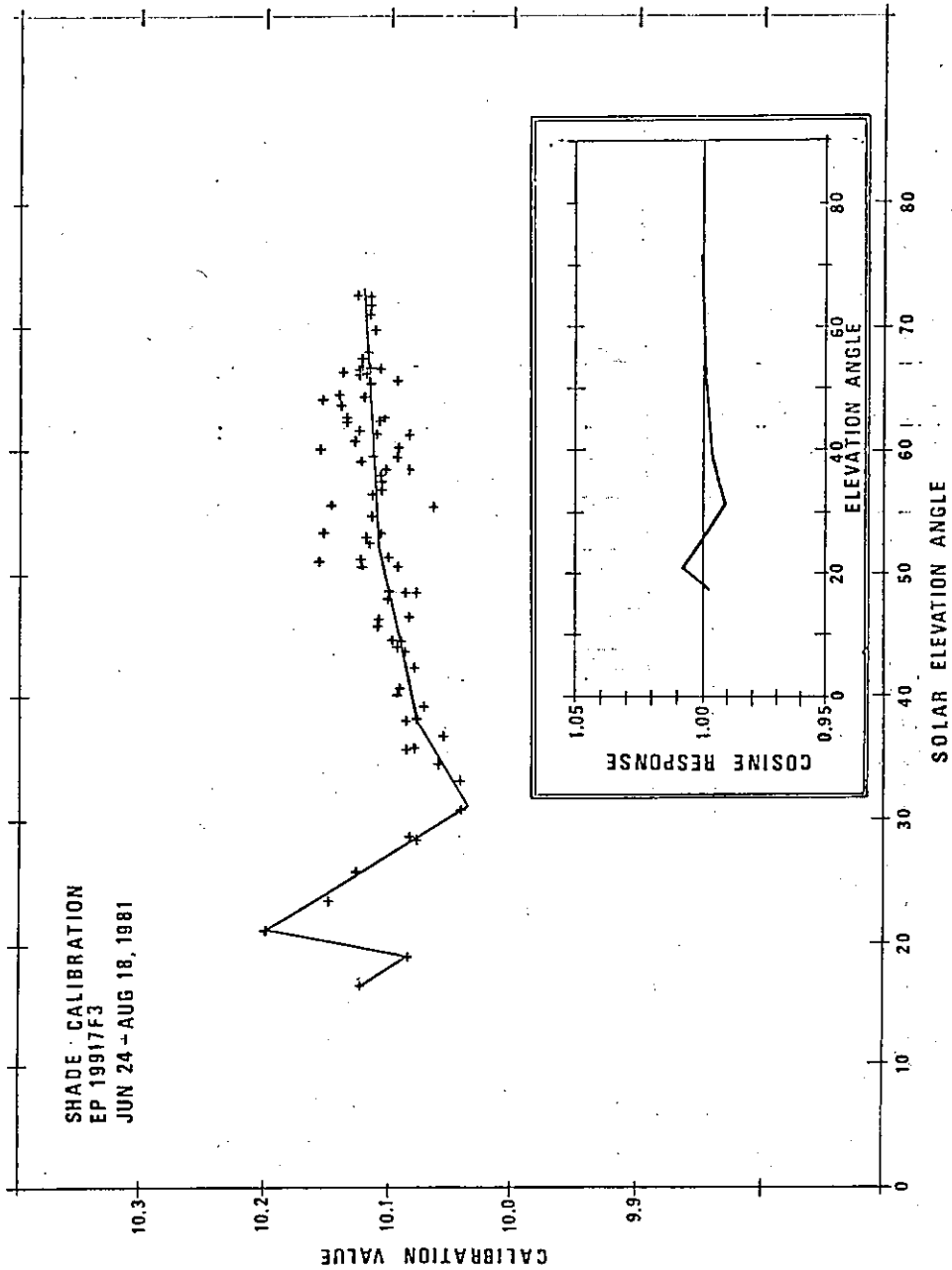

Figure 1: Shade calibration results for new NOAA/SRF reference pyranometer, Eppley PSP s/n 19917F3.

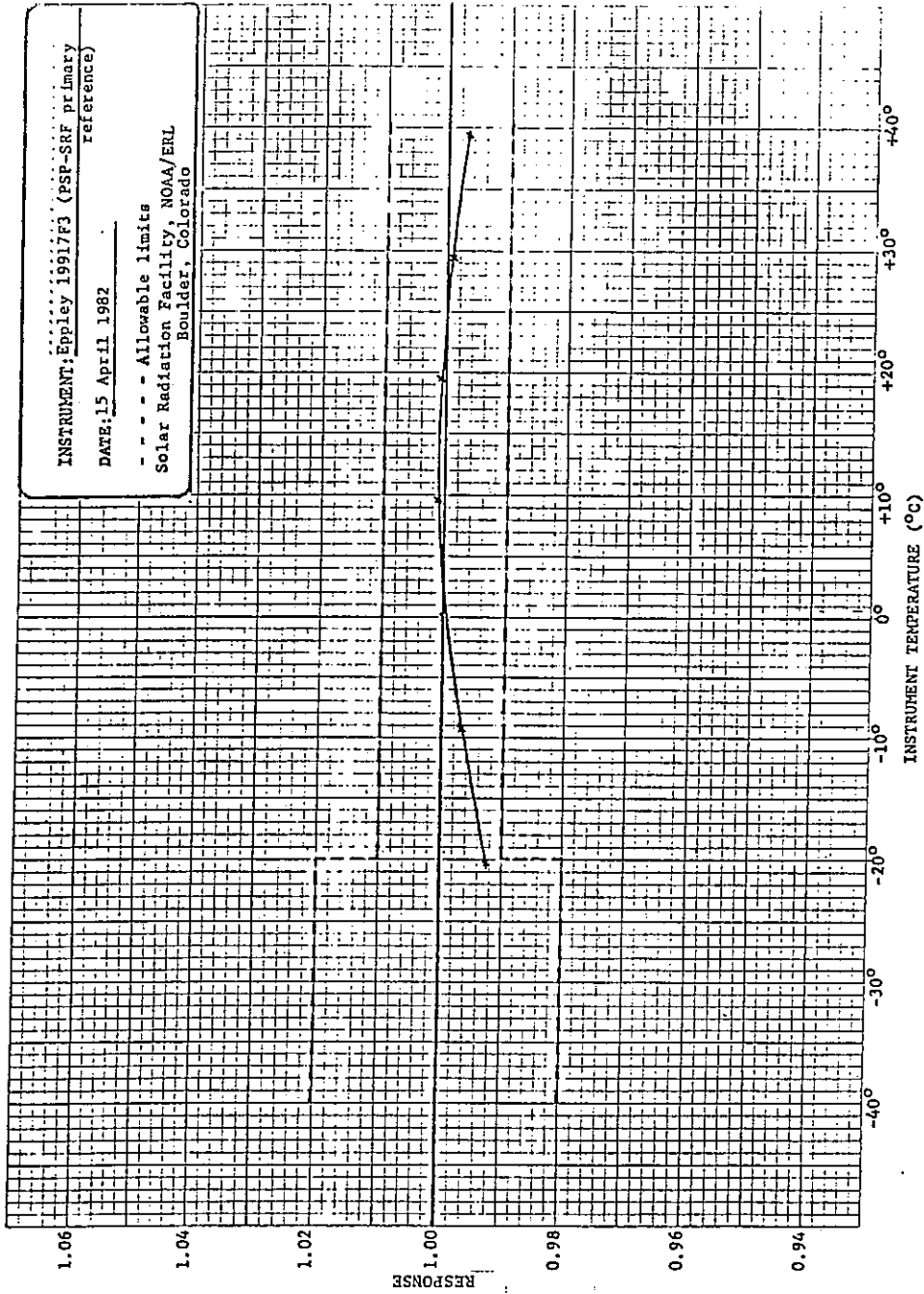
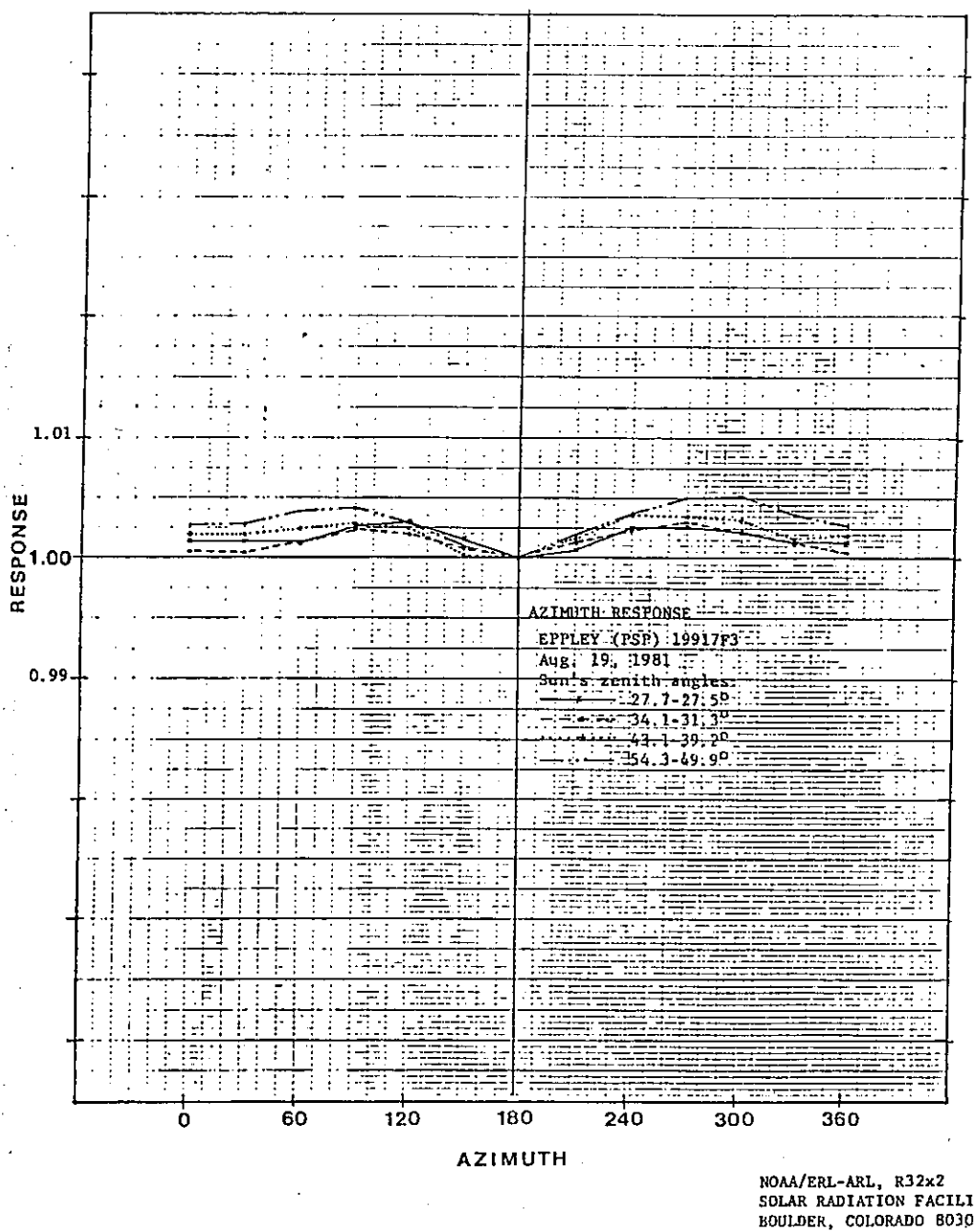

Figure 2: Results of temperature chamber tests of new NOAA/SRF primary reference pyranometer, Eppley PSP s/n 19917F3.



NOAA/ERL-ARL, R32x2
 SOLAR RADIATION FACILI
 BOULDER, COLORADO 8030

Figure 3: Results of outdoor tests of azimuth response for the new NOAA/SRF primary reference pyranometer, Eppley s/n 19917F3. (Compare with Figure 18)

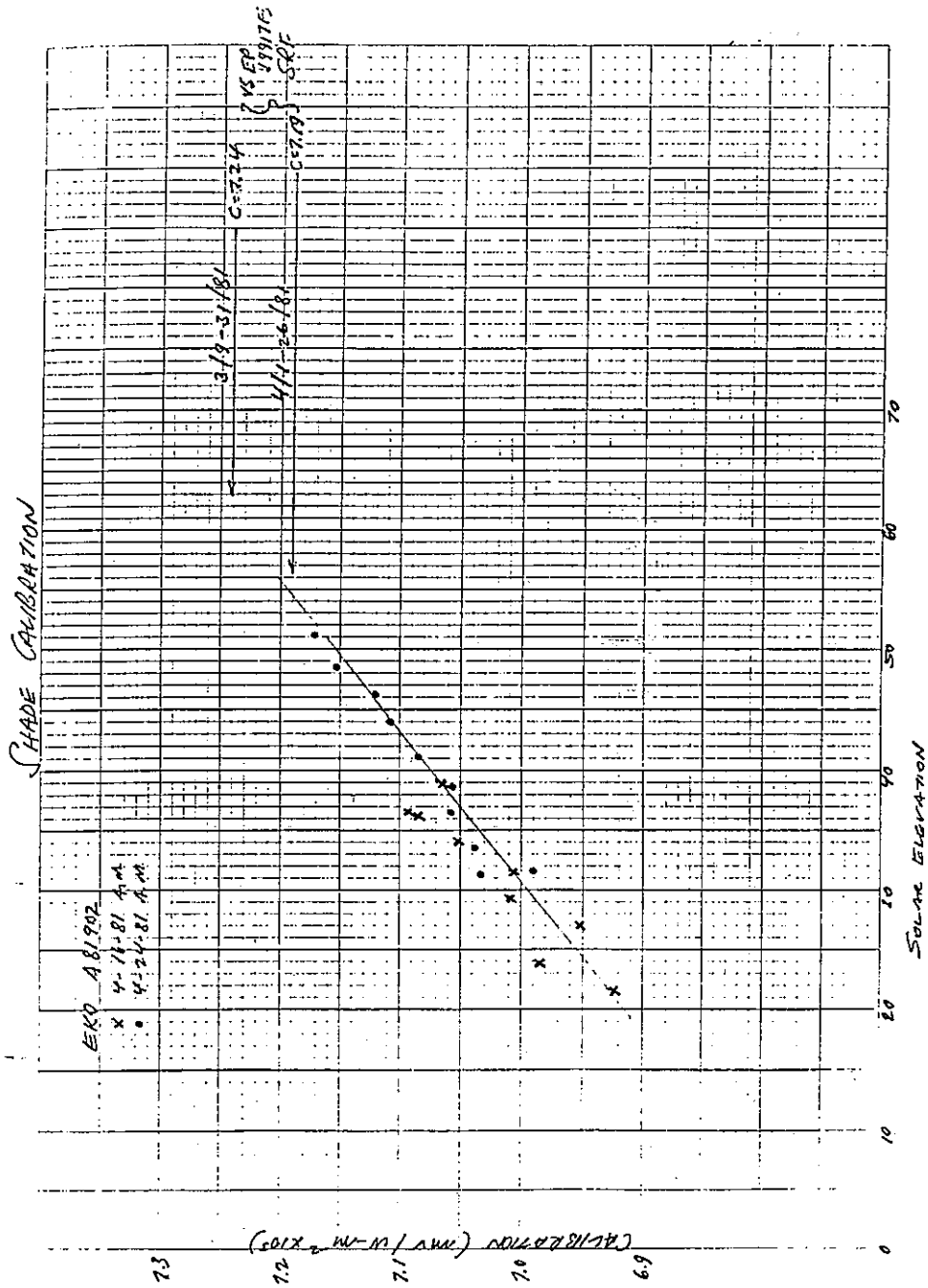

Figure 4: Shade calibration data for EKO A81902 (NOAA/SRF test results).

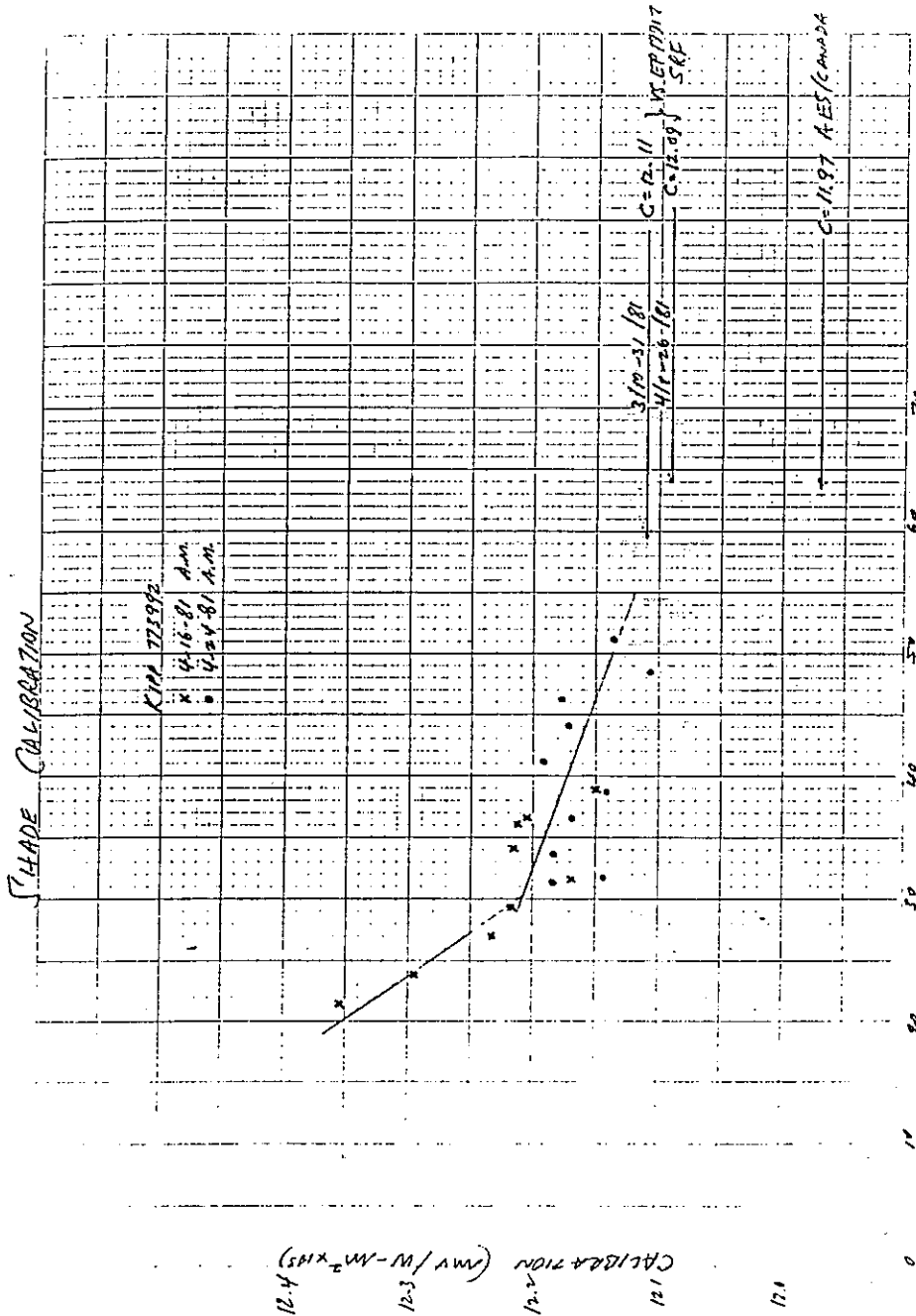

Figure 5: Shade calibration data for KIPP 77-3992 (NOAA/SRF test results).

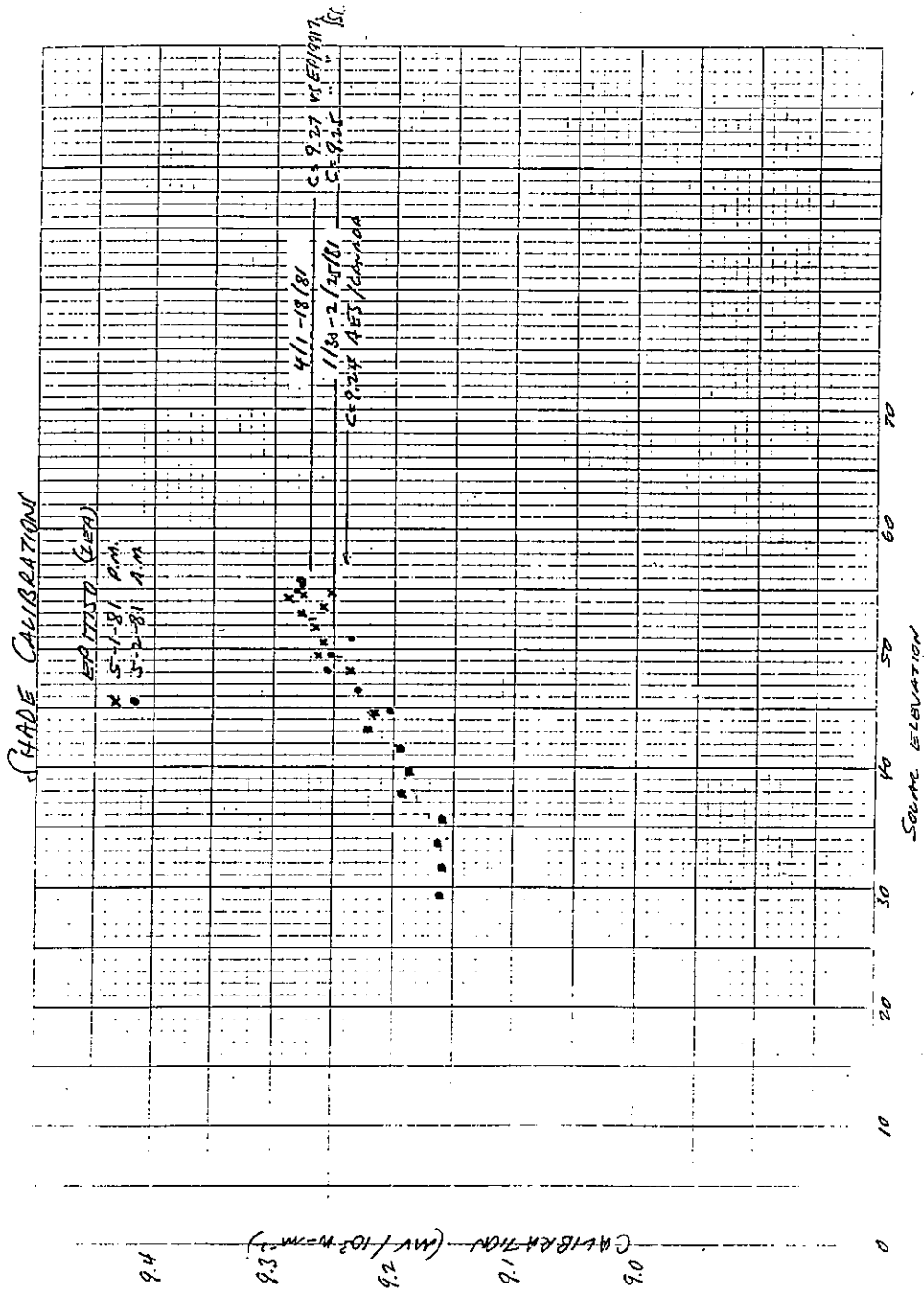

Figure 6: Shade calibration data for Eppley PSP 17750 (NOAA/SRF test results).

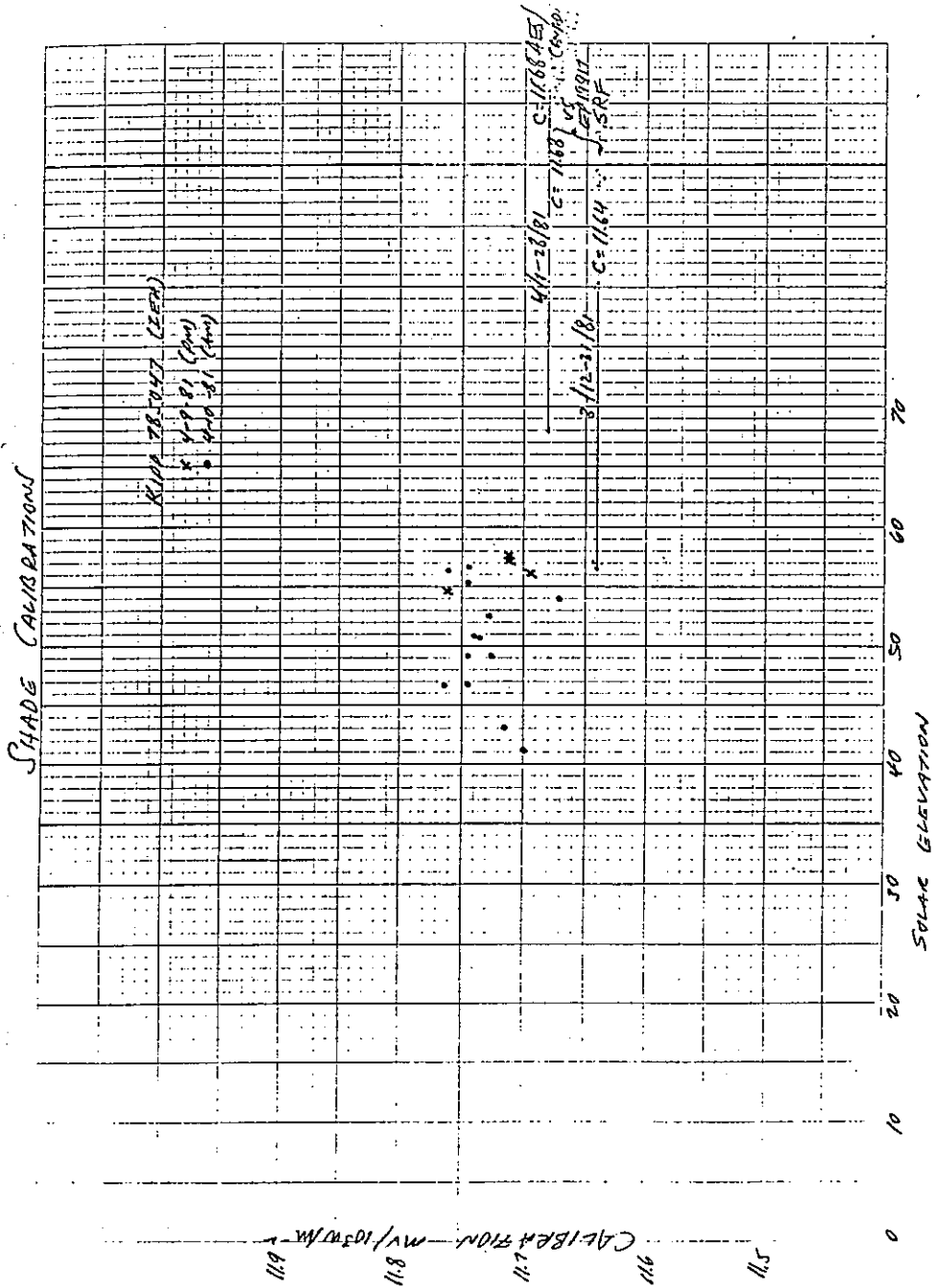

Figure 7: Shade calibration data for KIPP 78-5047 (NOAA/SRF test results).

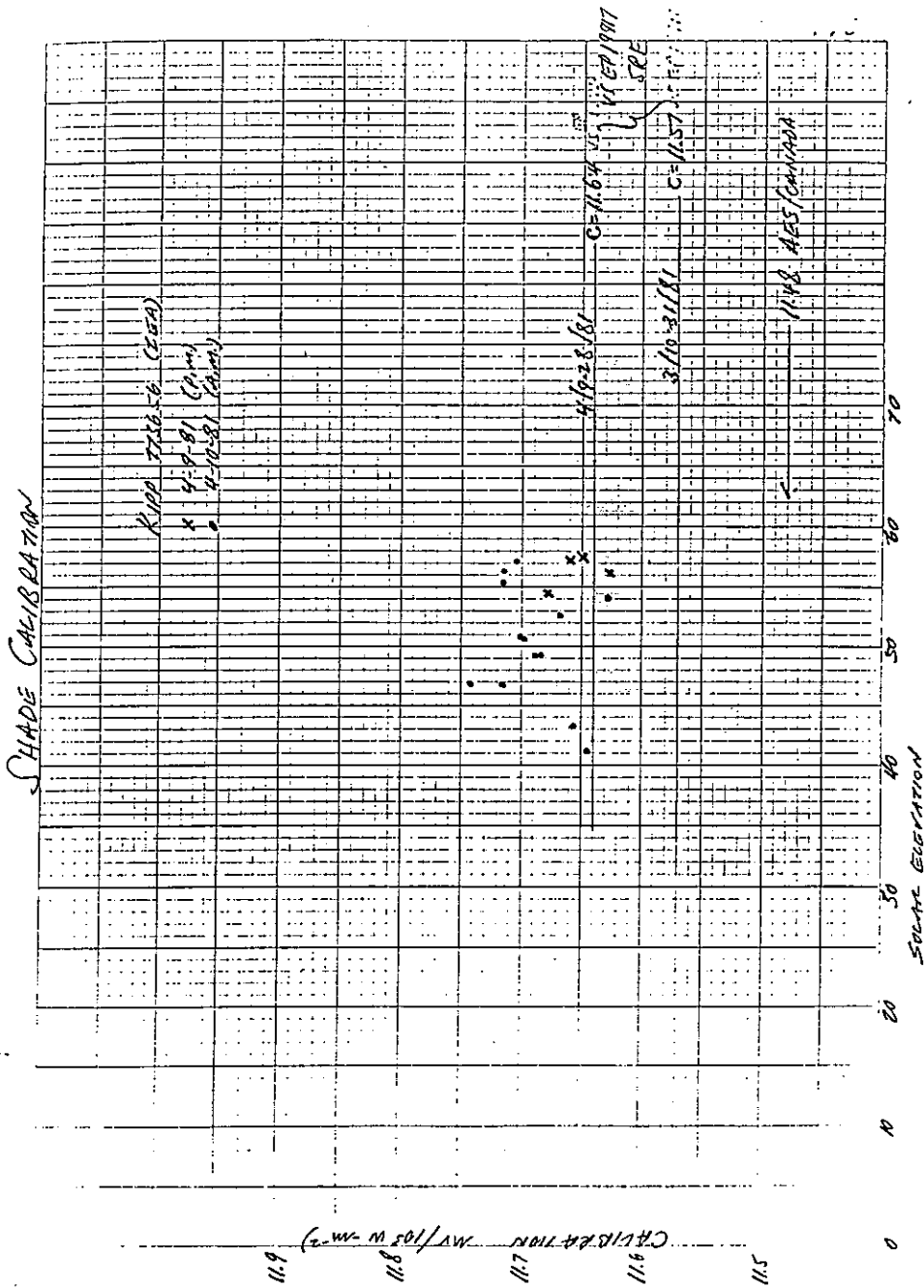

Figure 8: Shade calibration data for KIPP 77-3656 (NOAA/SRF test results).

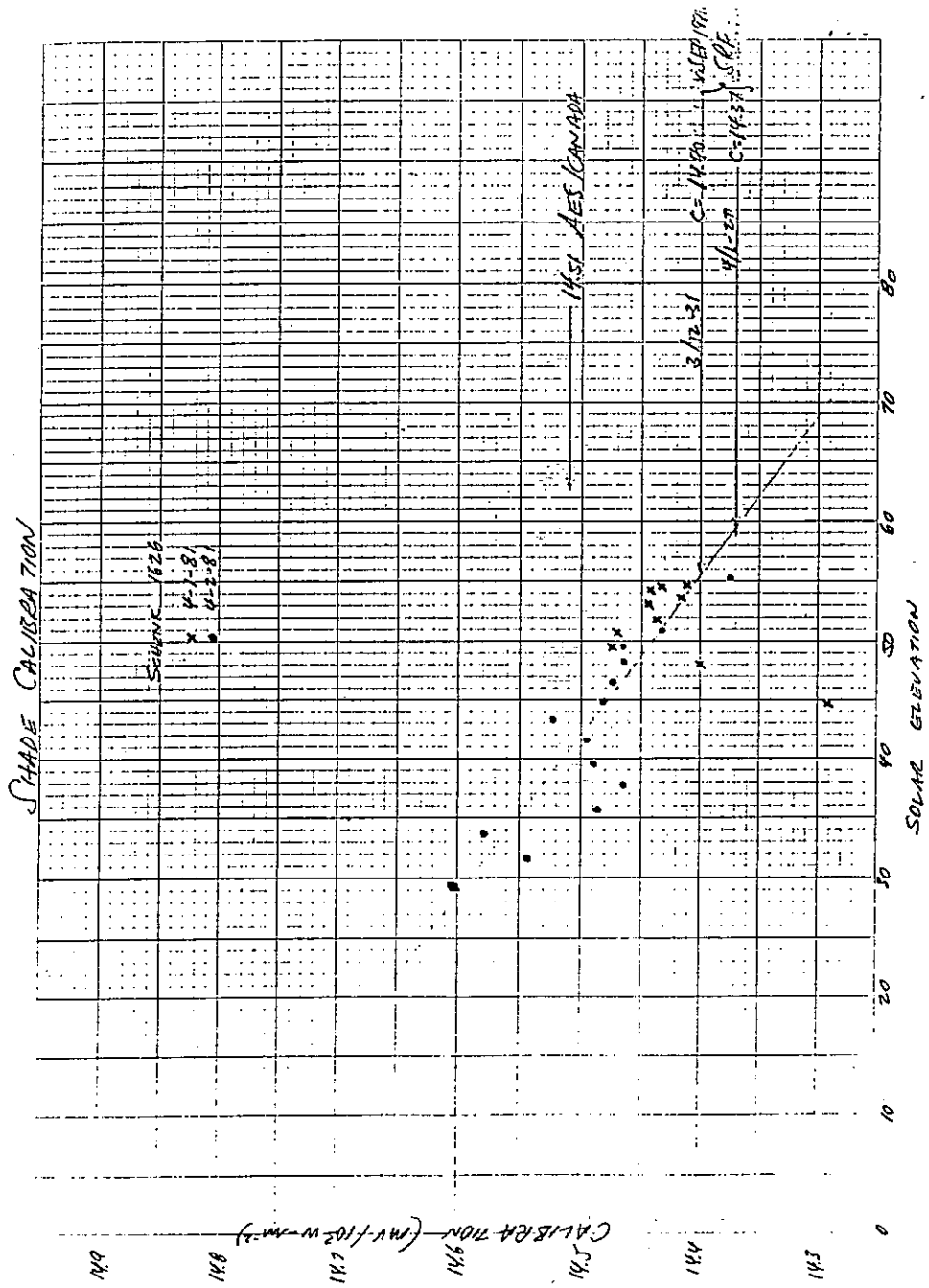

Figure 9: Shade calibration data for SCHENK 1626 (NOAA/SRF test results).

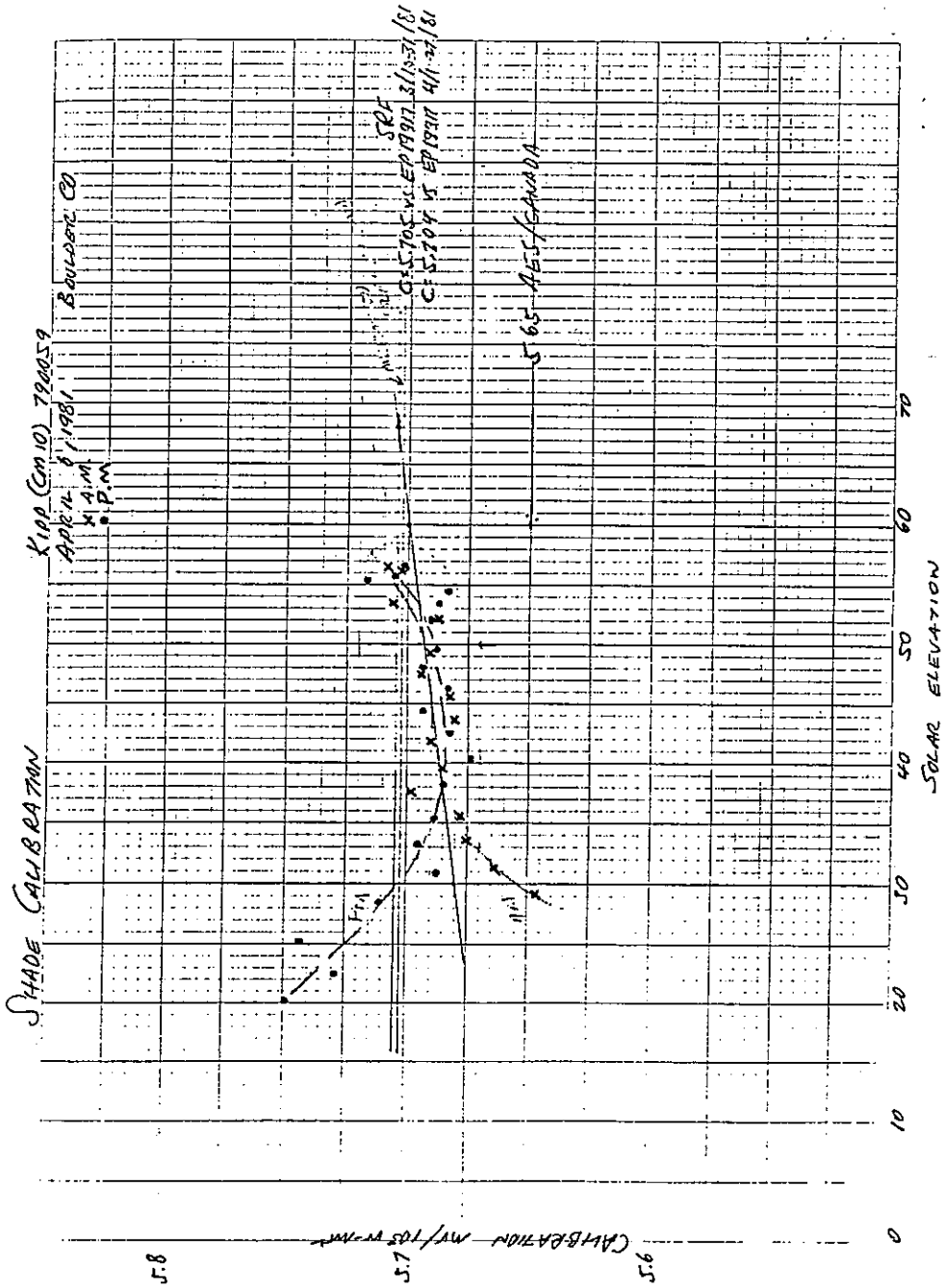

Figure 10: Shade calibration data for KIPP (CM-10) 79-0059 (NOAA/SRF test results).

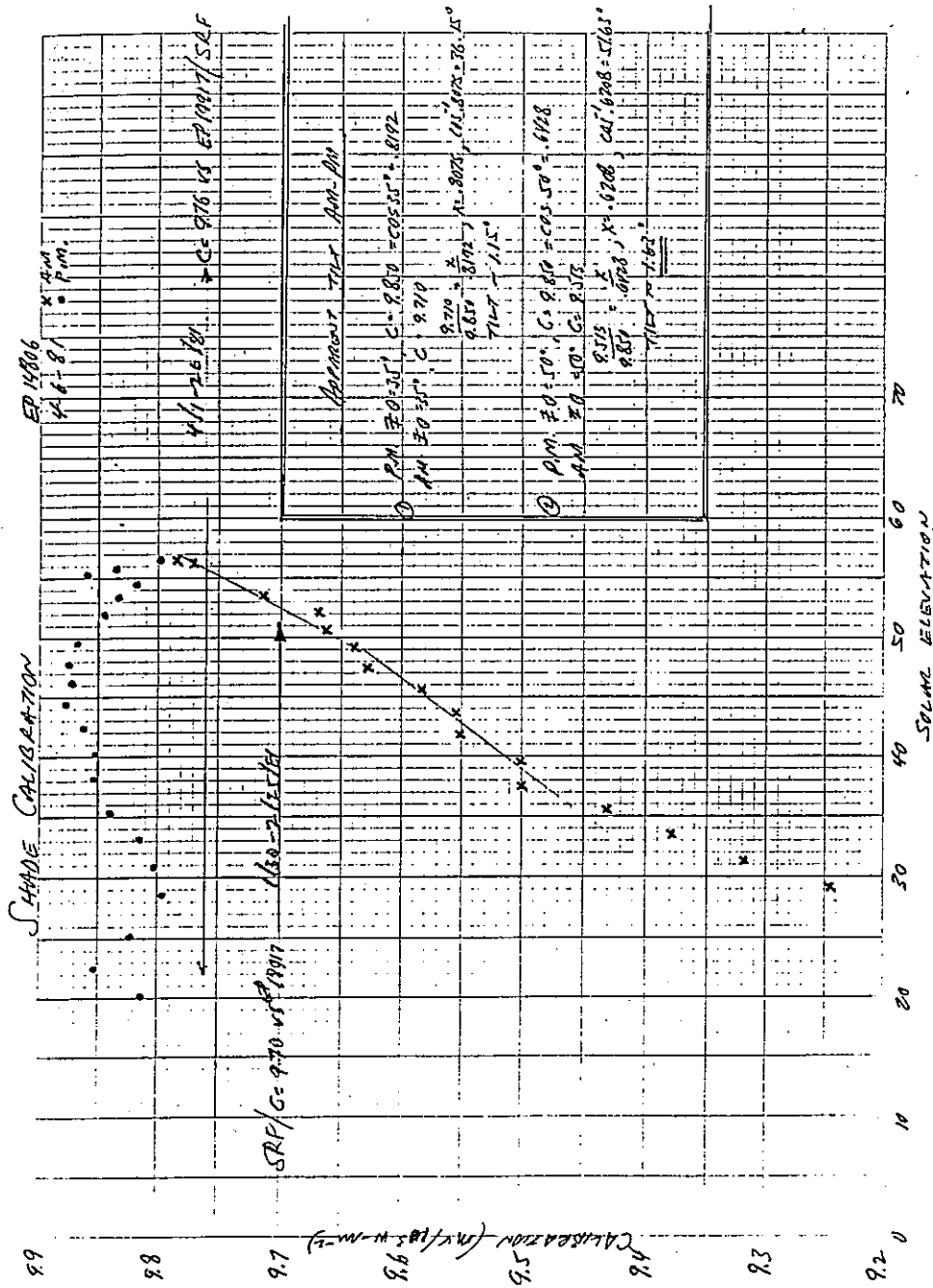

Figure 11: Shade calibration data for Eppley PSP 14806F3 (NOAA/SRF test results).

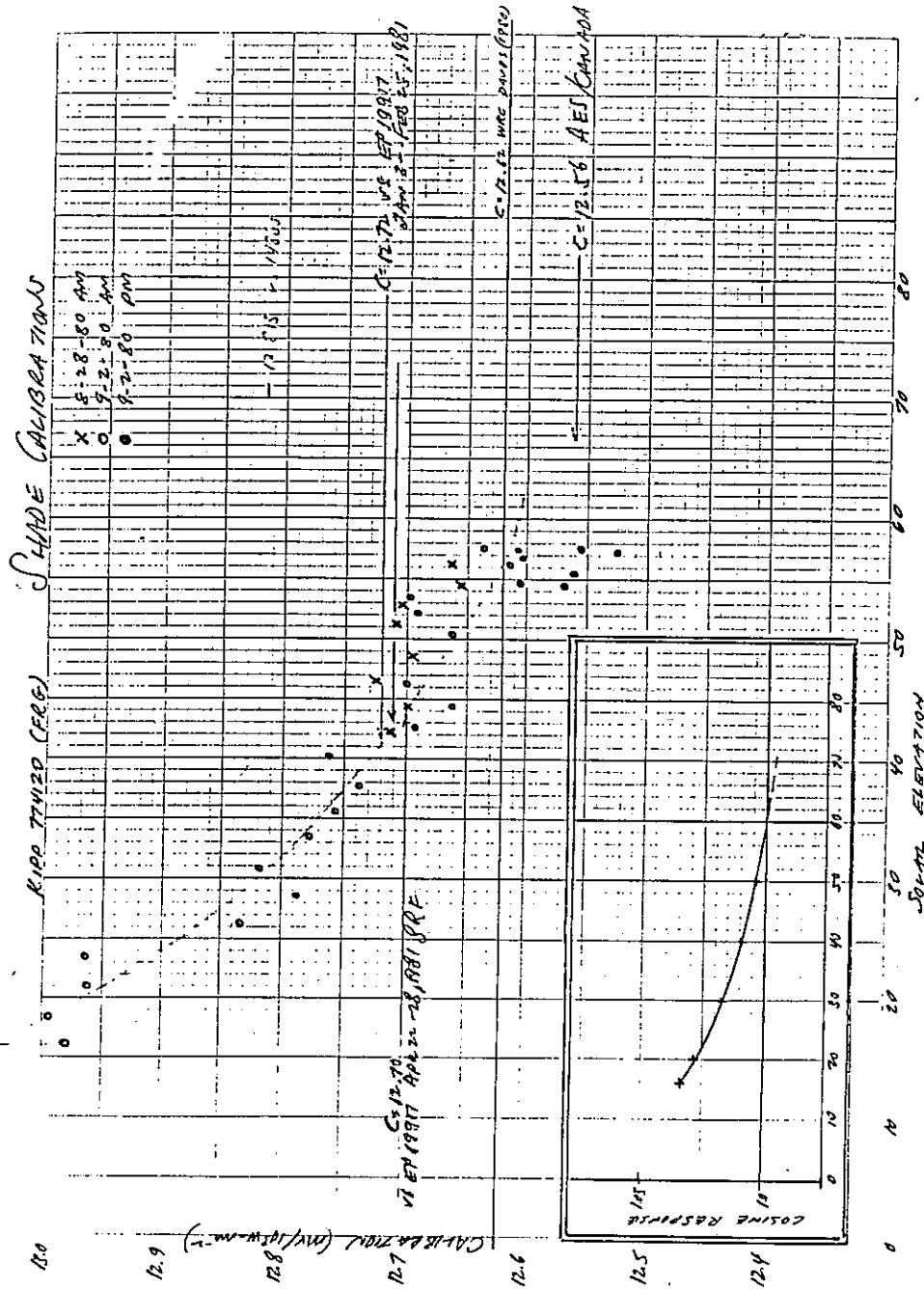
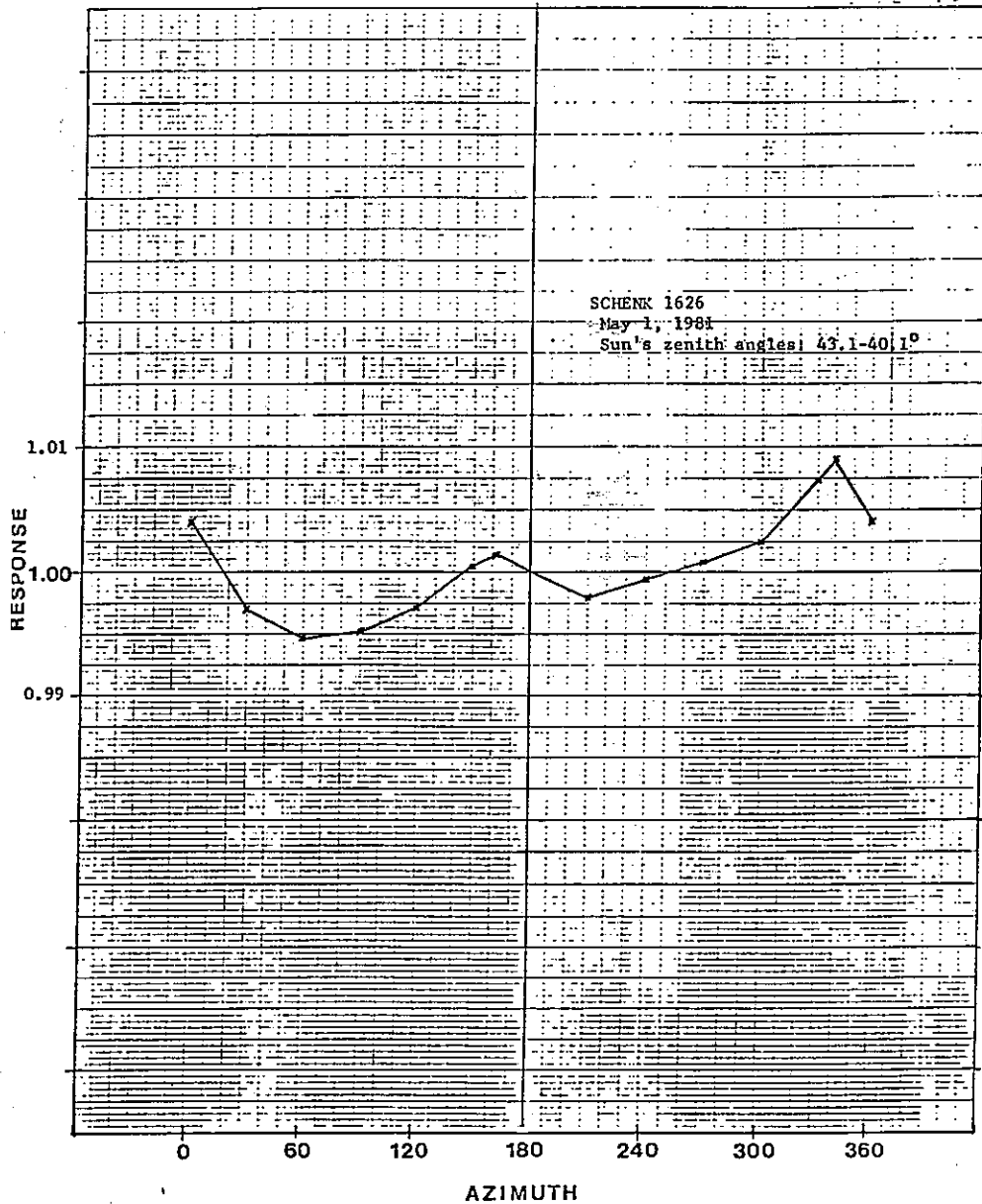
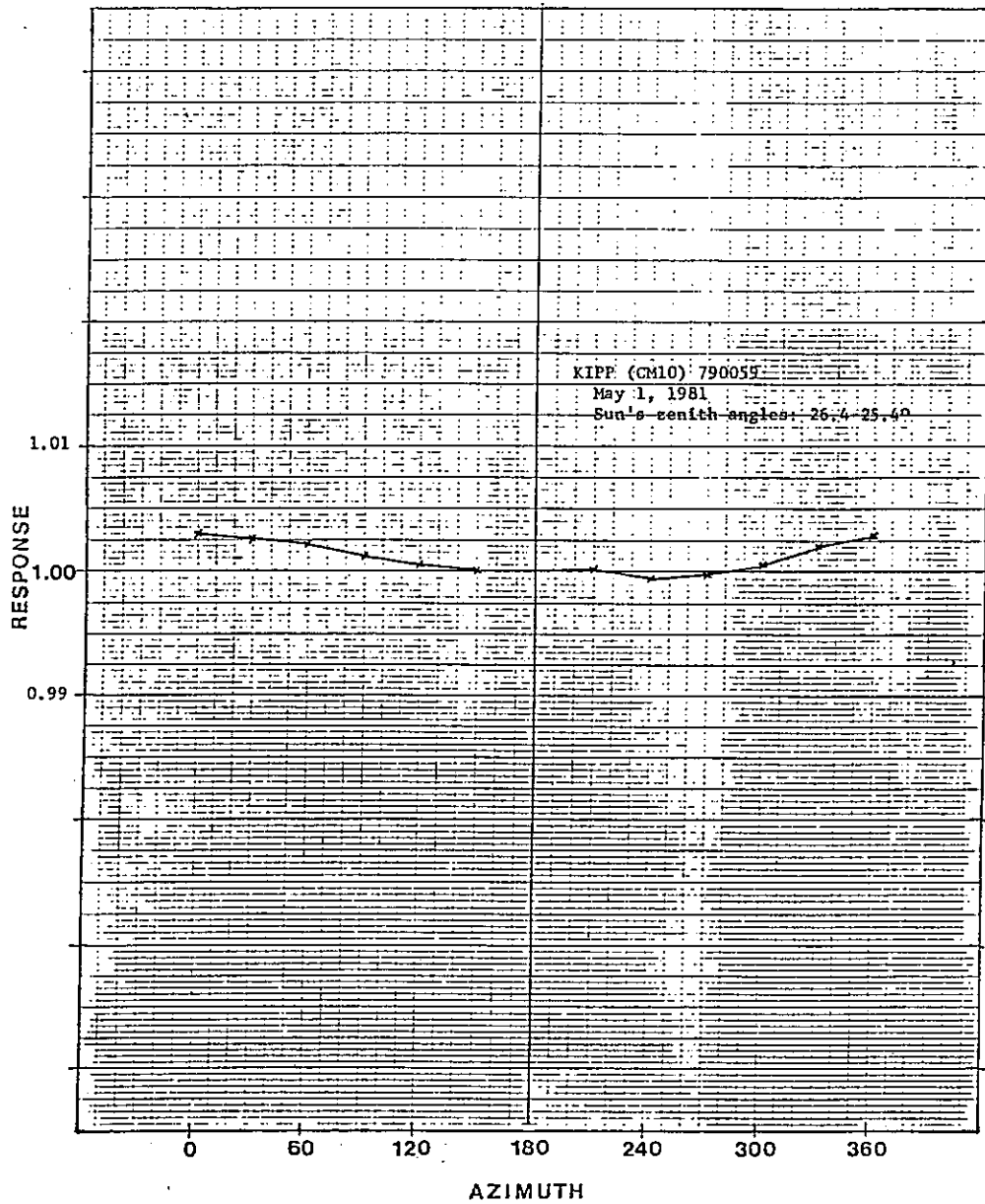

Figure 12: Shade calibration data for KIPP 77-4120 (NOAA/SRF test results).



NOAA/ERL-ARL, R32x2
 SOLAR RADIATION FACILITY
 BOULDER, COLORADO 80303

Figure 13: Outdoor test of azimuth response for Schenk 1626.



NOAA/ERL-ARL, R32x2
 SOLAR RADIATION FACILITY
 BOULDER, COLORADO 80303

Figure 14: Outdoor test of azimuth response for KIPP (CM-10) 79-0059.

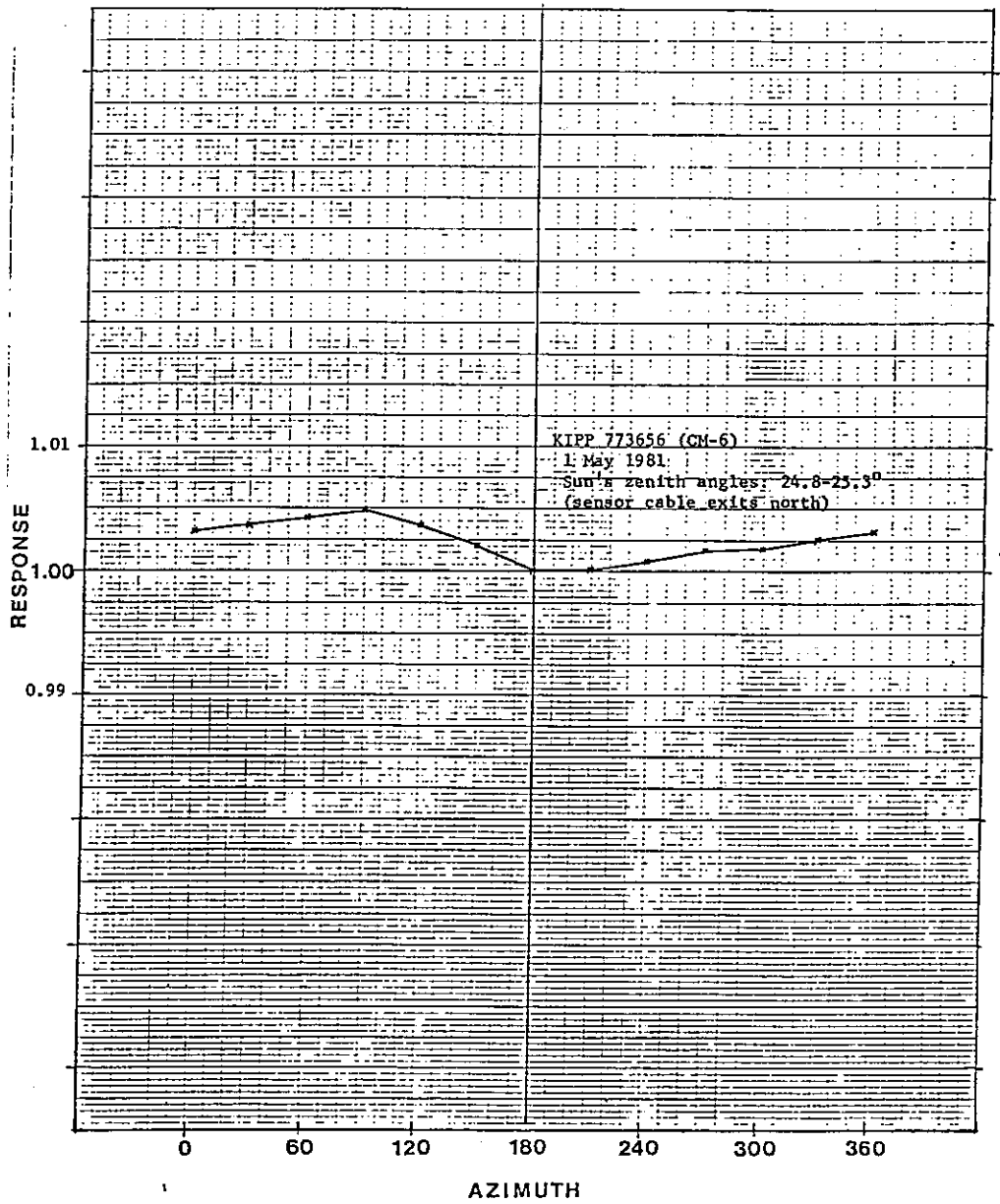

NOAA/ERL-ARL, R32x2
 SOLAR RADIATION FACILITY
 BOULDER, COLORADO 8030

Figure 15: Outdoor test of azimuth response for KIPP (CM-6) 77-3656.

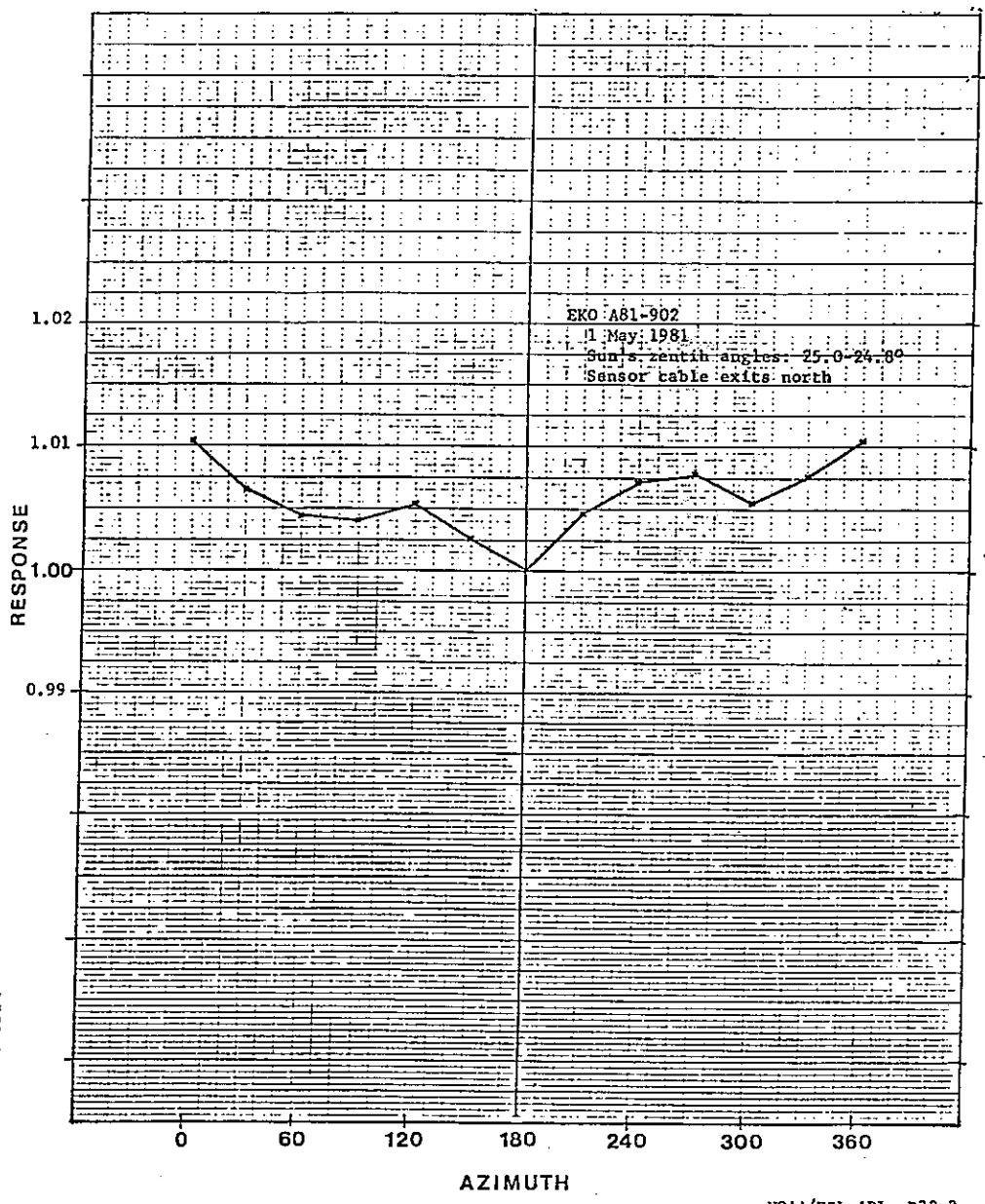

NOAA/ERL-ARL, R32x2
 SOLAR RADIATION FACILI
 BOULDER, COLORADO 8030

Figure 16: Outdoor test of azimuth response for EKO A81-902.

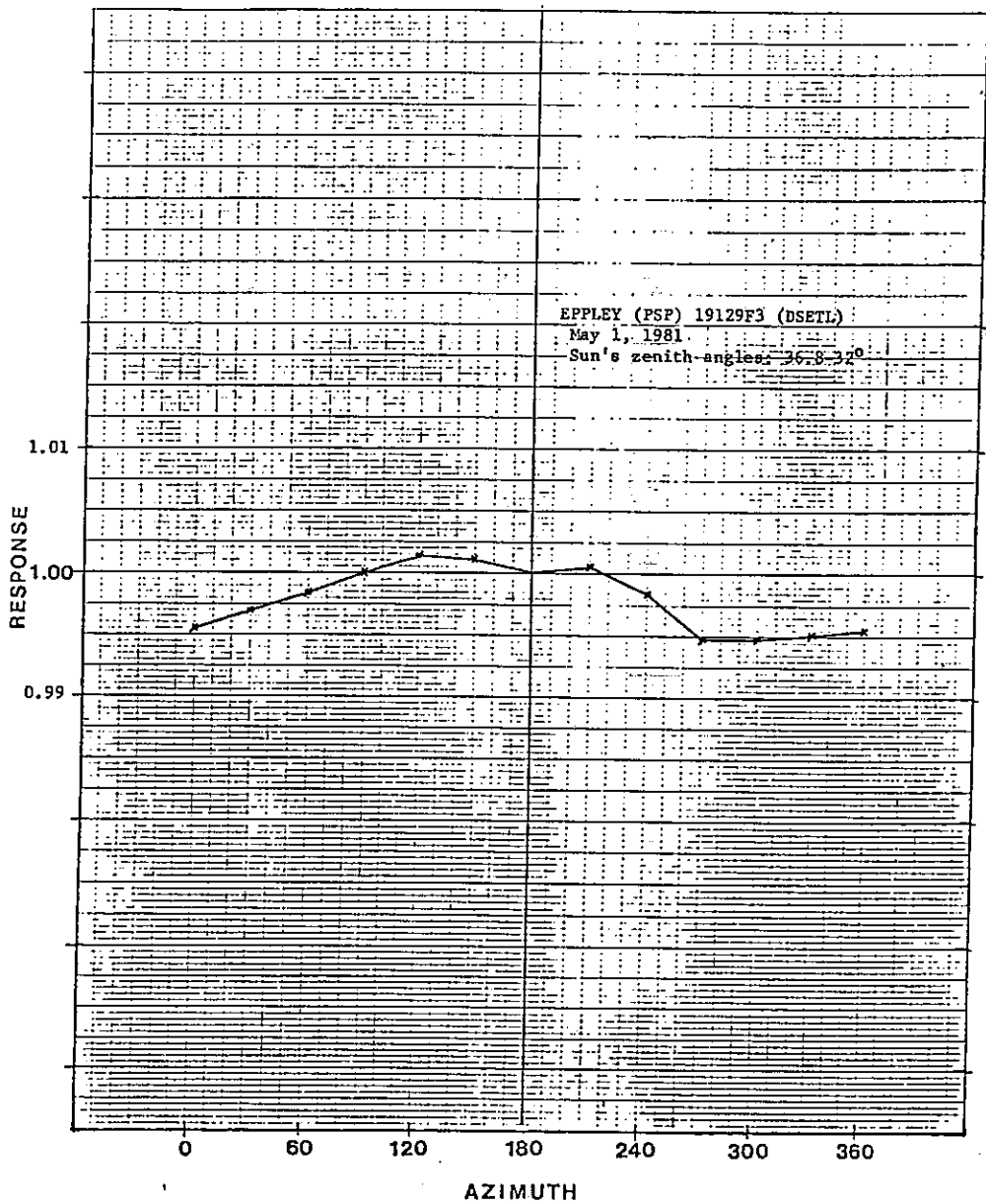

NOAA/ERL-ARL, R32x2
 SOLAR RADIATION FACILITY
 BOULDER, COLORADO 80305

Figure 17: Outdoor test of azimuth response for Eppley PSP 19129F3.

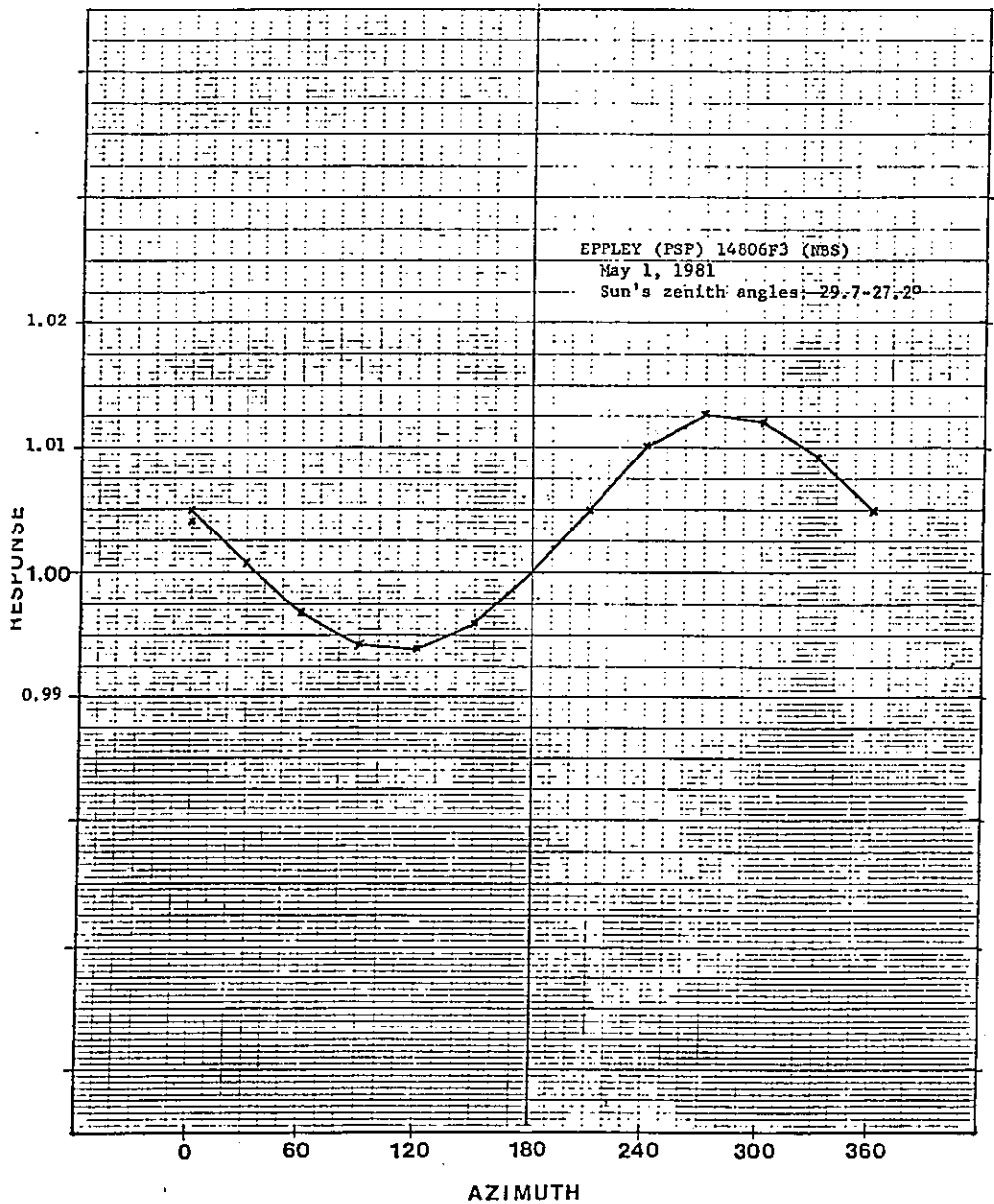

NOAA/ERL-ARL, R32x2
 SOLAR RADIATION FACILITY
 BOULDER, COLORADO 80303

Figure 18: Outdoor test of azimuth response for Eppley PSP 14806F3.

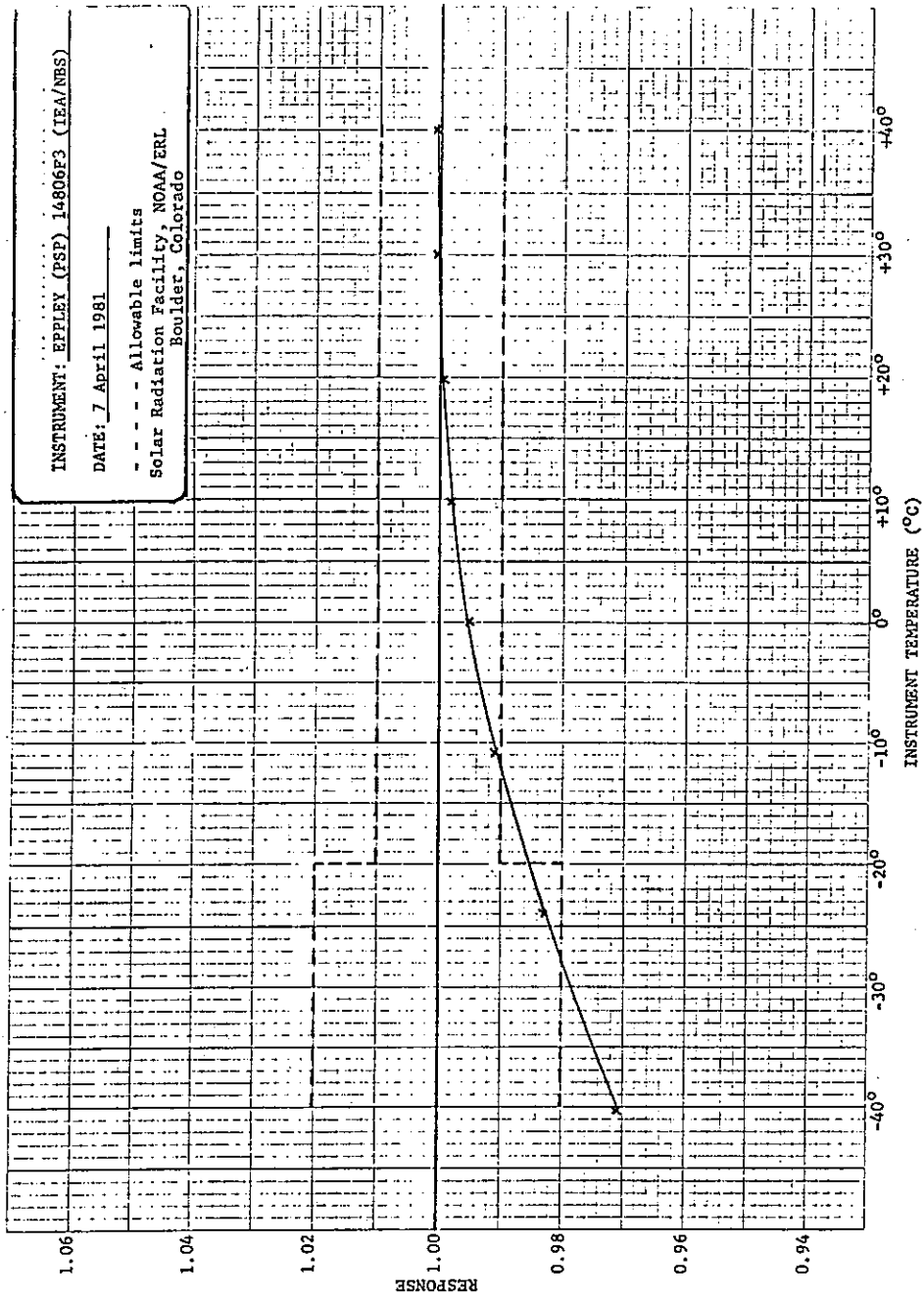

Figure 19: Temperature chamber test data for Eppley PSP 14806F3.

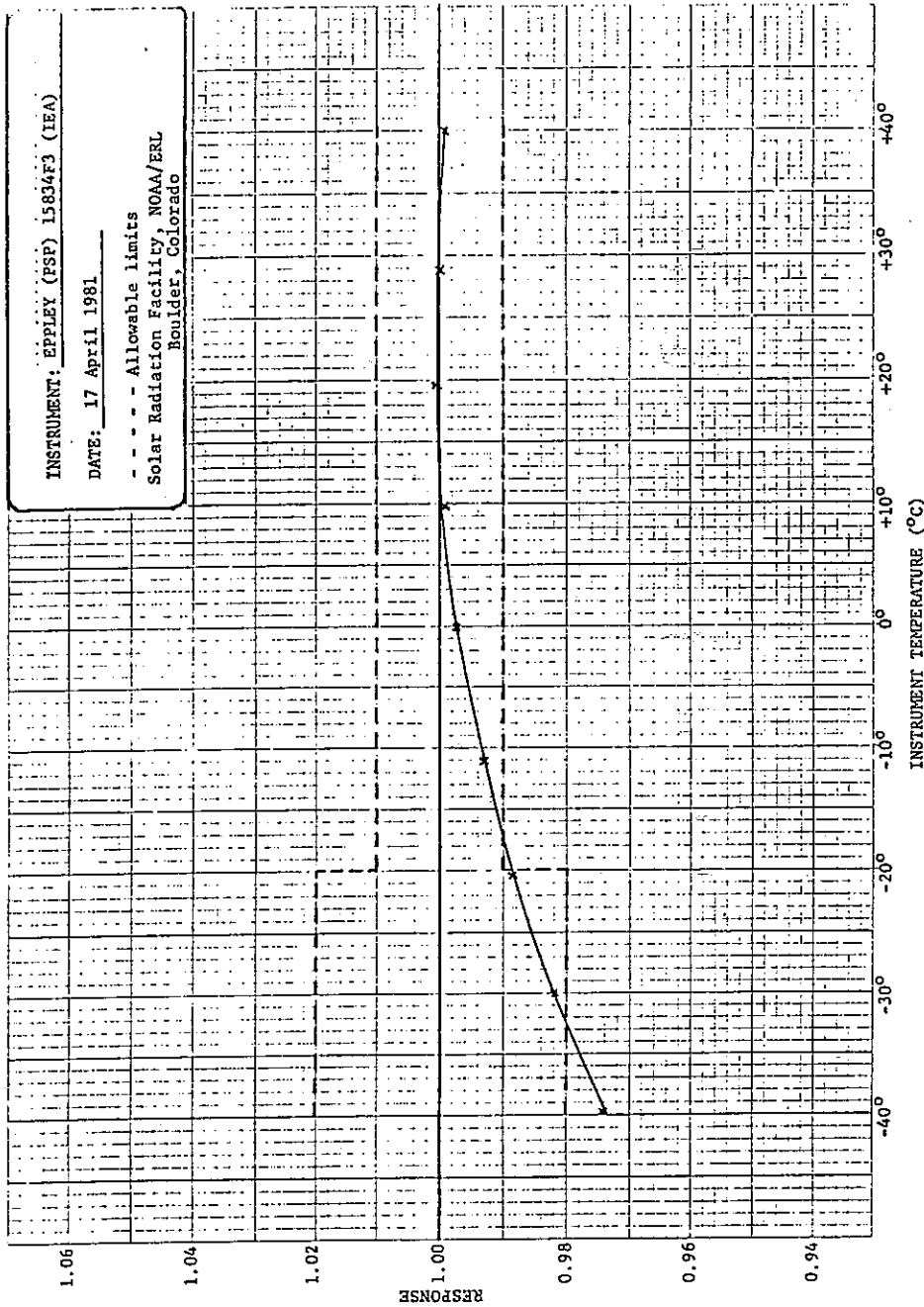

Figure 20: Temperature chamber test data for Eppley PSP 15834F3.

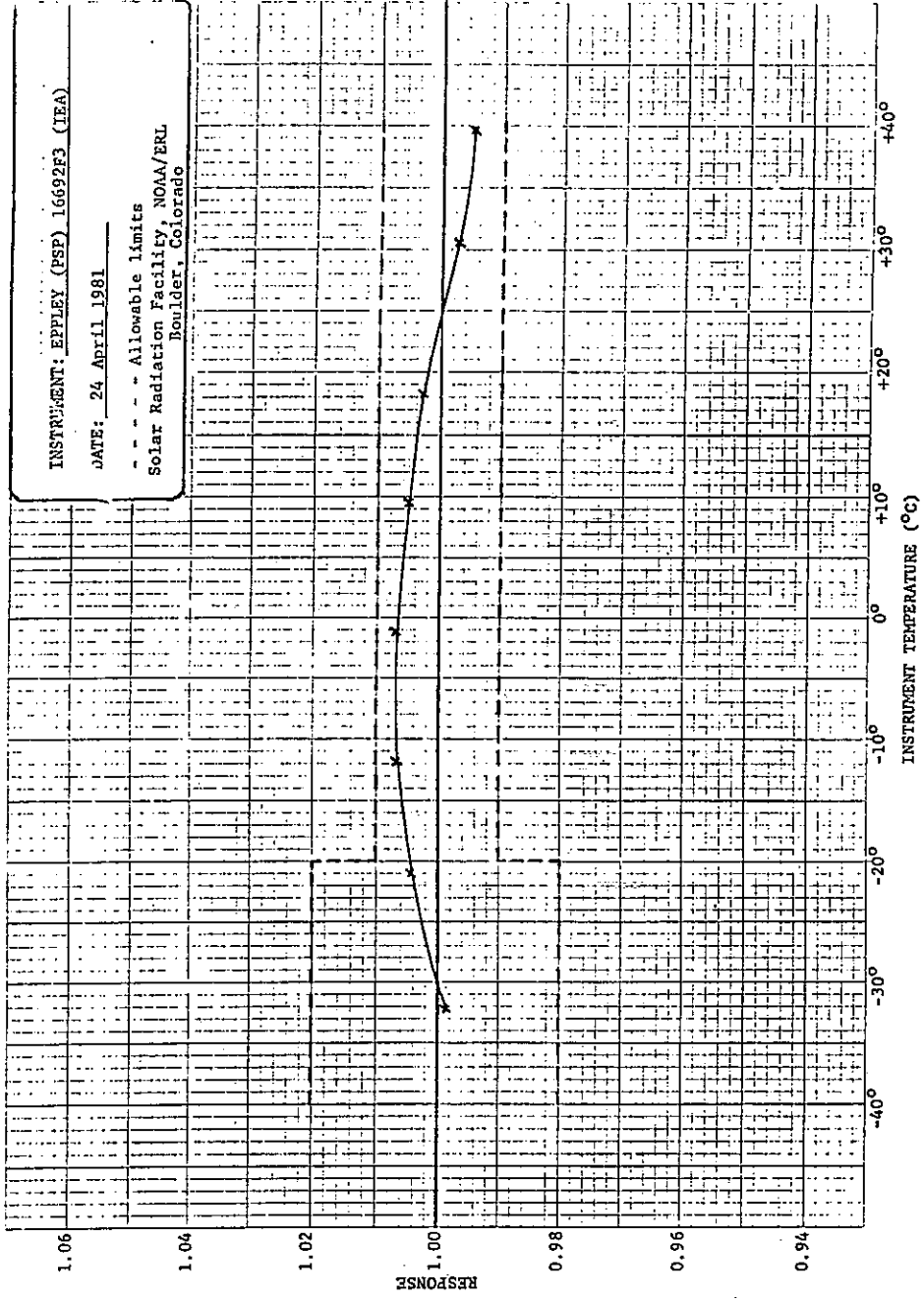

Figure 21: Temperature chamber test data for Eppley PSP 16692F3.

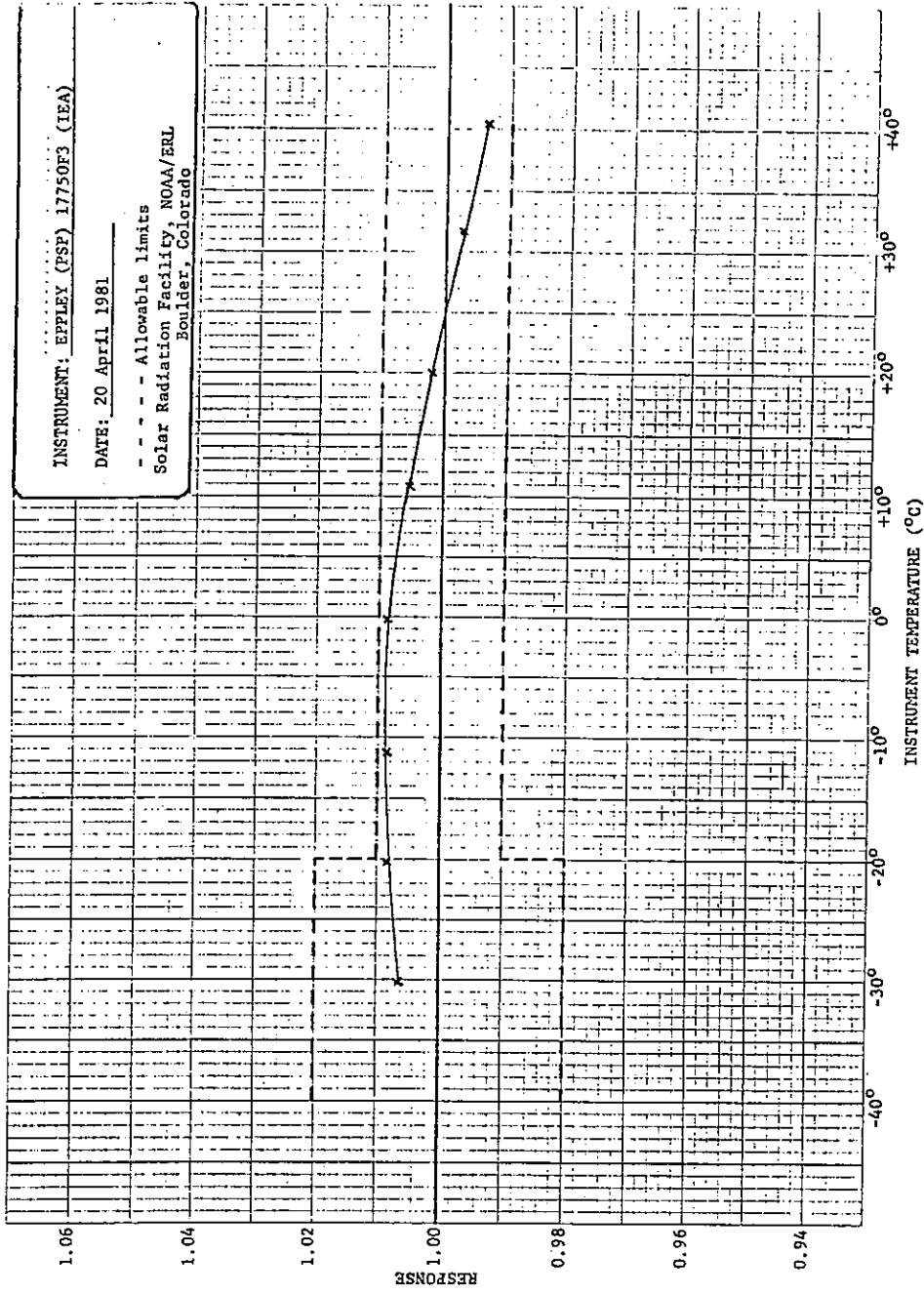
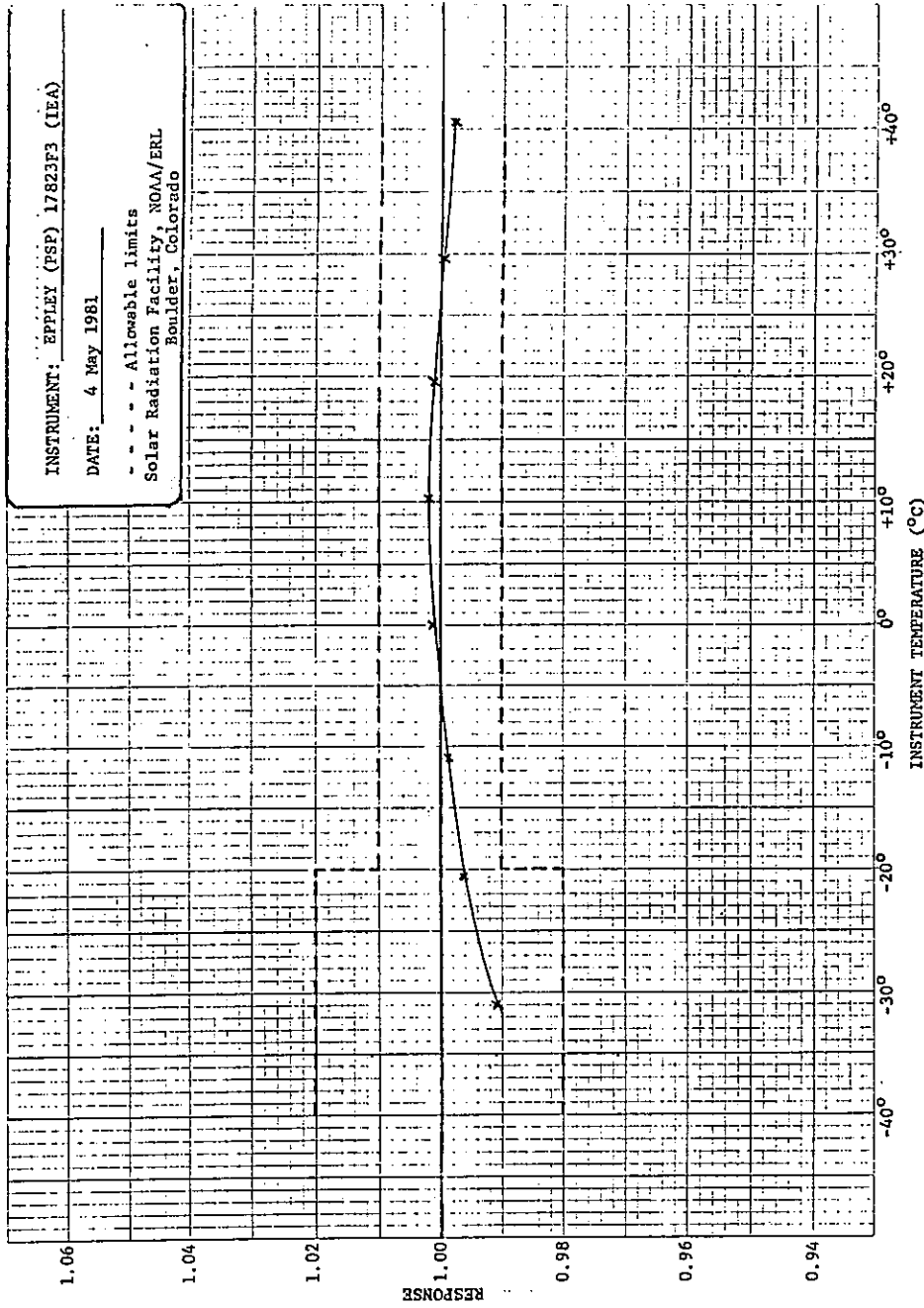

Figure 22: Temperature chamber test data for Eppley PSP 17750F3.



1727

Figure 23: Temperature chamber test data for Eppley PSP 17823F3.

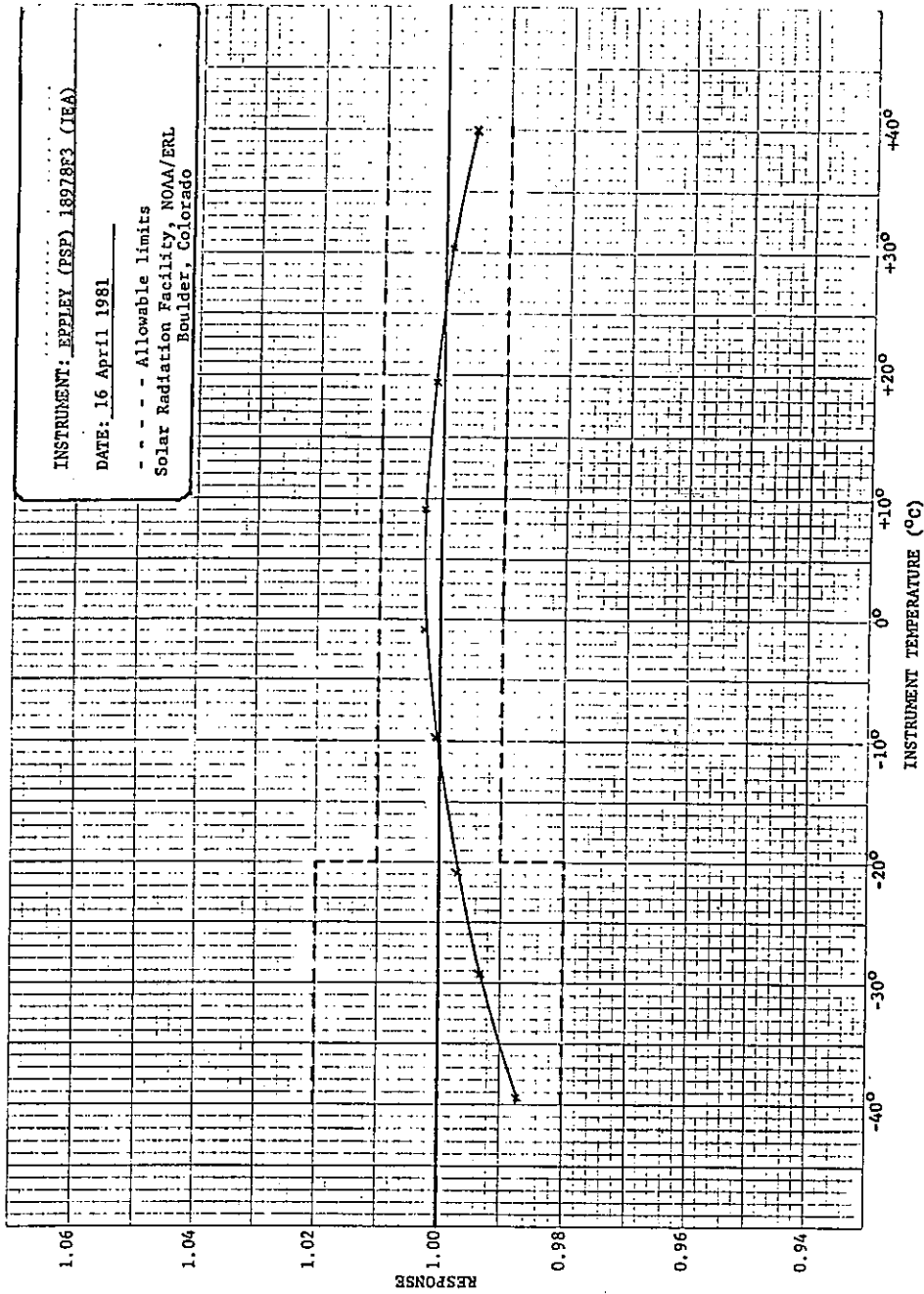

Figure 24: Temperature chamber test data for Eppley PSP 18978F3.

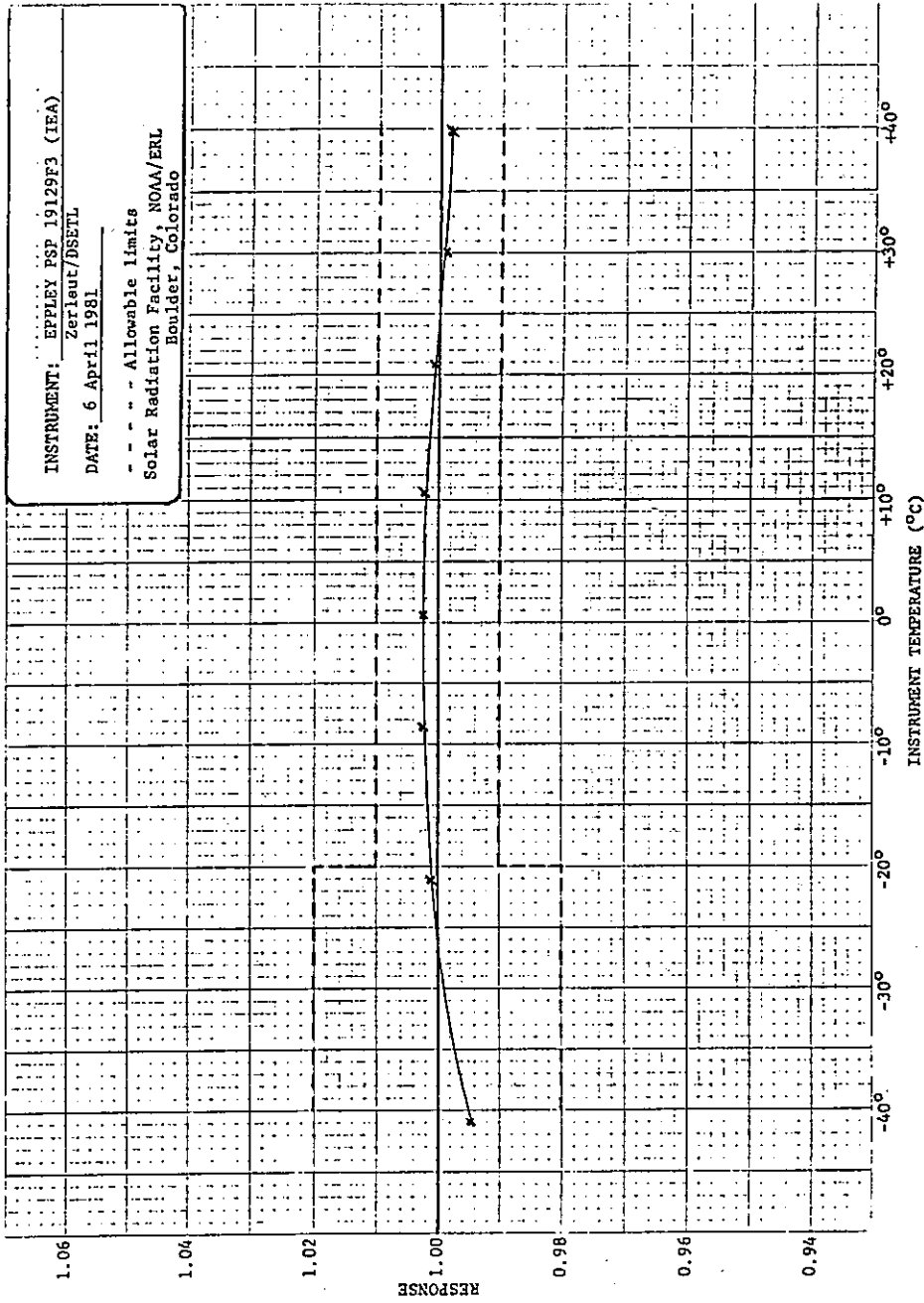

Figure 25: Temperature chamber test data for Eppley PSP 19129F3.

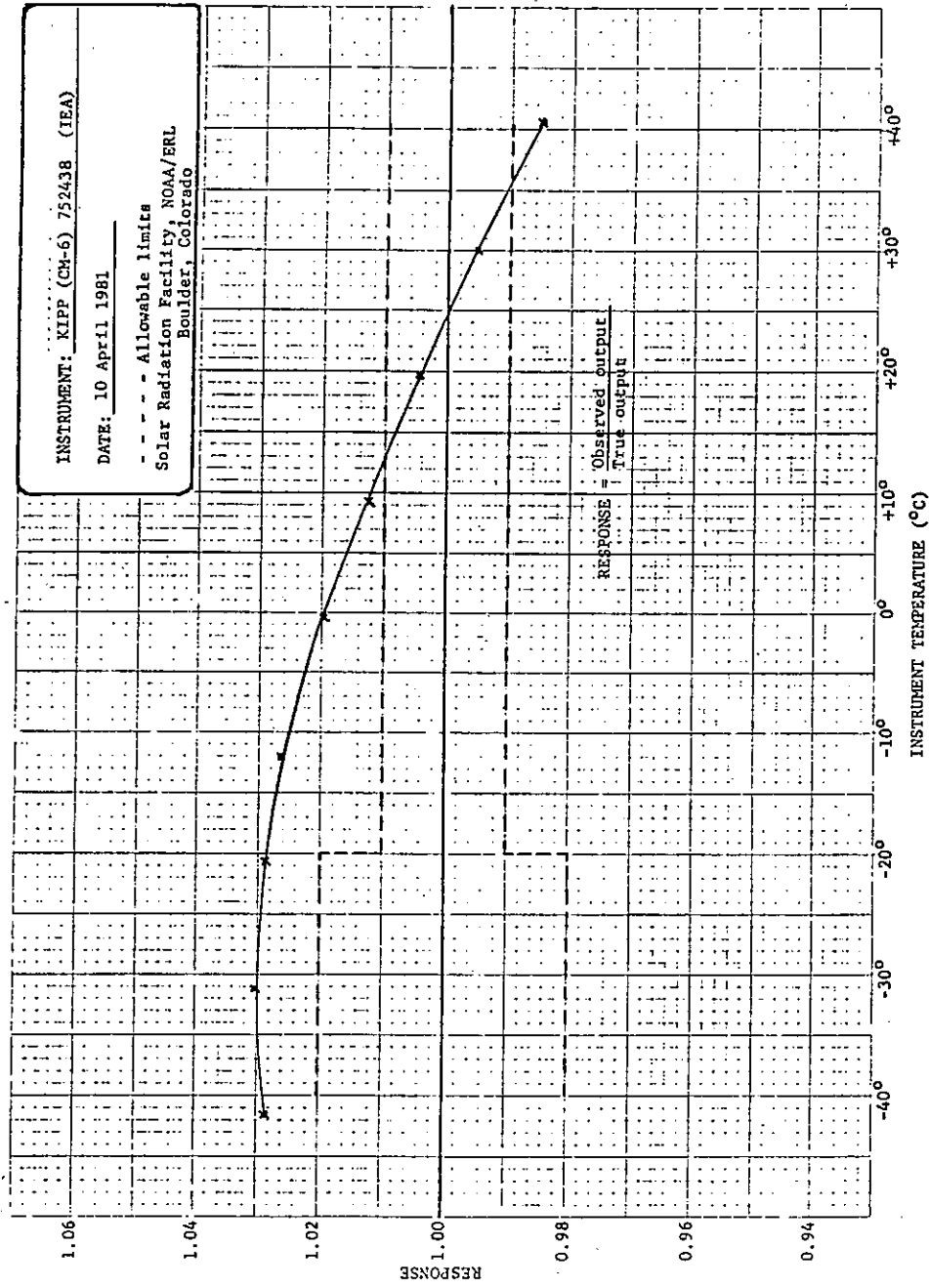

Figure 26: Temperature chamber test data for KIPP (CM-6) 75-2438.

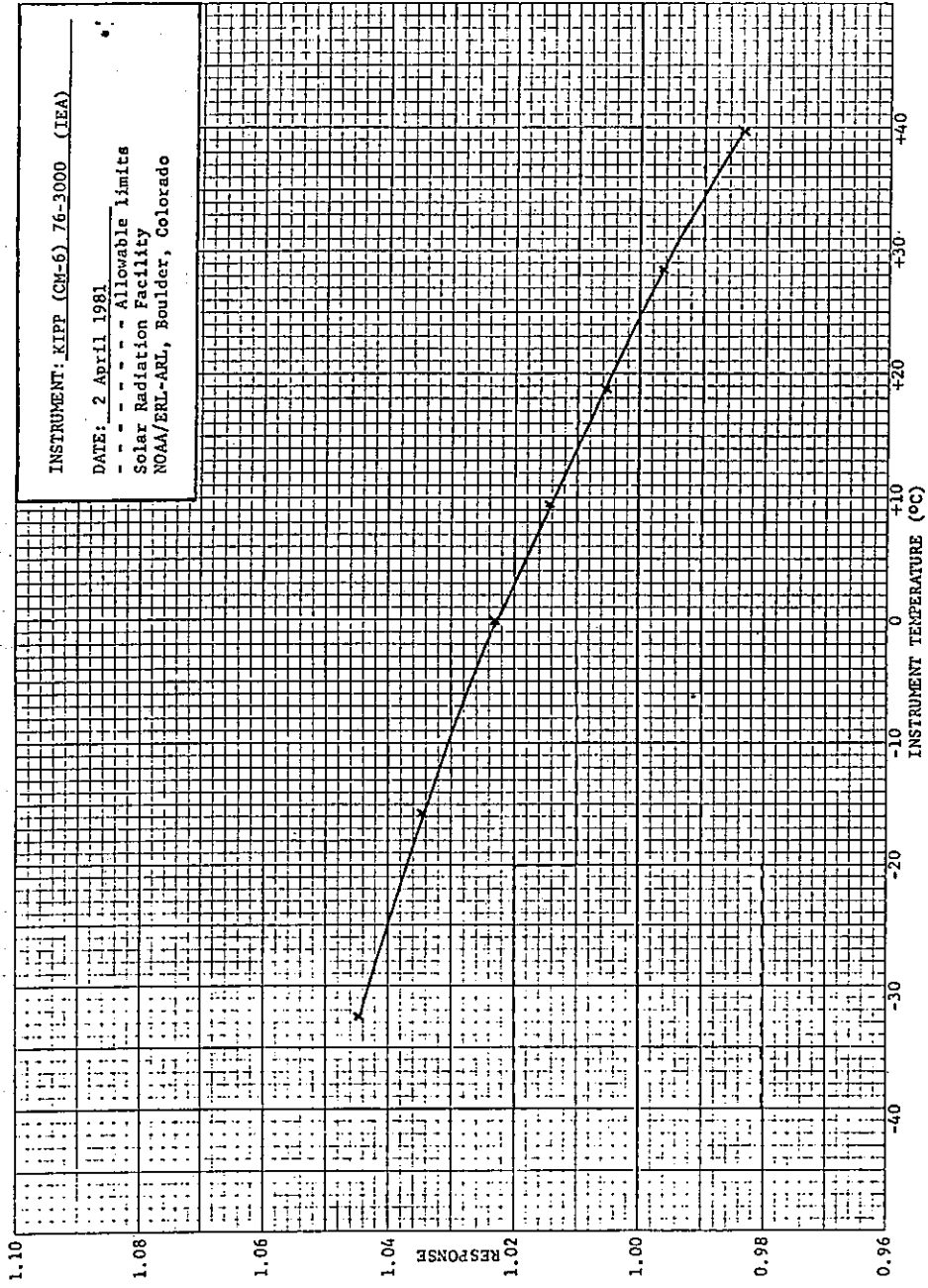

Figure 27: Temperature chamber test data for KIPP (CM-6) 76-3000.

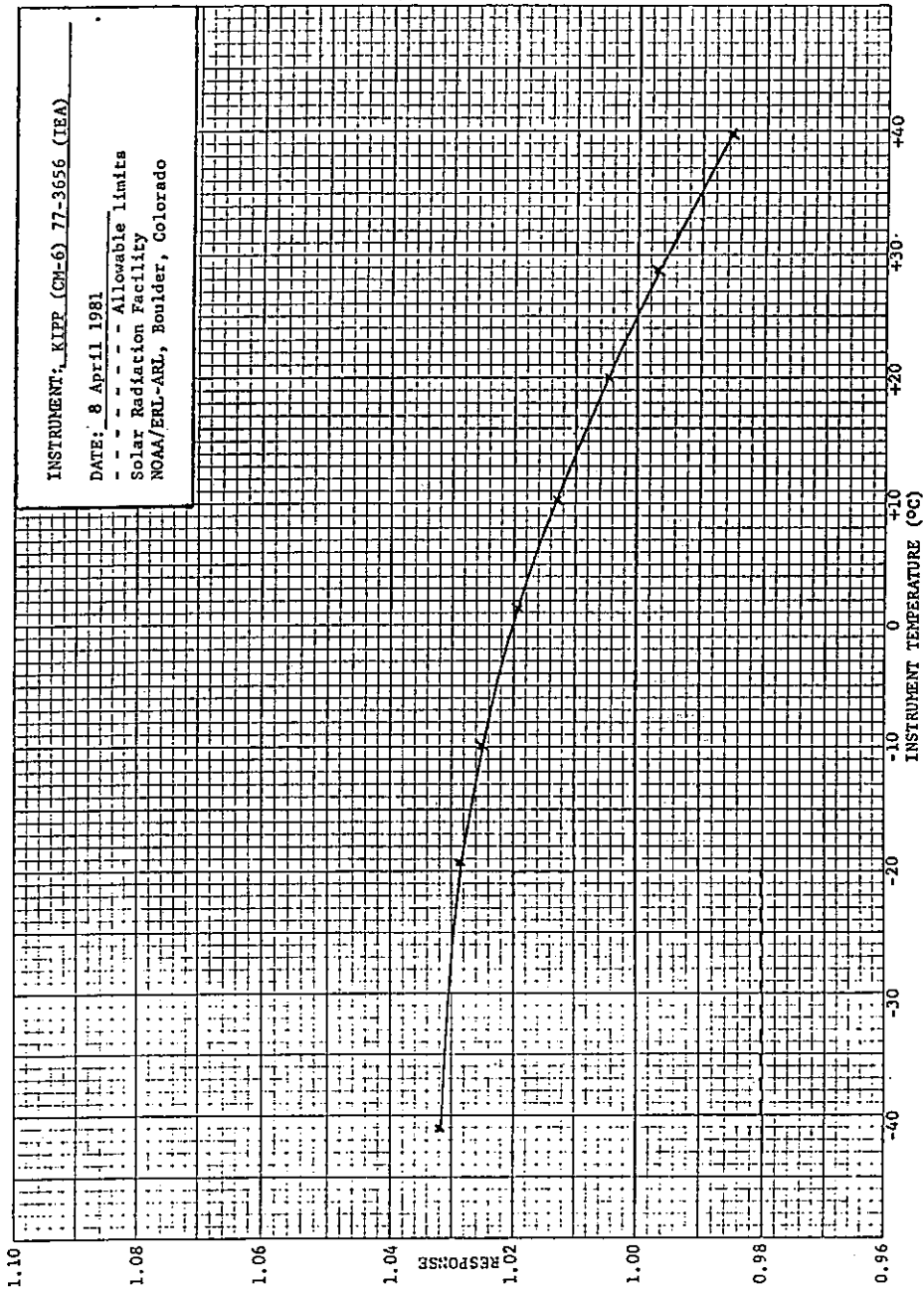

Figure 28: Temperature chamber test data for Kipp & Zonen (CM-6) 77-3656.

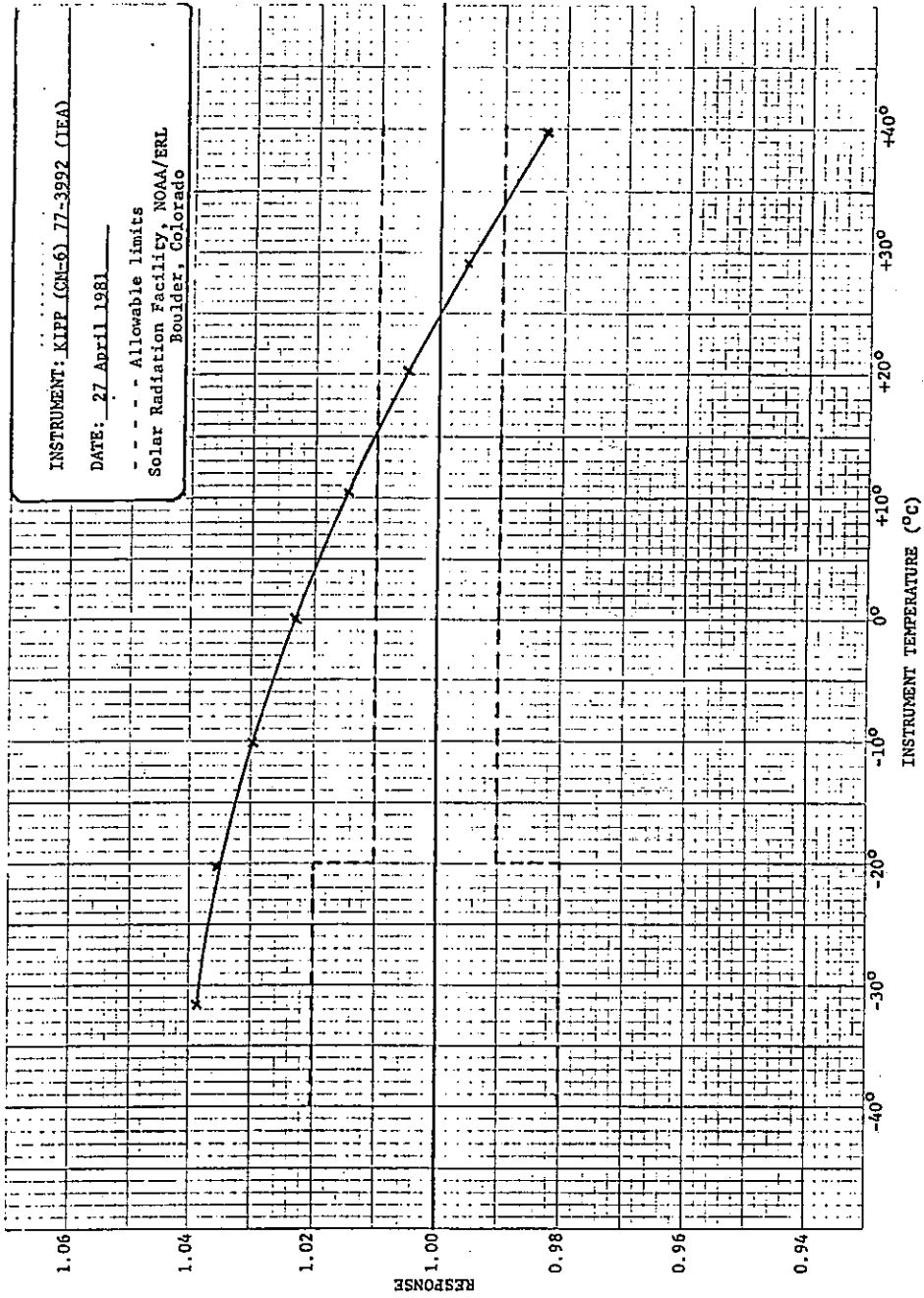

Figure 29: Temperature chamber test data for Kipp & Zonen (CM-6) 77-3992.

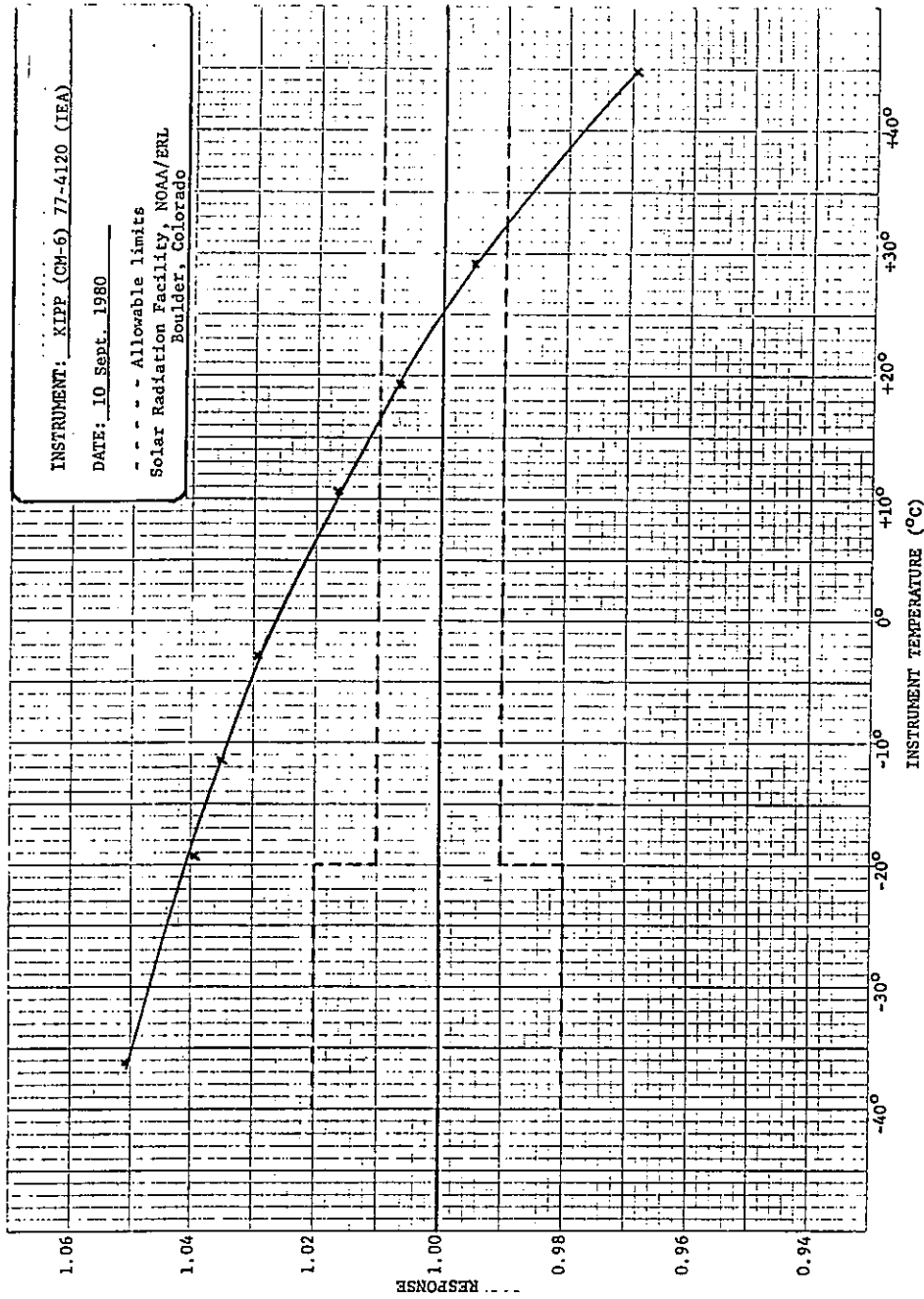

Figure 30: Temperature chamber test data for Kipp & Zonen (CM-6) 77-4120.

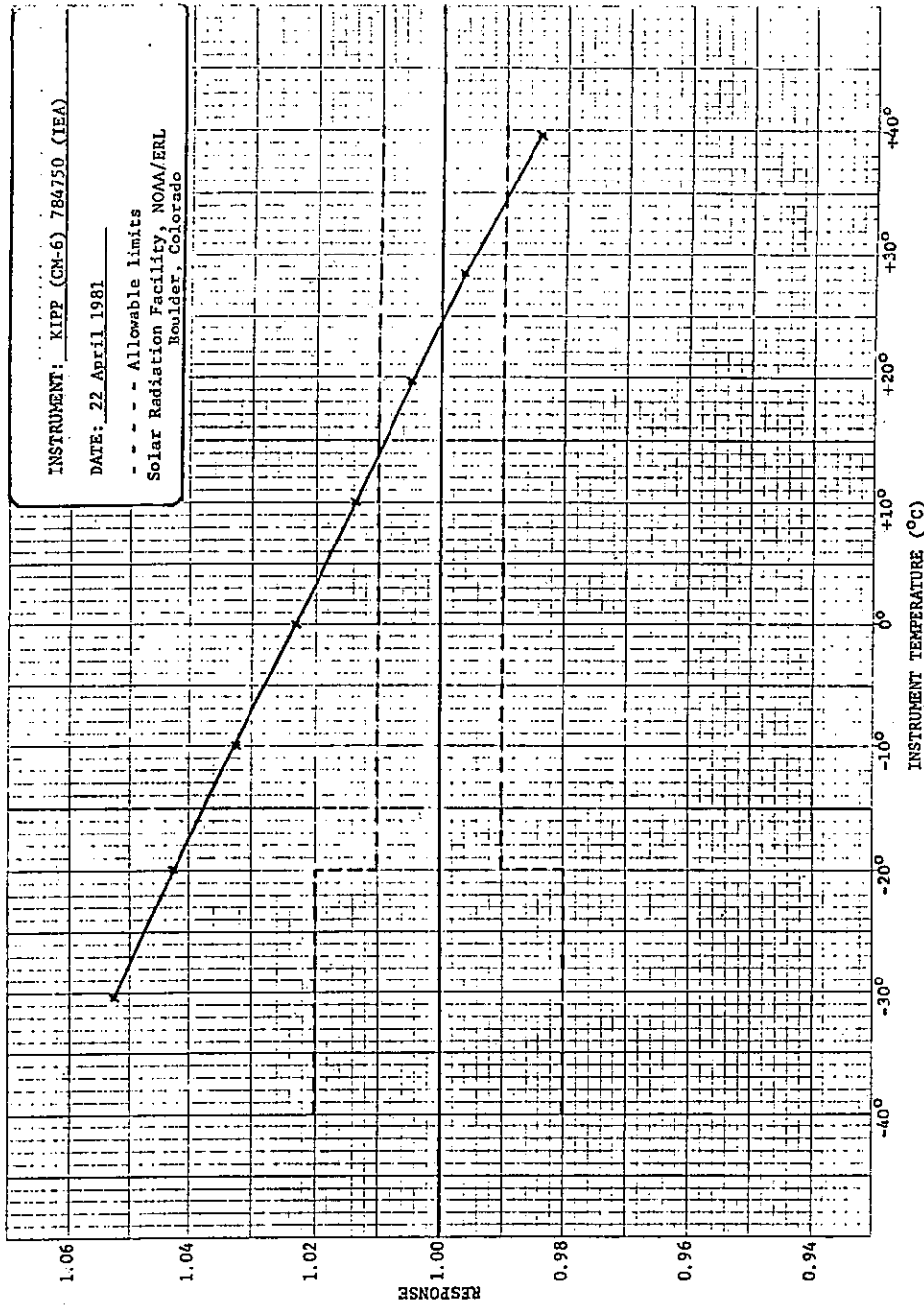

Figure 31: Temperature chamber test data for Kipp & Zonen (CM-6) 78-4750.

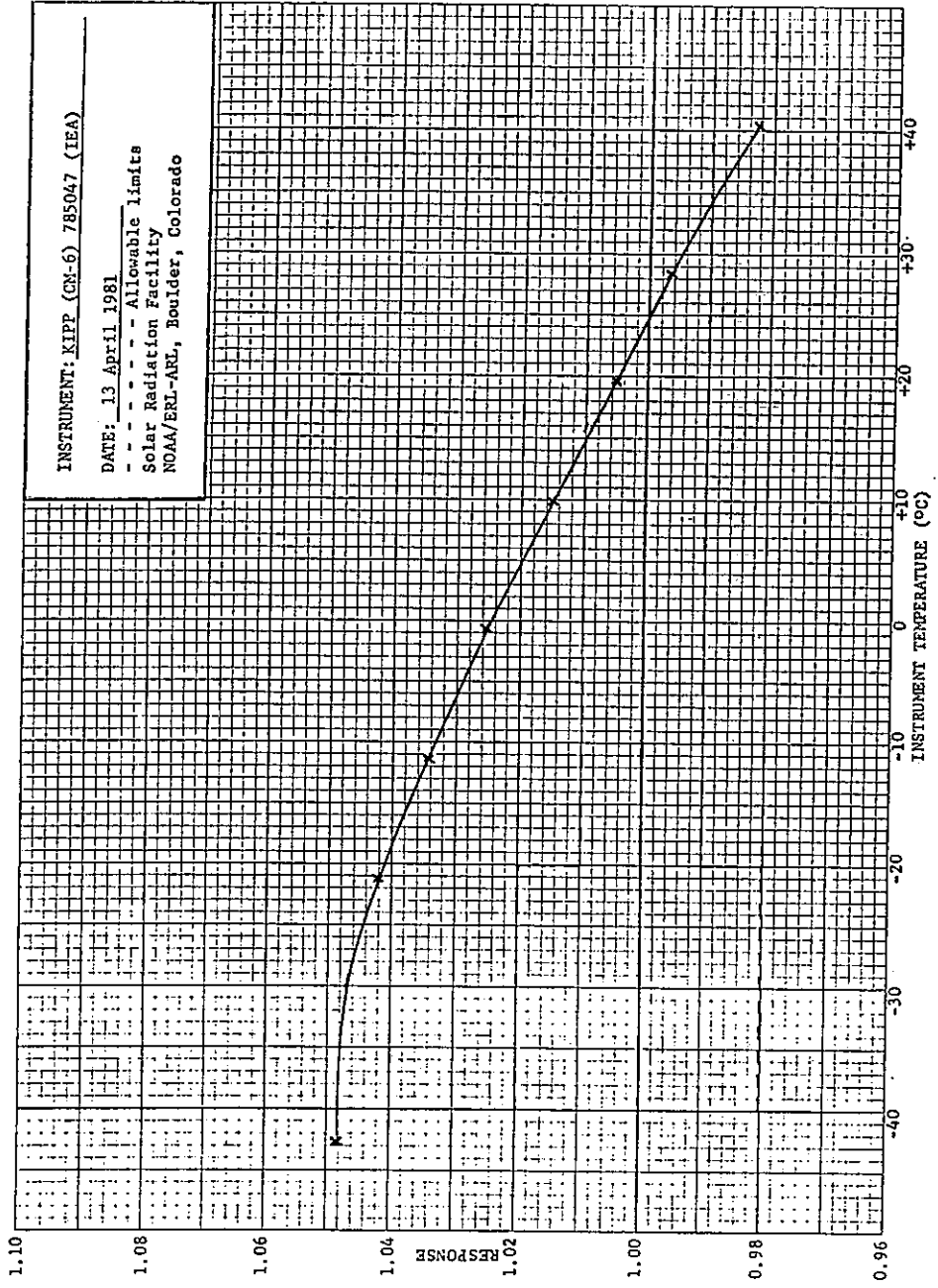

Figure 32: Temperature chamber test data for Kipp & Zonen (CM-6) 78-5047.

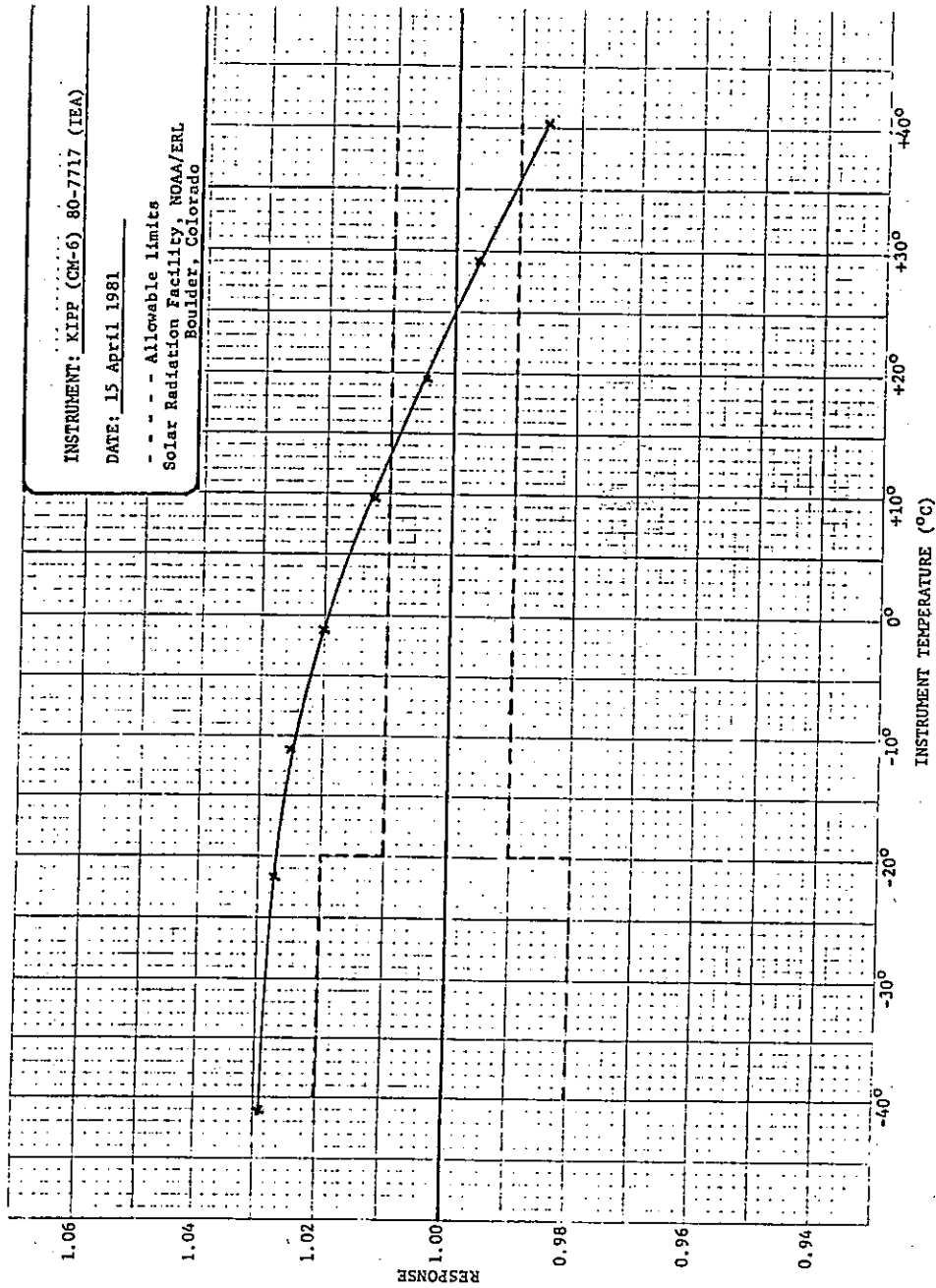

Figure 33: Temperature chamber test data for Kipp & Zonen (CM-6) 80-7717.

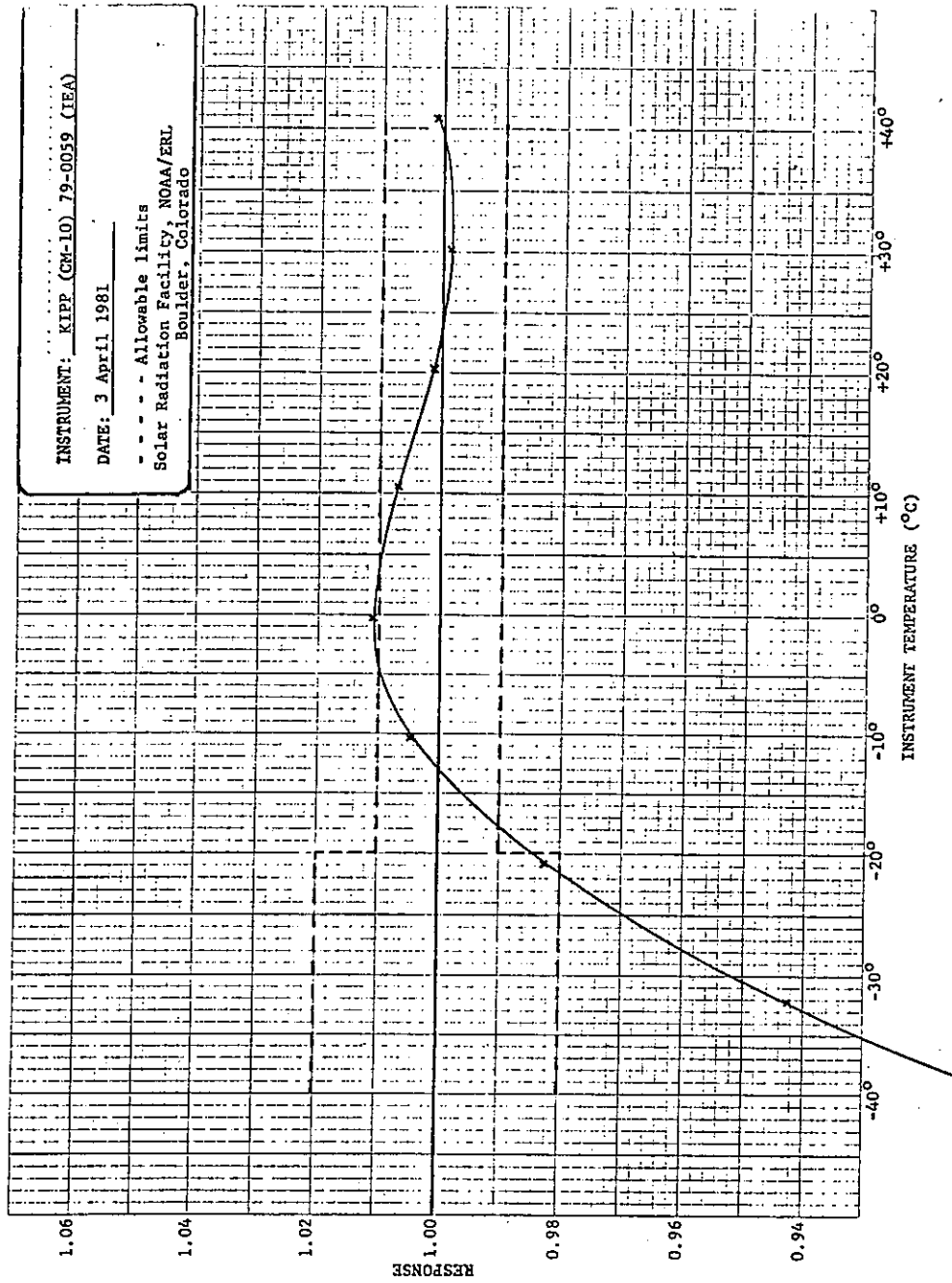

Figure 34: Temperature chamber test data for Kipp & Zonen (GM-10) 79-0059.

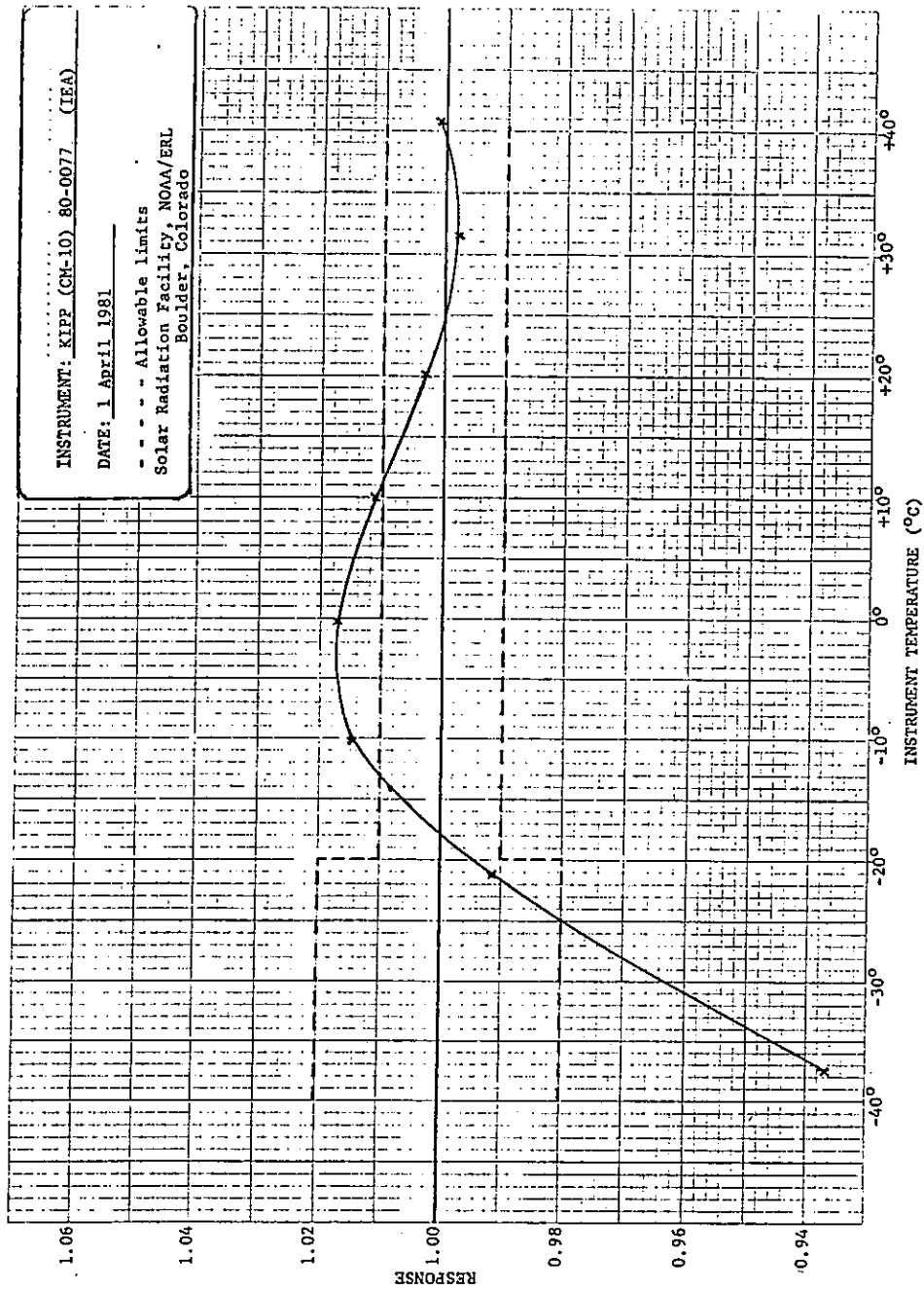

Figure 35: Temperature chamber test data for Kipp & Zonen (CM-10) 80-0077.

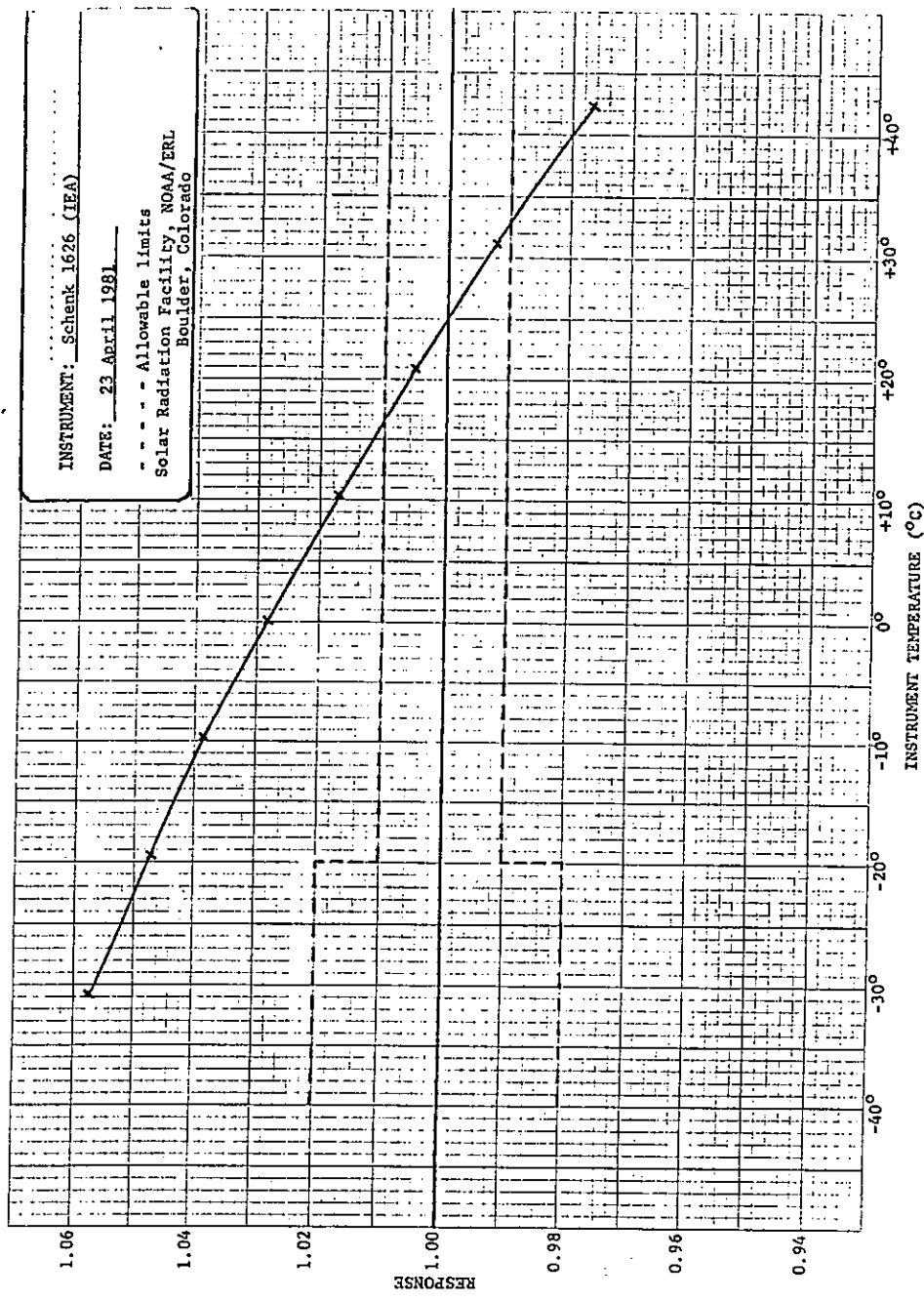

Figure 36: Temperature chamber test data for Schenk 1626.

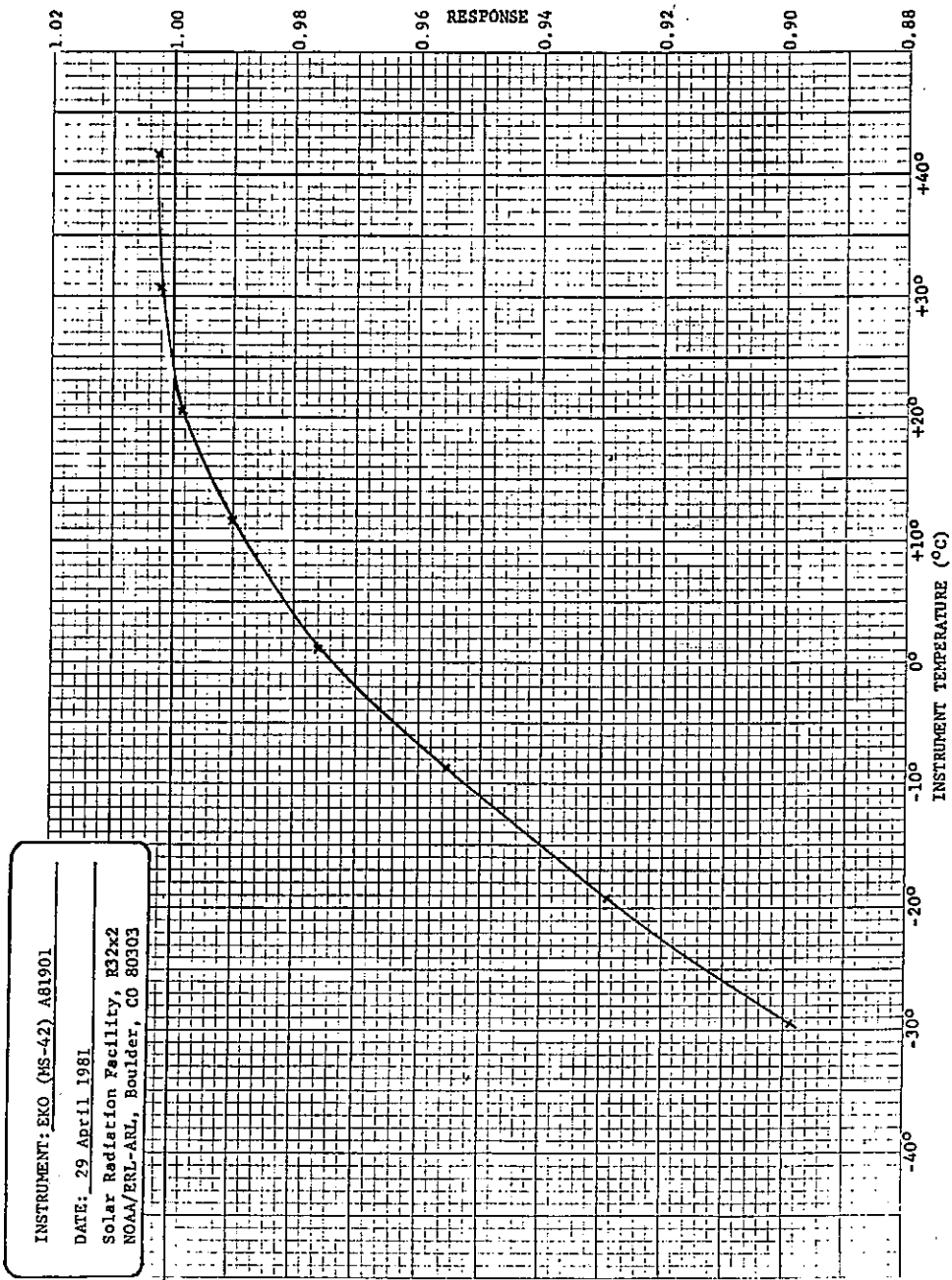

Figure 37: Temperature chamber test data for EKO (MS-42) A81901.

INSTRUMENT: EKO (MS-42) A81902
 DATE: 28 April 1981
 Solar Radiation Facility, R32x2
 NOAA/ERL-ARL, Boulder, CO 80303

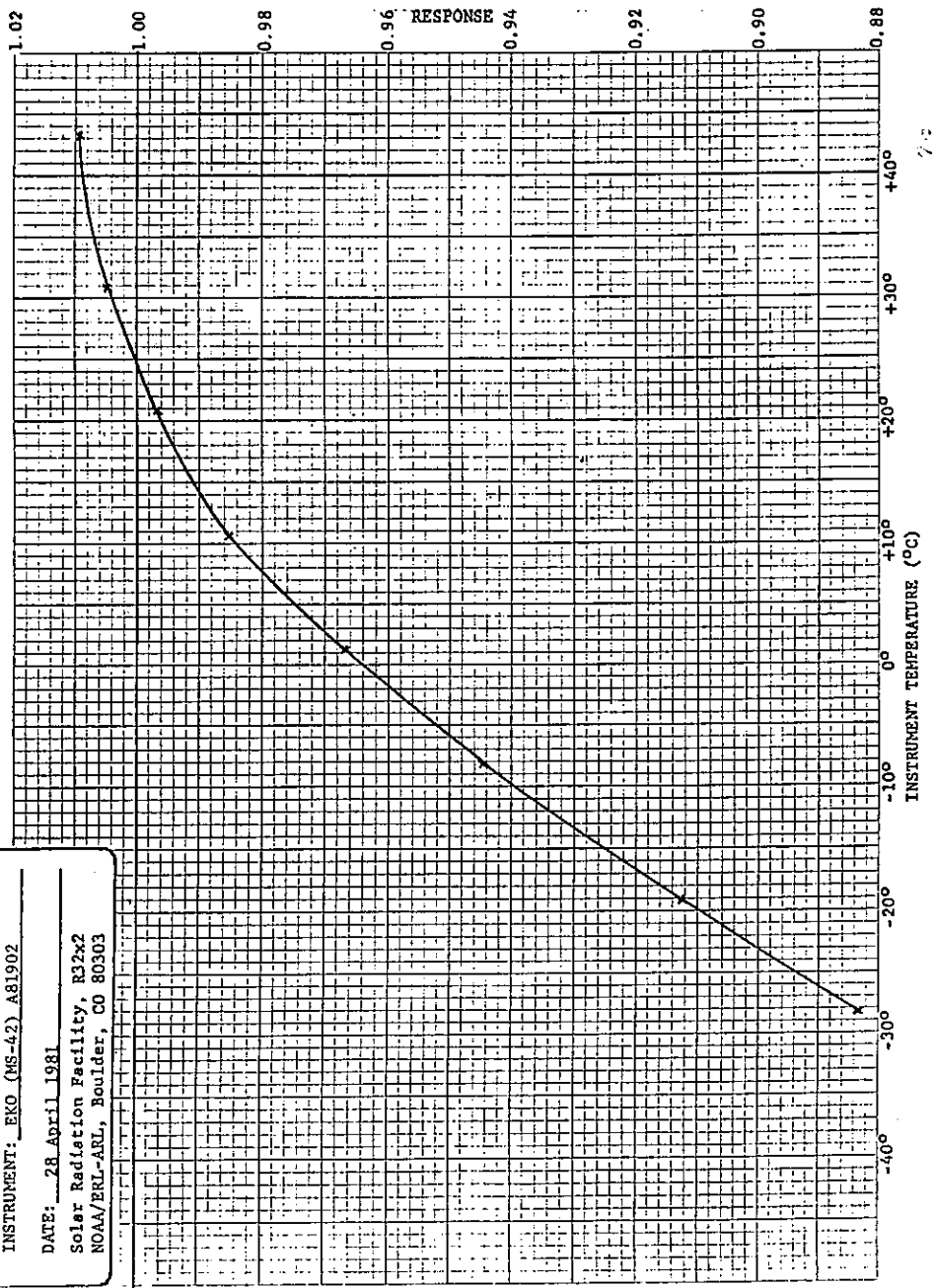

Figure 38: Temperature chamber test data for EKO (MS-42) A81902.

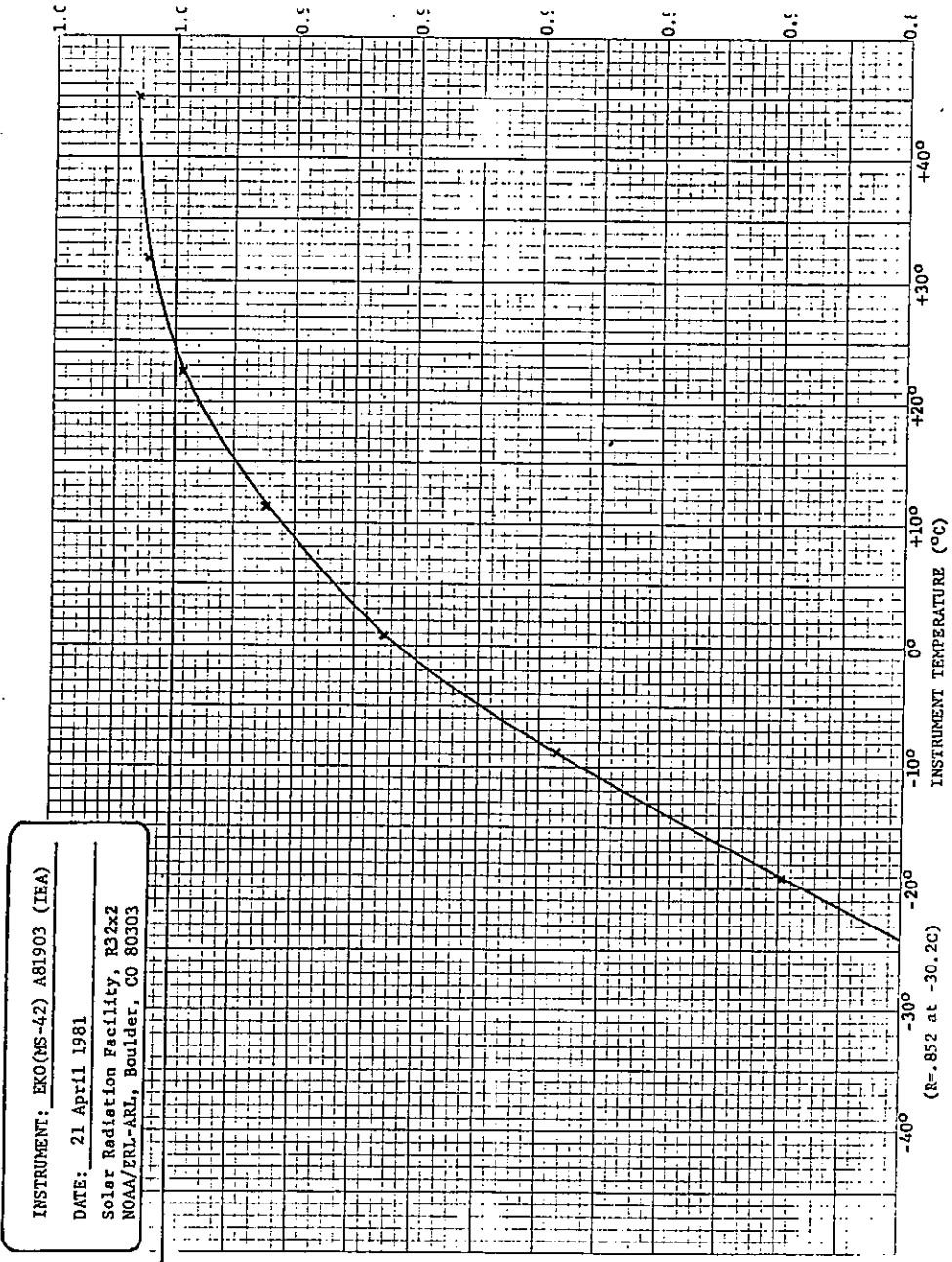

Figure 39: Temperature chamber test data for EKO (MS-42) A81903.

APPENDIX H

NOAA Solar Radiation Standards

by

Edwin Flowers
National Oceanic and Atmospheric Administration
Solar Radiation Facility R32x2
325 Broadway
Boulder, Colorado 80302
U.S.A.

NOAA SOLAR RADIATION STANDARDS

Edwin Flowers
NOAA/ERL-ARL, R32x2
Solar Radiation Facility
Boulder, CO. 80303

LIST OF FIGURES

1. NOAA calibration chain for pyrhemometers, 1970-1980
2. Time plot of response of control pyrhemometers to the primary reference instrument TMI 67502
3. NOAA calibration chain for pyranometers, 1970-1980
4. Time plot of response of reference pyranometers to reference Eppley 14886
5. Time plot of response of control pyranometers to reference Eppley 14886
6. Temperature response curves for control pyrhemometer 14857 and 3 reference pyranometers, Spectrolab 73-1, Eppley PSP 9012, 14860 and 14886.
7. Shade calibrations of Eppley PSP 14860 for 1978
8. Shade calibrations of Eppley PSP 14860 for 1979
9. Shade calibrations of Eppley PSP 14860 for 1980
10. Shade calibrations of Eppley PSP 14886 for 1980
11. List of reference and control pyranometers and pyrhemometers, their period of use, and nominal calibration values.

NOAA CALIBRATION CHAIN
PYRHELIOMETERS

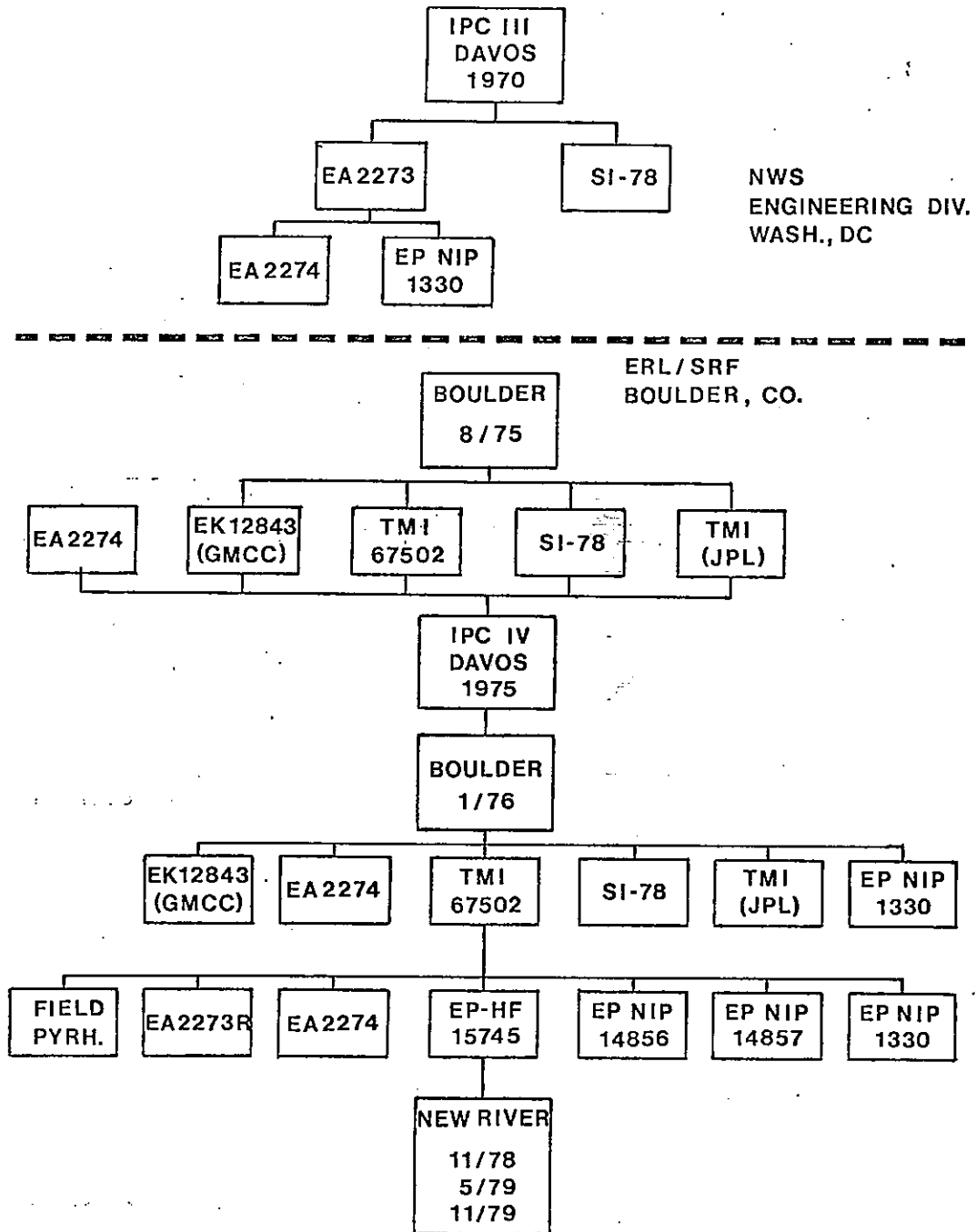

FIGURE 1.

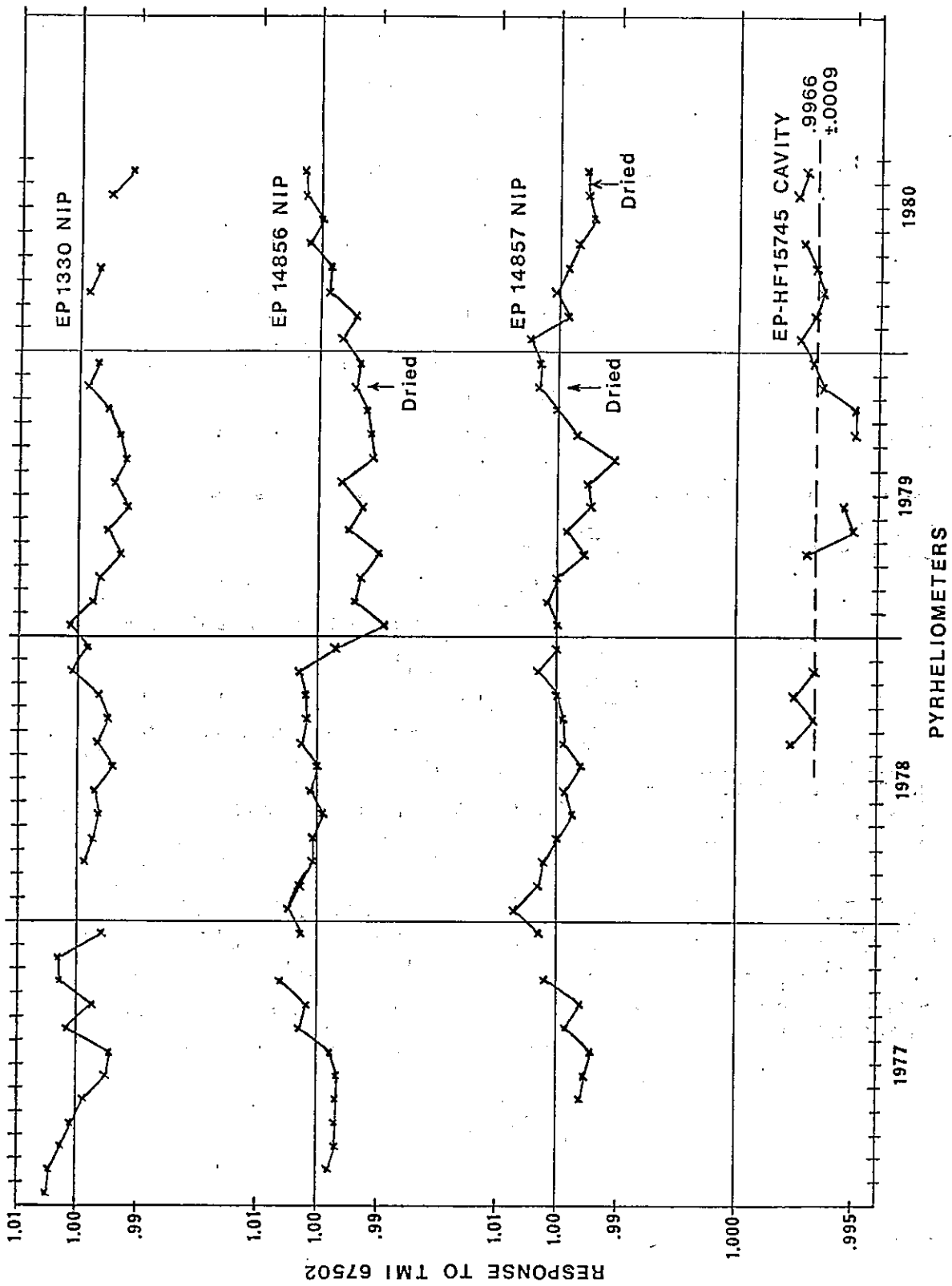

FIGURE 2.

NOAA CALIBRATION CHAIN
PYRANOMETERS

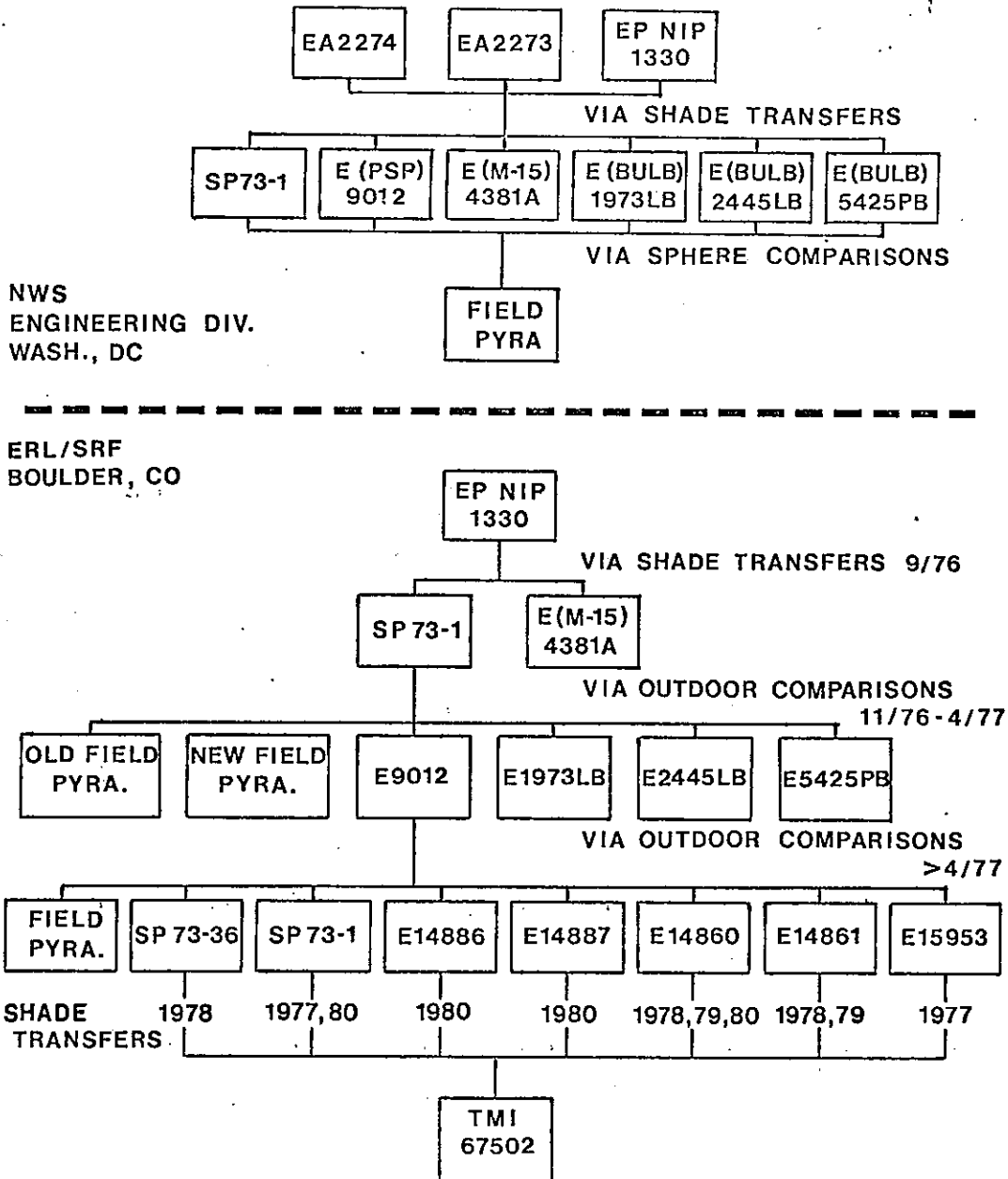

FIGURE 3.

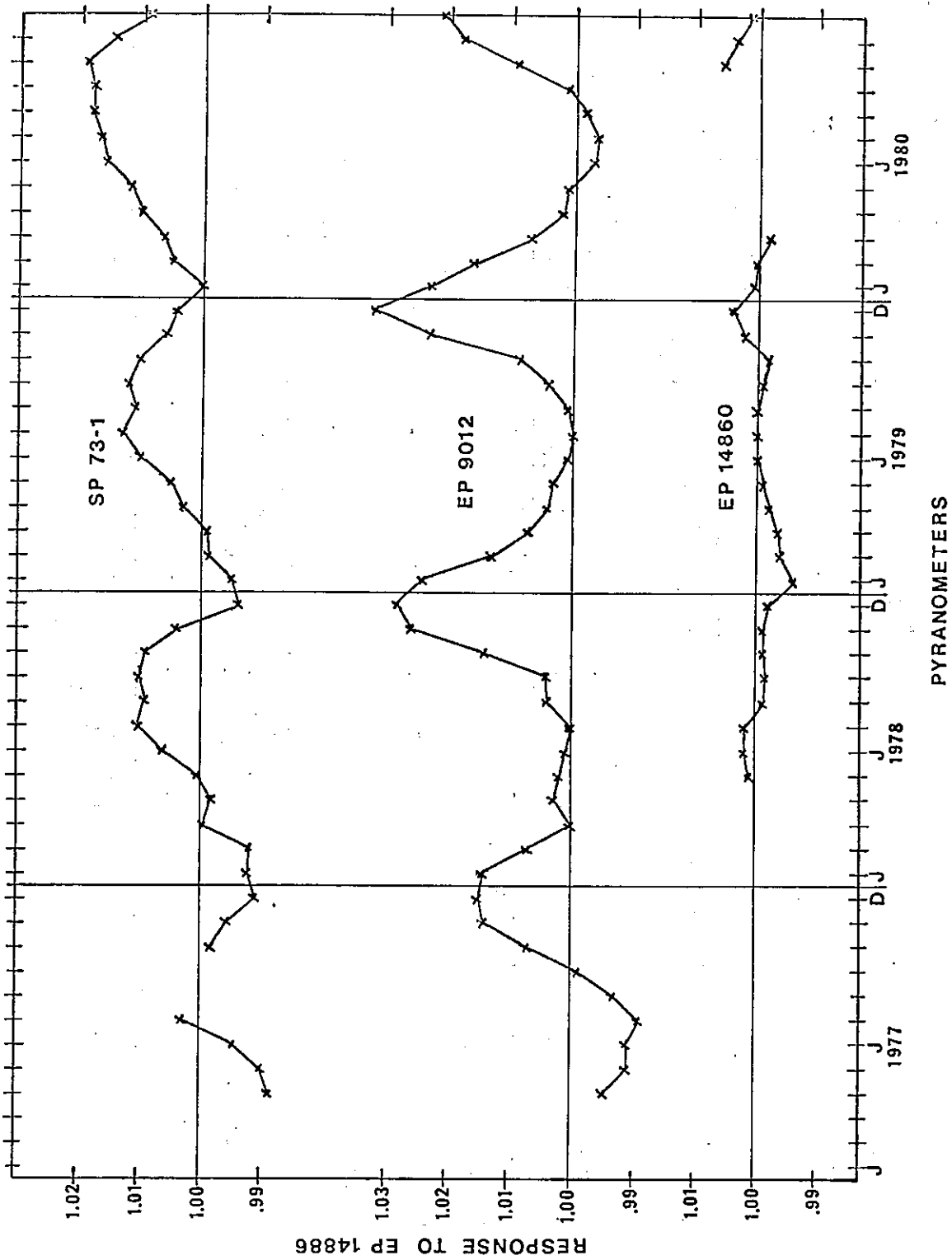

FIGURE 4.

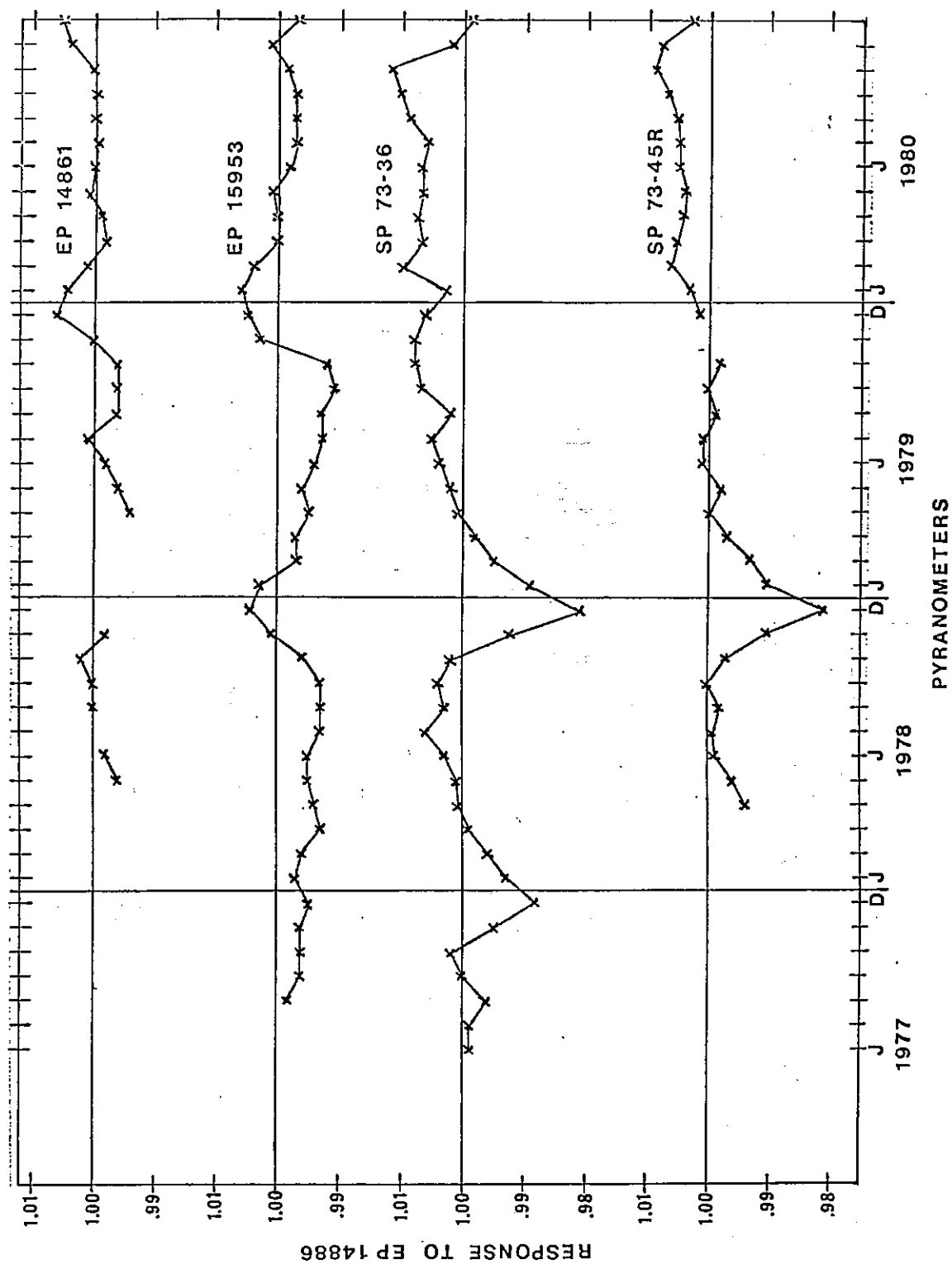

FIGURE 5.

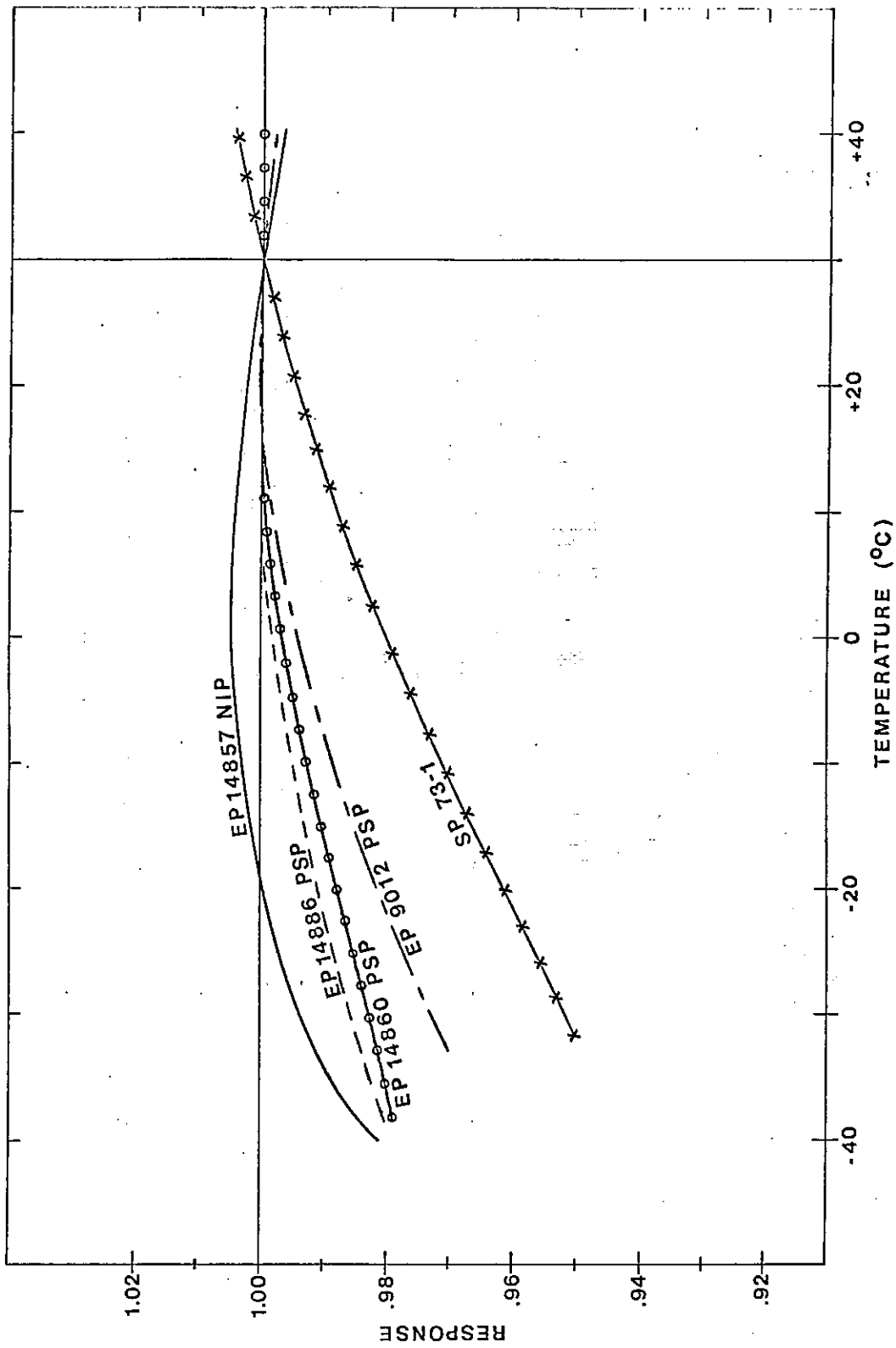

FIGURE 6.

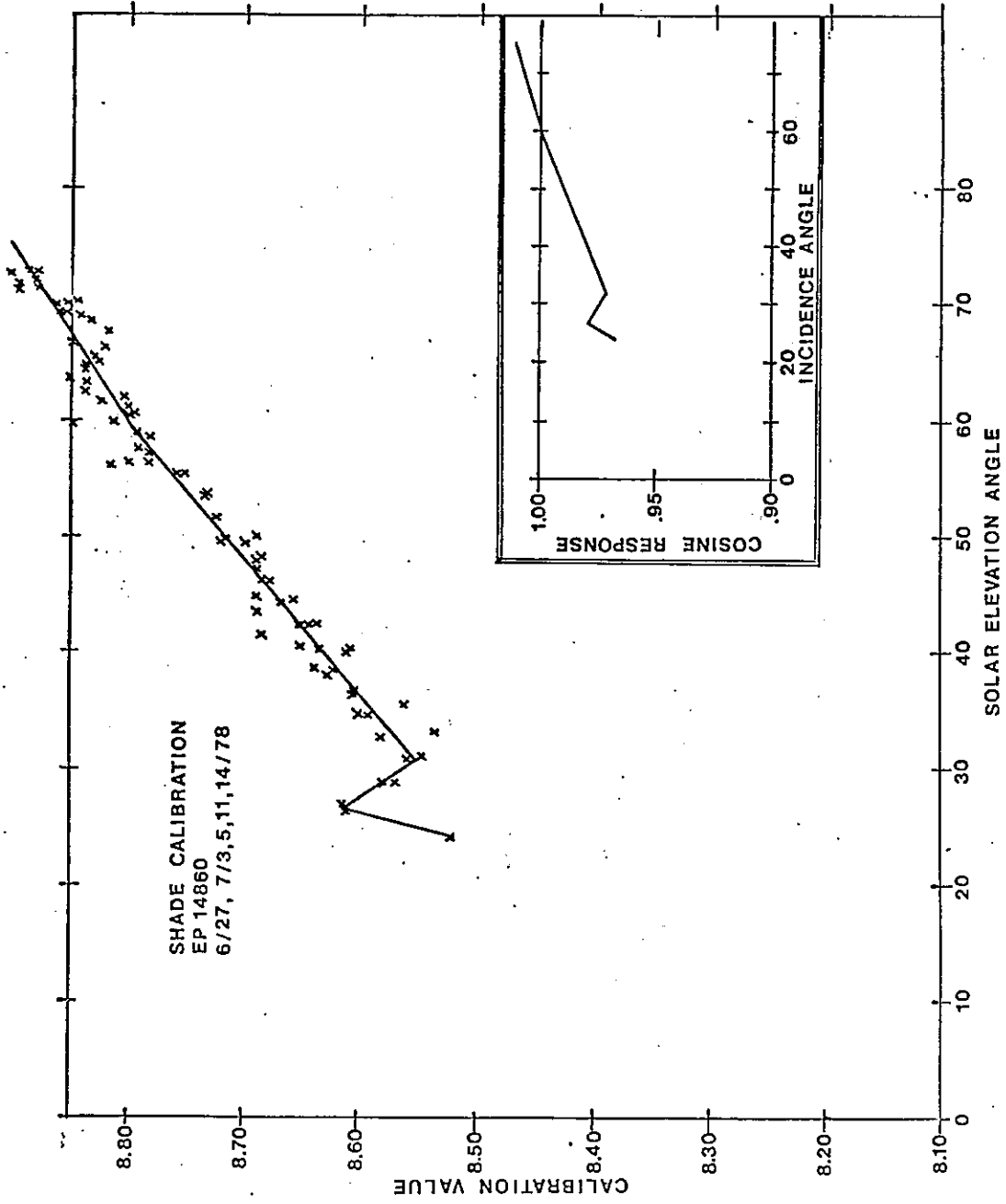

FIGURE 7:

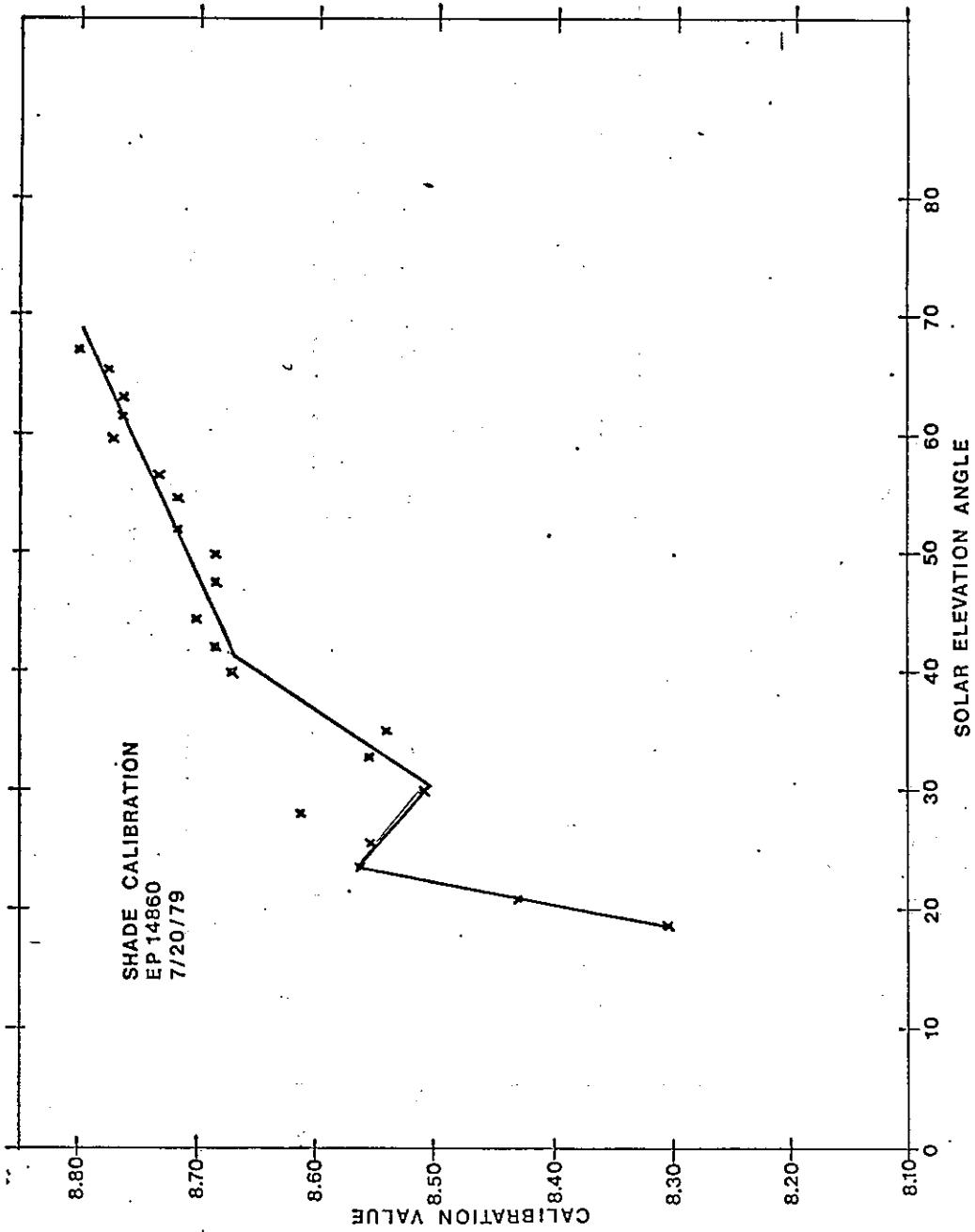

FIGURE 8.

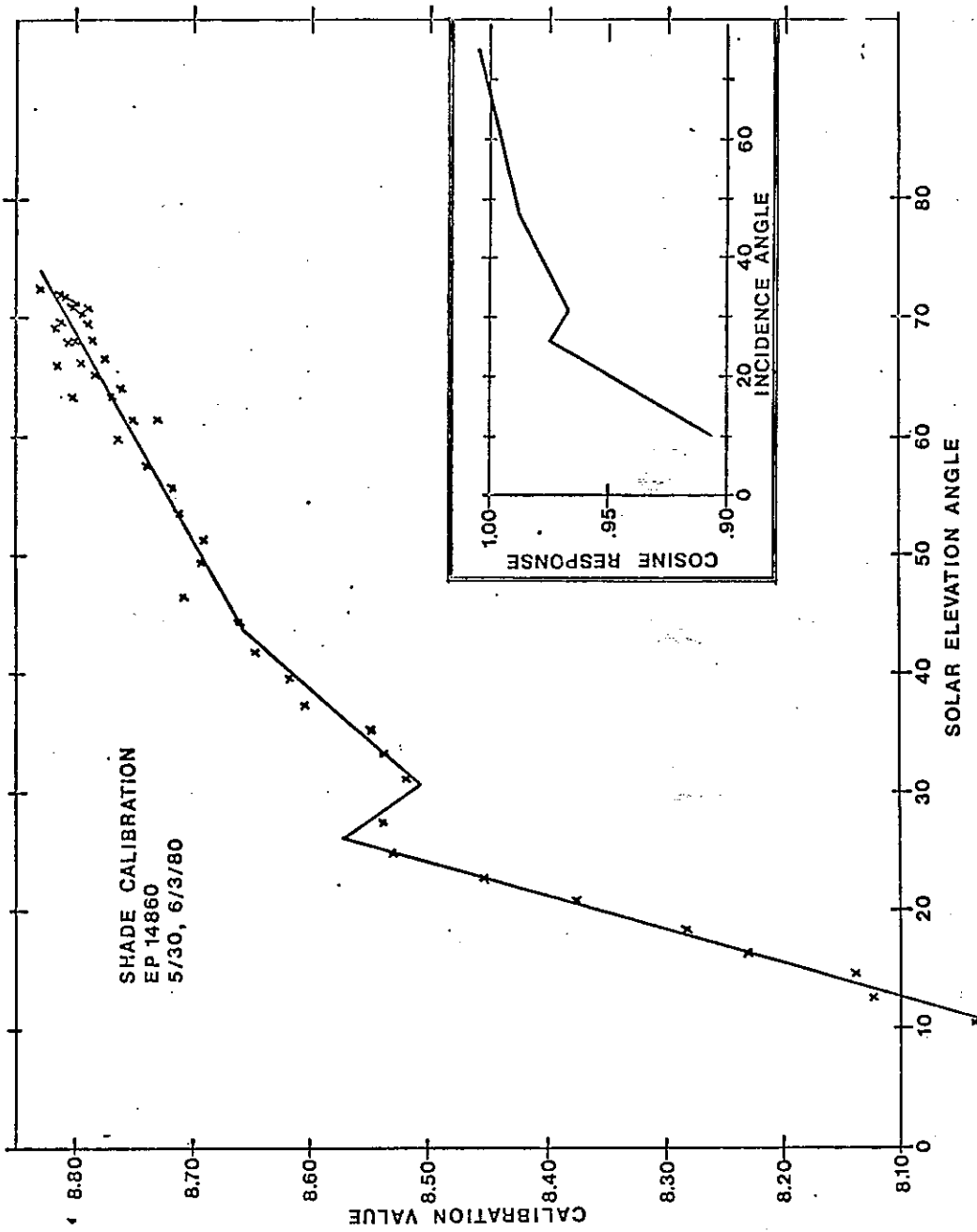

FIGURE 9.

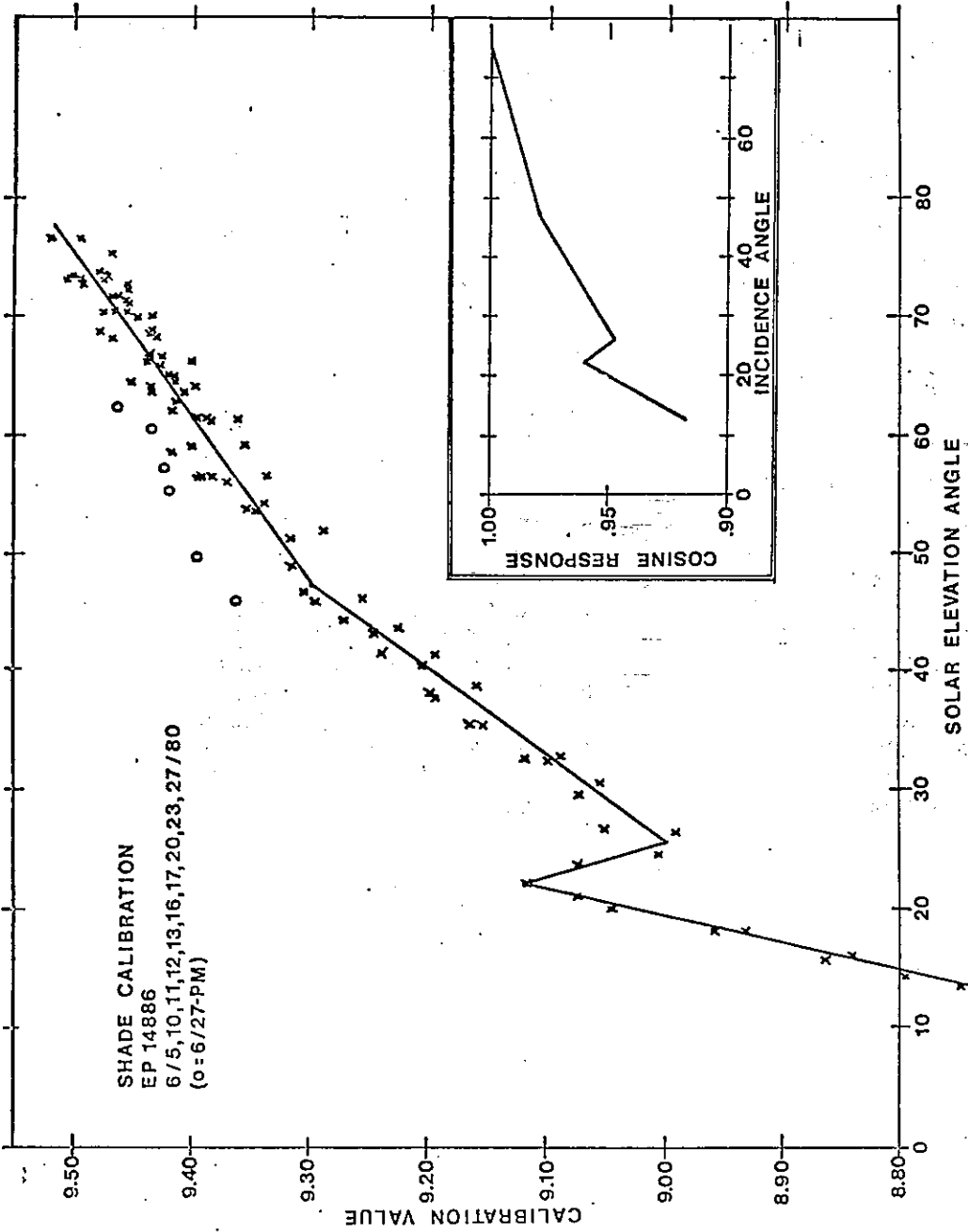

FIGURE 10.

	PERIOD	CALIBRATION (MV/10 ³ W-M ⁻²)
REFERENCE PYRHELIOMETER:		
TMI 67502	> 8/75	(SELF)
CONTROL PYRHELIOMETERS:		
E HF15745	> 8/78	(SELF)
E 1330	> 1/77	2.672
E 14856	> 2/77	8.067
E 14857	> 5/77	8.329

REFERENCE PYRANOMETERS:		
SP 73-1	11/76-6/15/77	7.995
E 9012	6/16/76-3/25/78	5.115
E 14886	3/26/78-6/4/80	9.496
E 14860	6/5/80-	8.798
CONTROL PYRANOMETERS:		
SP 73-1	> 6/15/77	7.995
SP 73-36	> 6/8/77	8.052
SP 73-45R	> 3/29/78	9.559
E 9012	> 3/26/78	5.115
E 10154 (GMCC)	2/19/78-11/16/79; > 6/80	5.740
E 12687-Q	4/22/77-2/27/78; > 1/1/80	9.010
E 14860	5/1/78-6/4/80	8.798
E 14861	> 5/1/78	9.079
E 14886	4/3/77-3/25/78; > 6/5/80	9.496
E 14887	> 12/76	9.881
E 15953	> 8/3/77	10.280

FIGURE 11.

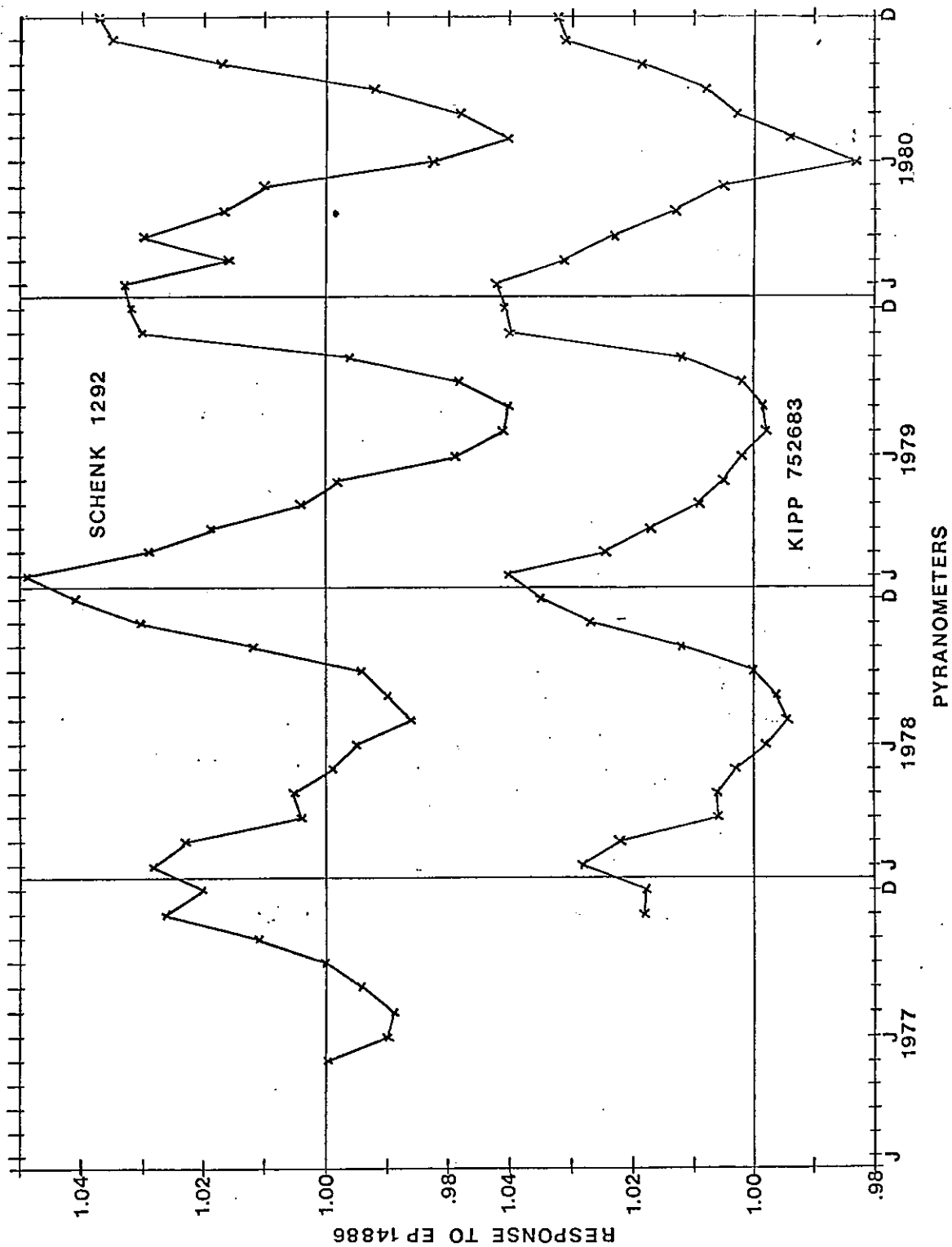

FIGURE 12.

APPENDIX I

**Report of Tests of Three Pyranometers which were
Included in the March 1980 IEA Intercomparisons
at Davos, Switzerland**

by

John Hickey
The Eppley Laboratory, Inc.
12 Sheffield Avenue
Newport, Rhode Island 02840
U.S.A.

THE EPPLEY LABORATORY, INC.

12 Sheffield Ave., Newport, R. I. 02840, U.S.A. Telephone 401 847-1020



Scientific Instruments
for Precision Measurements
Since 1917

January 20, 1981

Report of tests of three pyranometers which were included
in the March 1980 IEA intercomparisons at Davos, Switzerland

1. Introduction:

This report includes a description of the testing and the results of calibrations performed on three pyranometers which were sent to Eppley Laboratory as part of a "round-robin". Two of the instruments were Eppley model PSP and one was a Kipp. All three of the instruments had previously been tested at NOAA/SRF (Ed Flowers) and at the DSET Laboratories (Gene Zerlaut). The instruments arrived at Newport in early October while the Eppley reference H-F pyr heliometer was at IPC V in Davos. Also the instruments were shipped from Newport in early December. There was a very limited range of solar elevation during the period. The major part of the testing was performed between October 10 and November 5, 1980. The testing was scheduled as allowed by the weather, the availability of personnel and equipment and other internal considerations. At the end of the tests the instruments were forwarded; two to the Canadian Atmospheric Environment Service (D. Wardle) and one to DSET. The instruments are identified below.

Type	Serial No.	Owner
Eppley PSP	14806 F3	NBS
Eppley PSP	19129 F3	DSET
Kipp	774120	Kernforschungslage, FRG

The tests and results are described below.

2. Test program:

It was intended to perform three different types of testing in this program.

- (1) Calibrations in the Eppley diffuse hemisphere:
This was to be referenced to the transfer standard normally employed for this purpose.
- (2) Calibrations in direct sunlight by the shading technique:
This testing employs a model H-F cavity pyr heliometer as reference.
- (3) Intercomparison of the instruments for measurement of global radiation over a range of meteorological conditions:
During this testing the three instruments were referenced (ratioed) to a fourth instrument; another PSP.

The restrictions mentioned above curtailed the program to some extent. The major restriction was the reduced range of solar elevations for which shadings and global intercomparisons could be performed. The

maximum solar elevation of 40° was encountered very early in the period before the H-F was returned from IPC V.

3. Calibrations in the Eppley Hemisphere:

The reference instrument for this testing was PSP serial no. 13055F3. It was noted that all the PSP instruments which were included at Davos in March of 1980 were calibrated against this reference. It is noted however that the sensitivity of the reference had been changed twice since its use for the original calibration of instrument 14806. The first change was the initial adjustment from IPS '56 to WRR. The second adjustment was a routine calibration adjustment. This last adjustment was apparently based on recalibrations of specimen pyranometers by Eppley and NOAA/SRF. This identification of adjustments has led us into a more detailed investigation of the reference instruments as well as recalibrations. These latter tests are still in progress mainly because of the limited solar elevation and will be continued through the Summer of 1981. They will not be discussed at length here. One of the most striking realizations is that the "dome standard" instrument (13055) has a long and detailed history of comparisons with instrument 7577D1. This latter instrument is an Eppley model 2 pyranometer which was included in the 1971 NASA comparisons at Goddard Space Flight Center and also at the Pre-GATE comparisons in Miami. Thus it has an intercomparison history with numerous other reference instruments of many other organizations. Basically the IPS was intended reference for these previous intercomparison. The NOAA and Canadian AES instruments together with 7577D1 were supposed to embody a reference scale termed the "North American Mean". This scale was claimed to prove agreement between the participants of ±1%.

Returning to the relationship of the Eppley "dome-standard" to the IEA comparison at Davos we tabulate below the value used for the sensitivity of the reference for each PSP in the IEA list.

Serial no.	sens. of 13055F3	remarks
14806F3 *	9.51 $\mu\text{V}/\text{Wm}^{-2}$	IPS '56 relative to Angstrom 7644
15834F3	9.31	Reflects change to WRR
16692F3	"	
17750F3	"	
17823F3	"	
18376F3	9.44	adjusted sensitivity
18978F3	"	still WRR
19129F3 *	"	
19222F3	"	

* indicates instruments in this test returned to Eppley

The three pyranometers tested gave the values listed below during this testing. The value employed for the reference was $9.44 \mu\text{V}/\text{Wm}^{-2}$.

serial no.	original value	new value	$\Delta\%$
14806F3	10.02	10.07	+0.5
19129E3	10.76	10.64	-1.1
774120 Kipp	13.7 (from IEA list)	13.09	-4.4

The change in the reference sensitivity between the tests of the PSP instruments was:

-0.736% for 14806

no change for 19129

It would appear that the change in 19129 must be in the instrument or the reference or the test conditions. The latter is unlikely to account for a change of -1.1%. If it is assumed that no change in the test conditions or the reference instrument has occurred since the original calibration of 14806 then its original value adjusted to a reference sensitivity of 9.44 would have been 9.95. This would indicate a increase of 1.2%. In order to investigate this matter further the avenue open to us is to recalibrate the "dome standard" directly against the H-F pyrliometer WRR reference by the shading method. This work has begun, but has been limited by weather and other factors. Initial indications are that a sensitivity of about $9.2 \mu\text{V}/\text{Wm}^{-2}$ is pertinent for low solar angles (less than 35° elevation) and very cold temperatures (near 0°C). The hemisphere calibrations are usually at temperatures near 27°C . If this value is found to be relevant for the other test conditions we can expect that all of the values assigned to 13055F3 in the past have been too high. For example the sensitivity value of 9.31 originally assigned to WRR traceable calibrations 1.2% too high. Consequently radiation values measured by these instruments would be 1.2% too low. If we consider the adjusted value of 9.44 we could predict that radiation values measured by instruments calibrated in that group would be 2.5% too low. The final results and conclusions cannot be stated at this time. However, it can be assumed that measurements taken at low solar elevations and on clear cold days would deviate from WRR by amounts close to those stated above based on this argument alone.

We are not cognizant of any information which would allow us to comment on the difference in calibration factors of the Kipp instrument as relates to this type of hemisphere testing.

4. Calibrations by the shading technique:

As stated previously this type of testing was seriously limited because of the time of year and weather factors. However, some testing was accomplished for all three instruments. The least amount of shadings were for the Kipp Instrument. One advantage of these low angle tests was that it allowed us to confirm the cosine response characteristic that was reported by Ed Flowers for other PSP instruments in his earlier presentations. We were able to achieve fairly rapid shading results because we had developed a computer controlled system for this purpose. We feel that the results that we achieve at angles less than 30° solar elevation with the instruments horizontal is far superior to that which we could achieve in the past. In fact, in the past the very low angles were not even attempted. Primary reference calibrations had generally been performed in the Spring and Fall only. The theory here was that the effective solar elevation angle of the hemisphere radiation was at about 45°.

In these tests it was noted that the cosine corrected sensitivity in the angular range 18 to 30° exhibited a peak in the response near 25° with a subsequent drop-off near 30°. Flowers has reported a similar characteristic. It is noted that this characteristic was identified for the Kipp instrument as well as for the PSP's. The signature appears to be slightly different for different instruments indicating it is a function of the construction as well as the design. Instrument 19129F3 was also calibrated by the shading technique on a tilt. It should be obvious that a tilt of about 60° was necessary to achieve normal incidence conditions. The sensitivity derived in this testing is very close (about 1%) to that achieved at the 25° peak in the horizontal tests. The table below shows the pertinent results:

Instrument	original value	shading value	tilt value
14806F3	10.02 $\mu\text{V}/\text{Wm}^{-2}$	9.29 at 24.1° 9.16 at 30°	not available
19129F3	10.76	10.29 at 24-25° 10.05 at 30°	10.34 at 90° 10.31 at 80° 10.25 at 55°
774120 Kipp	13.7 (IEA list)	12.3 to 12.4 22 to 25° 12.15 at 30°	not available

Investigation of the effects noted above is continuing for PSP type instruments. These results will be reported later.

The table below contains a comparison of the hemisphere and shading calibrations.

instrument	original	Sensitivity $\mu\text{V}/\text{Wm}^{-2}$		
		hemisphere*	25° shading	normal/tilt
14806F3	10.02	10.07	9.29	N/A
19129F3	10.76	10.64	10.29	10.34
774120 Kipp	13.7	13.09	12.35	N/A

* hemisphere calibration using 9.44 for instrument 13055F3

This abbreviated table shows that all of the sensitivities derived during these tests are below the reported original values for all instruments and conditions except the hemisphere calibration of 14806F3 which should not have agreed because of the scale change. The ratios of the hemisphere to 25° shading results show that the hemisphere values are always higher:

Instrument	hemisphere/ 25° shading
14806F3	1.084
19129F3	1.034 (1.029 for normal/tilt)
774120	1.060

Instrument 19129F3 appears to have the most repeatable values with a spread of only 3.4%. The other PSP (14806F3) has the worst spread at 8.4% while the Kipp instrument is in between with a 6% spread. As stated previously these agreements would be better if the lower true sensitivity of the dome standard is lowered to 9.2 from 9.44. Such an adjustment would bring 19129F3 into the 1% agreement range.

5. Simultaneous exposure results:

Prior to the time that the reference pyrhelimeter was returned from IPC V the three specimen instruments were exposed in the horizontal configuration for a number of days. The fourth (reference) instrument included in this exposure test was another PSP serial number 18135F3. This instrument is employed at Eppley as a transfer instrument for various outdoor calibrations and is probably the best characterized instrument available here for these purposes. It is the instrument on which the continuing tests are performed as mentioned above. Like The other instruments 18135F3 has the characteristic response curve in the 20 to 30° solar elevation range. Thus the exposure ratios of the other instruments to it contain the information of the deviation of the effect among the specimens. These comparisons were handled by a computer data system with no human intervention. A few general comments can be made about the results of these tests. First, there appears to be an azimuthal dependence of the relative cosine response functions. instrument 14806F3 produced lower ratios in the morning than for the same sun angles in the afternoon. Instrument 19129F3

shows the opposite effect being lower in the afternoon. The three PSP's generally agreed with each other through the middle of the day to better than $\pm 1\%$. The Kipp instrument generally reads higher in radiation showing a decline in its ratio to the reference over the course of the day. It must be remembered that even the mid-day solar elevation is not large and that the range of solar elevations is in the angular range for which the cosine response anomaly has been identified. Therefore it will take further investigation to rectify all of these results. The results of the simultaneous exposures in the absolute sense are dependent on the value of the sensitivity entered into the computer program. Since most of these tests were performed prior to the other calibrations mentioned above another analysis will be required to rectify the ratios to a uniform reference.

6. Summary;

These intercomparisons have directed our attention to a number of pertinent areas of investigation. We find that the cosine anomaly identified by Flowers exists to some extent in all of the instruments involved in this round robin. We have raised some questions as to traceability of the Eppley hemisphere calibration to the WRR. We find a high consistency in the measured irradiance by similar instruments if the ratio alone is considered. We find evidence of small azimuthal response deviations. Recalibrations of instruments appear to be within the limits expected at the $\pm 1\%$ to $\pm 1.5\%$ level when consistent standards and references are employed.

Probably the most important finding of this set of tests is the difference between dome calibrations and the low angle shadings. Even here the recalibration of the PSP 19129F3 shows a reasonable agreement. It is suspected that some minor change has occurred to instrument 14806F3. In the table below we compare our results with those of DSET and NOAA/SRF from this round robin. We try here to compare the most similar situations and conditions.

instrument	Eppley value	DSET value	NOAA value
14806F3	9.29 (25°)	9.73 (horiz)	9.26 (20°)
19129F3	10.29 (25°)	10.43 (horiz)	10.41 (20°)
19129F3	10.34 (norm/tilt)	10.41 (norm)	10.51 (40°tilt)
774120	12.35 (25°)	12.16 (horiz)	12.96 (20°)

Low solar angles and low temperatures were not experienced during the DSET testing to the best of our knowledge. Again instrument 19129F3 exhibits the best agreement among results from the different facilities. The total range of all values tabulated for it in this table is about 2.2%.

We intend to devote more effort to the definition of the angular response problem in order to improve instrument performance.

APPENDIX J

**Eppley Laboratory: Abbreviated Description
of Pyranometer Calibration Techniques**

by

John Hickey
The Eppley Laboratory, Inc.
12 Sheffield Avenue
Newport, Rhode Island 02840
U.S.A.

**Eppley Laboratory: Abbreviated Description of Pyranometer
Calibration Techniques**

by John Hickey, The Eppley Laboratory, Inc., Newport, RI 02840 USA

Routine calibrations of pyranometers at the Eppley Laboratory are performed in the diffuse hemisphere* by exposing the instrument under test as well as a reference pyranometer of the same type simultaneously. The reference pyranometer is periodically calibrated in direct sunlight by the shading technique against a self-calibrating cavity pyrliometer of the H-F type which is directly traceable to the World Radiation Reference scale (WRR). The sensitivity value employed in the hemisphere is that derived from a 45° solar zenith angle. All model PSP instruments are temperature compensated and tested in a temperature chamber. The instruments are irradiated by a tungsten filament spotlight while the temperature is varied from -20°C to +40°C.

For the IEA comparison instruments, cosine, azimuth, and tilt angle tests will be performed by the shading method against a self-calibrating pyrliometer traceable to WRR. The pyranometer under test is mounted to a variable elevation device which is itself mounted to a rotating table. Exposures over the available range of solar zenith angles are obtained for horizontal mounting and various tilt angles.

*Reference - Hill, A. N., J. R. Latimer, A. J. Drummond, and H. W. Greer, 1966: "Standardized Procedures in the North American Continent for the Calibration of Solar Radiation Pyranometers", Solar Energy 10, No. 4, pp. 1-11.

APPENDIX K

**The Background to NARC Calibration Methods:
Explanation of Figures from Presentation at
Boulder IEA Meeting, 17 March 1981**

by

David Wardle
National Atmospheric Radiation Centre
Atmospheric Environment Service
4905 Dufferin Street
Downsville, Ontario M3H 5T4
Canada

The Background to NARC Calibration Methods

Explanation of Figures from Presentation at Boulder IEA Meeting 17 March 1981

by David Wardle

Figure 1

Summary and comparison of manufacturers' calibration factors with those determined by NARC early in 1981 and with those inferred from the comparison exercise at PMOD during March 1980.

Figure 2

Record of the movements of pyranometers to NARC and on to ERL. This is included to show the incredible delays involved in mailing instruments as opposed to sending them via air line companies.

Figure 3

The NARC specification of pyranometer sensitivity has been developed primarily for the Canadian radiation network, which covers a very wide range of latitudes. The NARC specification is based on measurements at Mt. Kobau during July on clear days, and this diagram shows the range of solar positions then. Also shown are the solar positions at hourly intervals at Resolute in summer (RS) and at Toronto in summer and winter (TS&TW). The solar positions at Davos on the day of the comparison (Julian day 66) are indicated as DP.

Figure 4

Mt. Kobau calibration of Schenk #525. Note that the morning values are as much as 3% less than the afternoon ones. Later laboratory measurements identified this being caused by a 1.5° tilt of the sensor with respect to the instrument body.

Figure 5

Mt. Kobau calibration of Kipp #75-2950. Each point represents a 30 minute integration on any of seven days. Note the total spread of about 2-1/2%.

Figures 6 and 7

Mt. Kobau calibrations of Eppley #11667 by reference to the Abbot pyranometer and by occultation.

Figures 8, 9 and 10

Laboratory measurements of the departure from the ideal response as a function of incidence angle. Note that the 1978 and 1975 groups are essentially similar while the earlier group is much worse. By interchanging the dome

assemblies on early and later instruments one can show that the difference is due entirely to the seated height of the dome.

Figure 11

Laboratory measurements of angular response of 30 Eppley PSP and model 2 pyranometers.

I.E.A. TASK III-V PYRANOMETER ROUND ROBIN TESTS -- TORONTO 5/3/81

SERIAL NO	OWNER	MANUFAC TURER'S K	#####		MANU.K	MANU.K	NARC K
			#NARC#	-----	-----	-----	
			# K	#	NARC K	PMOD K	PMOD K
#####							
14806	NBS	USA	10.32	# 9.66#	1.037	1.066	1.028
15834		SWEDEN	8.99	# 8.74#	1.029	1.065	1.035
16692		DENMARK	9.88	# 9.55#	1.035	1.070	1.034
17750	NRC	CANADA	9.26	# 9.24#	1.002	1.021	1.019
17823	JULICH	F.R.G.	8.97	# 8.67#	1.035	1.060	1.024
18978	DFVLR	F.R.G.	11.30	#10.61#	1.065	1.088	1.022
19129	DSET	USA	10.76	#10.32#	1.043	1.056	1.012
MEANS OF EPPLEY'S					1.035	1.061	1.024
S.D.					.019	.020	.008
75-2438	STUTTART	F.R.G.	11.3	#10.45#	1.081	1.082	1.001
76-3000		SWITZERLAND	11.9	#11.34#	1.049	1.068	1.018
77-3656	MET. OFFICE	U.K.	12.2	#11.48#	1.063	1.064	1.001
77-3992	DFVLR	F.R.G.	12.9	#11.97#	1.078	1.068	0.991
77-4120	JULICH	F.R.G.	13.7	#12.56#	1.091	1.092	1.001
78-4750		BELGIUM	11.7	#10.81#	1.082	1.109	1.025
78-5047		SWITZERLAND	12.5	#11.68#	1.070	1.087	1.016
80-7177	CARDIFF	U.K.	(I)	#10.13#	-	-	-
MEANS OF CM-6'S					1.073	1.081	1.008
S.D.					0.014	0.016	0.012
(II)							
CM10 790059	HAMBURG	F.R.G	5.8	# 5.65#	1.027	1.045	1.018(N)
CM10 800077		NETHERLANDS	5.99*	# 5.83#	1.027	-	- (N)
STAR 1626	VIENNA	AUSTRIA	14.32	#14.51#	0.987	1.016	1.029(N)

OVERALL MEAN							1.017
S.D.							0.013

- (I) Manufacturer's K = 10.9 (17/3/81)
- (II) IPS : Dehne (IPS) = 5.85
- * WRR
- (N) Not tested against acceptable standard

Figure K-1 Summary and comparison of manufacturer's calibration factors with those determined by NARC early in 1981 and with those inferred from the comparison exercise at PMOD during March 1980.

IEA INTERCOMPARISON - RECORD OF PYRANOMETER MOVEMENTS

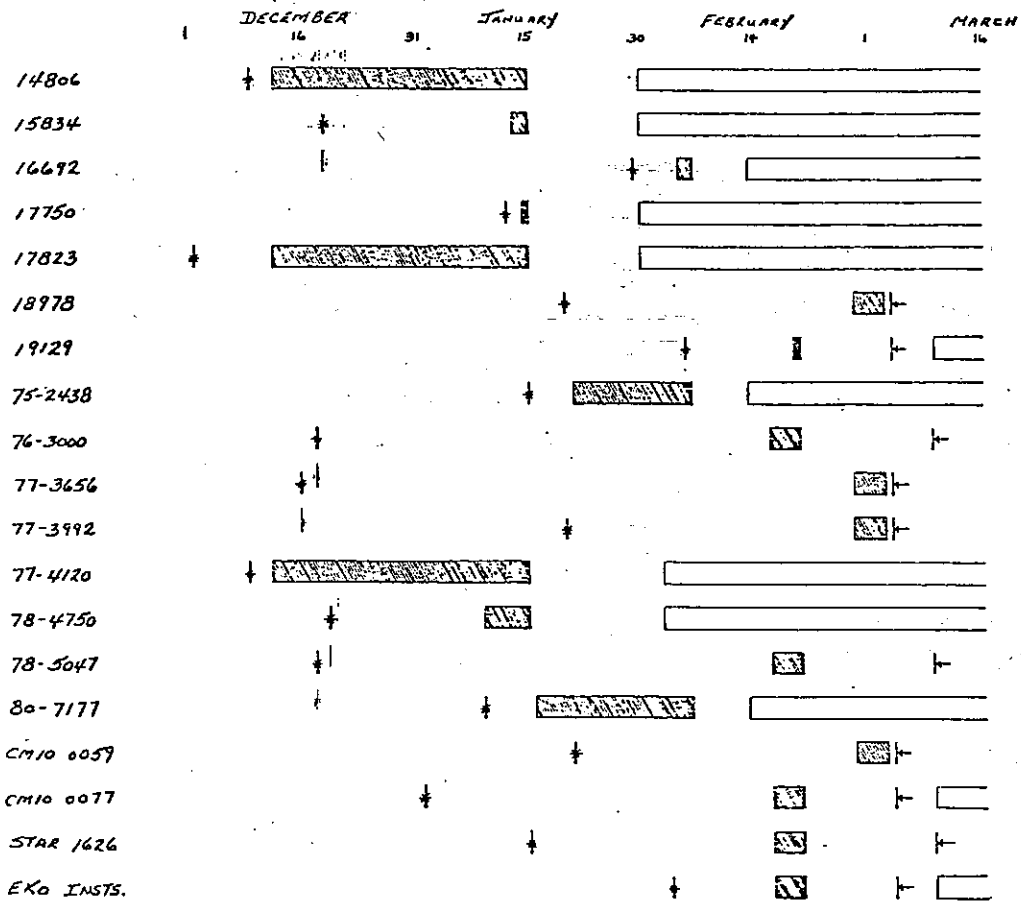

LEGEND: * INST SHIPPED BY OWNER
 [Hatched Box] INST AT NARC
 [White Box] INST AT NOAA/ERL

Figure K-2 Record of the movements of pyranometers to NARC and on to NOAA/SRF. This is included to show the incredible delays involved in mailing instruments as opposed to sending them via Air Line companies.

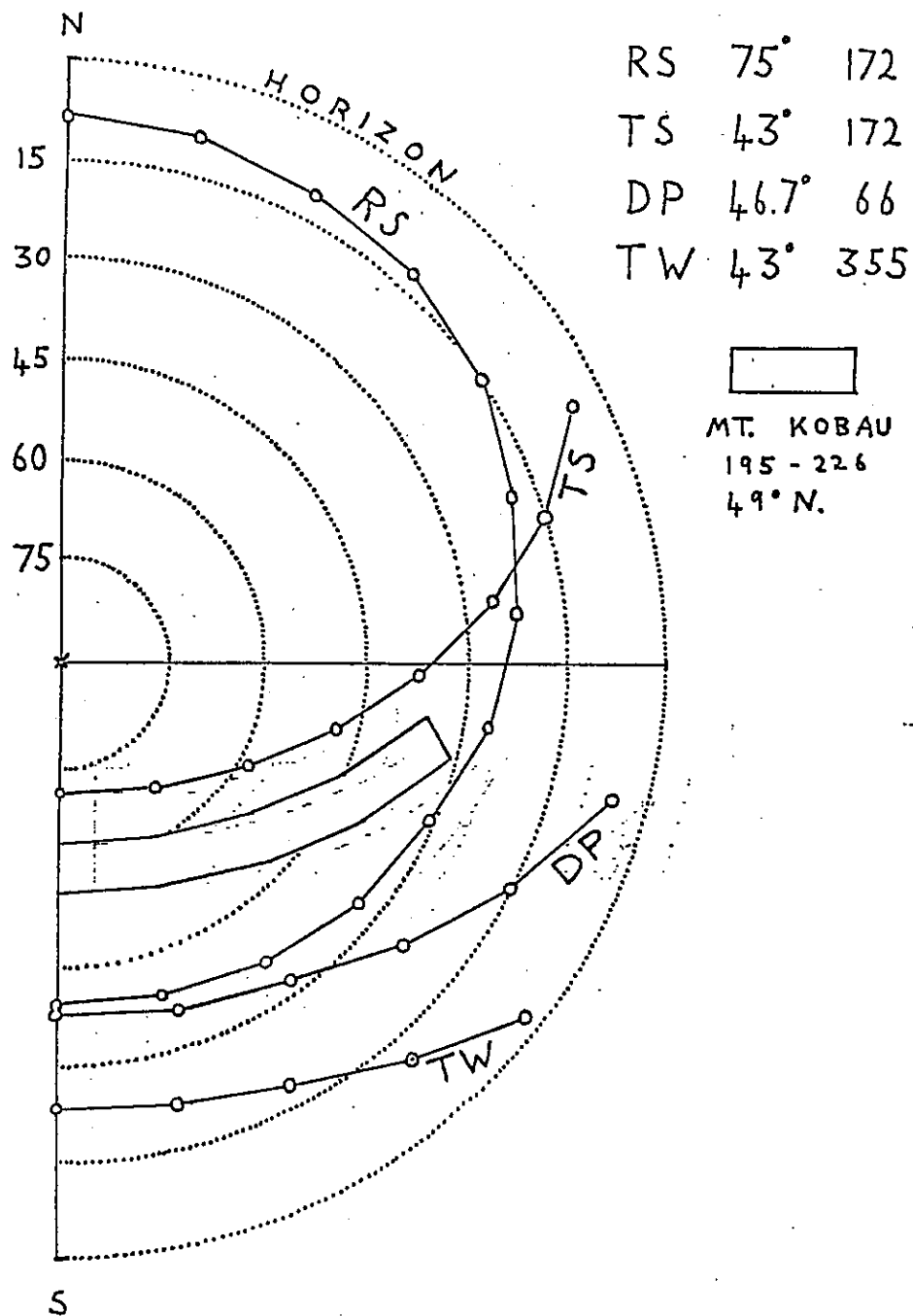

Figure K-3 The NARC specification of pyranometer sensitivity has been developed primarily for the Canadian radiation network, which covers a very wide range of latitudes. The NARC specification is based on measurements at Mt. Kobay during July on clear days and this diagram shows the range of solar positions then. Also shown are the solar positions at hourly intervals at Resolute in summer (RS) and at Toronto in summer and in winter (TS & TW). The solar positions at Davos on the day of the comparison (Julian day 66) are indicated as DP.

CALIBRATION OF SCHENK PYRANOMETER 525 BY REFERENCE TO
 ABBOT PYRANOMETER T1 MOUNT KOBANU 1980

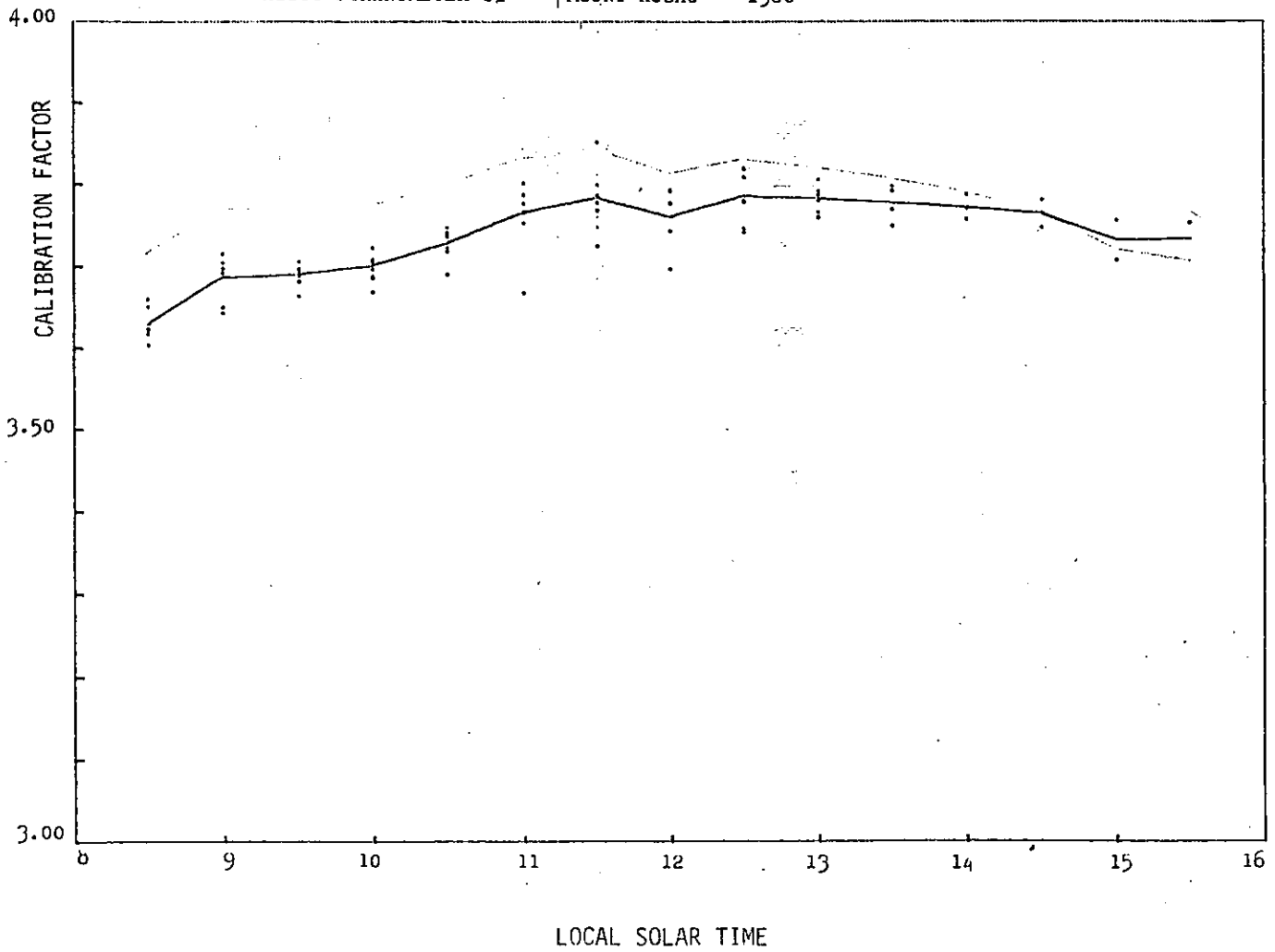

Figure K-4 Mt. Kobau calibration of Schenk #525. Note that the morning values are as much as 3% less than the afternoon ones. Later laboratory measurements identified this caused by a 1.5° tilt of the sensor with respect to the instrument body.

CALIBRATION OF KIPP AND ZONEN PYRANOMETER 75-2950 BY REFERENCE
TO ABBOT PYRANOMETER T1 MOUNT KOBALU B.C. 1950

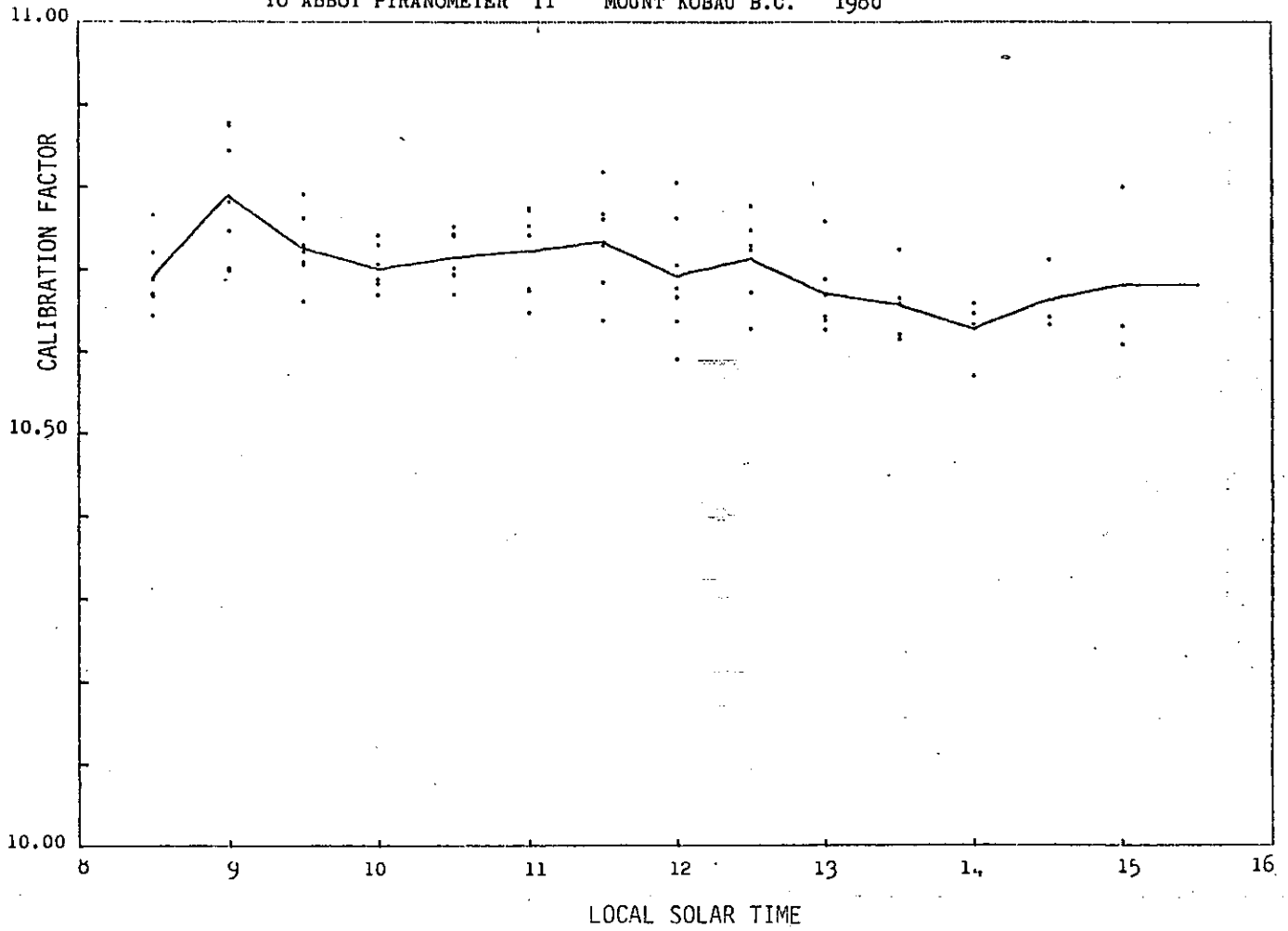

Figure K-5 Mt. Kobalau calibration of Kipp #75-2950. Each point represents a 30 minute integration on any of seven days. Note the total spread of about 2½%.

CALIBRATION OF EPPLEY MODEL #2 PYRANOMETER SERIAL 11667 BY
REFERENCE TO ABBOT PYRANOMETER T1 MOUNT KOBAN 1980

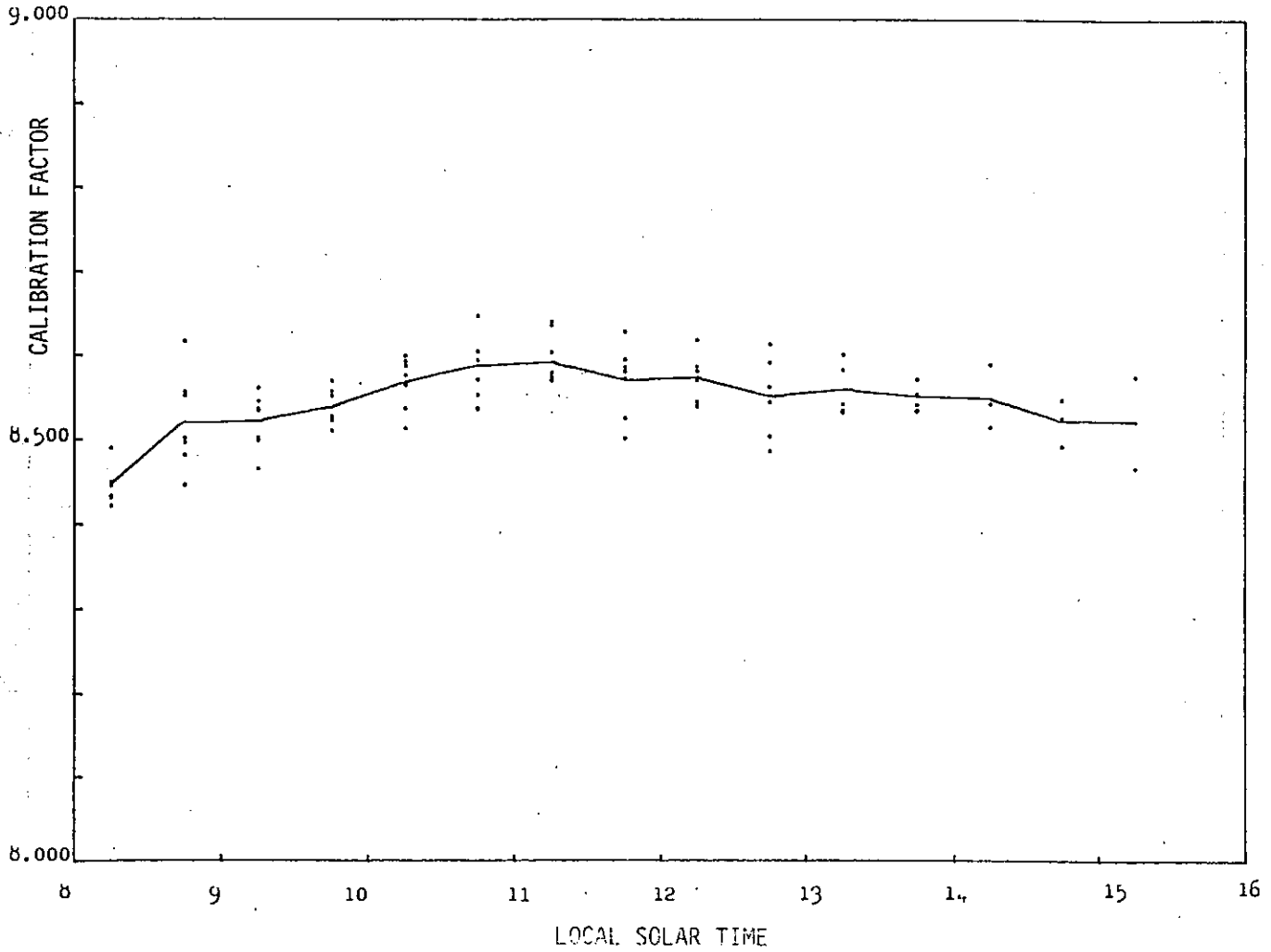

Figure K-6 Mt. Koban calibrations of Eppley #11667 by reference to the Abbot pyranometer.

CALIBRATION OF EPPLEY MODEL #2 PYRANOMETER SERIAL 11667 BY
OCCULTING. REFERENCE NIP IS EPPLEY #4538. MOUNT KOBAN 1978 & 1979

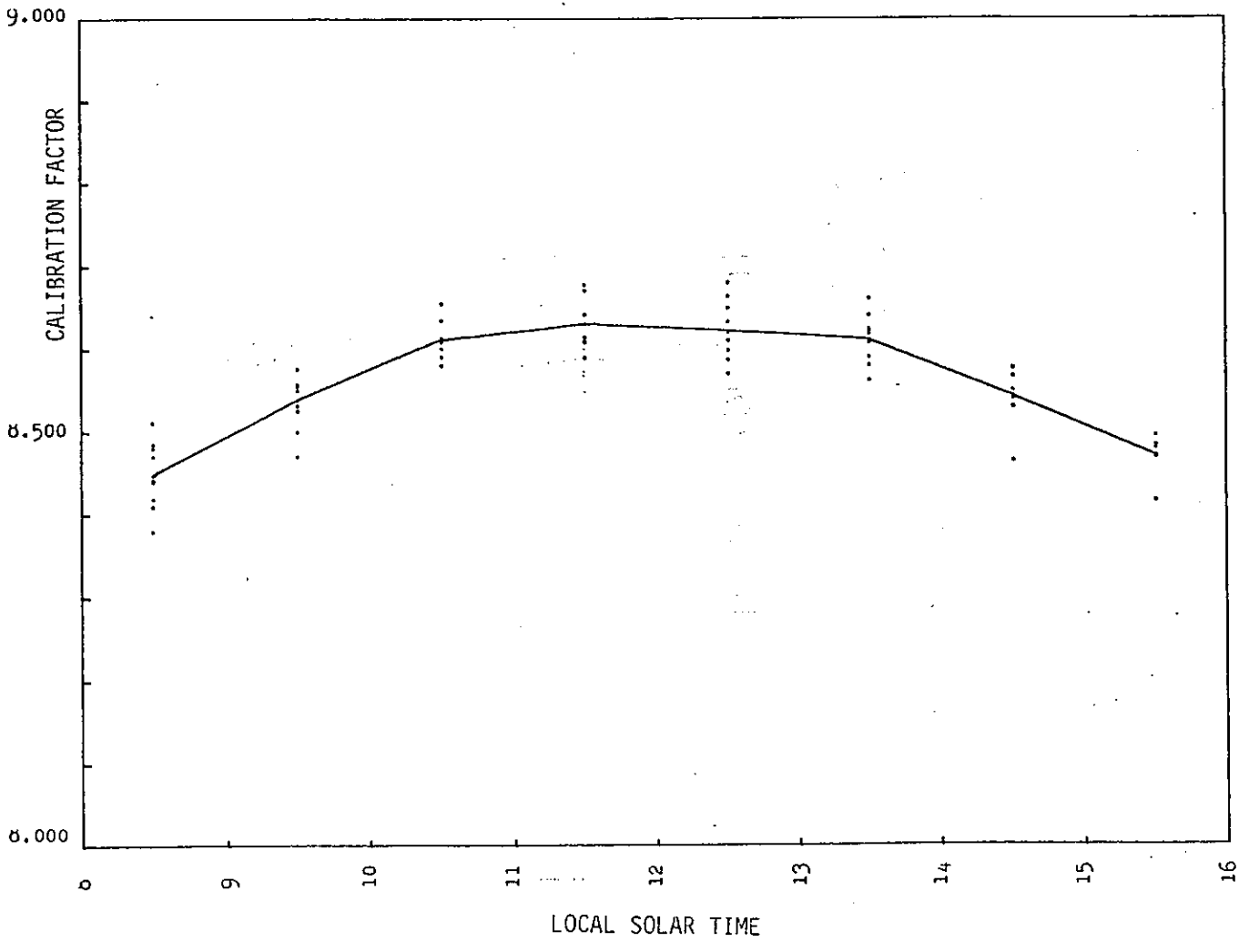
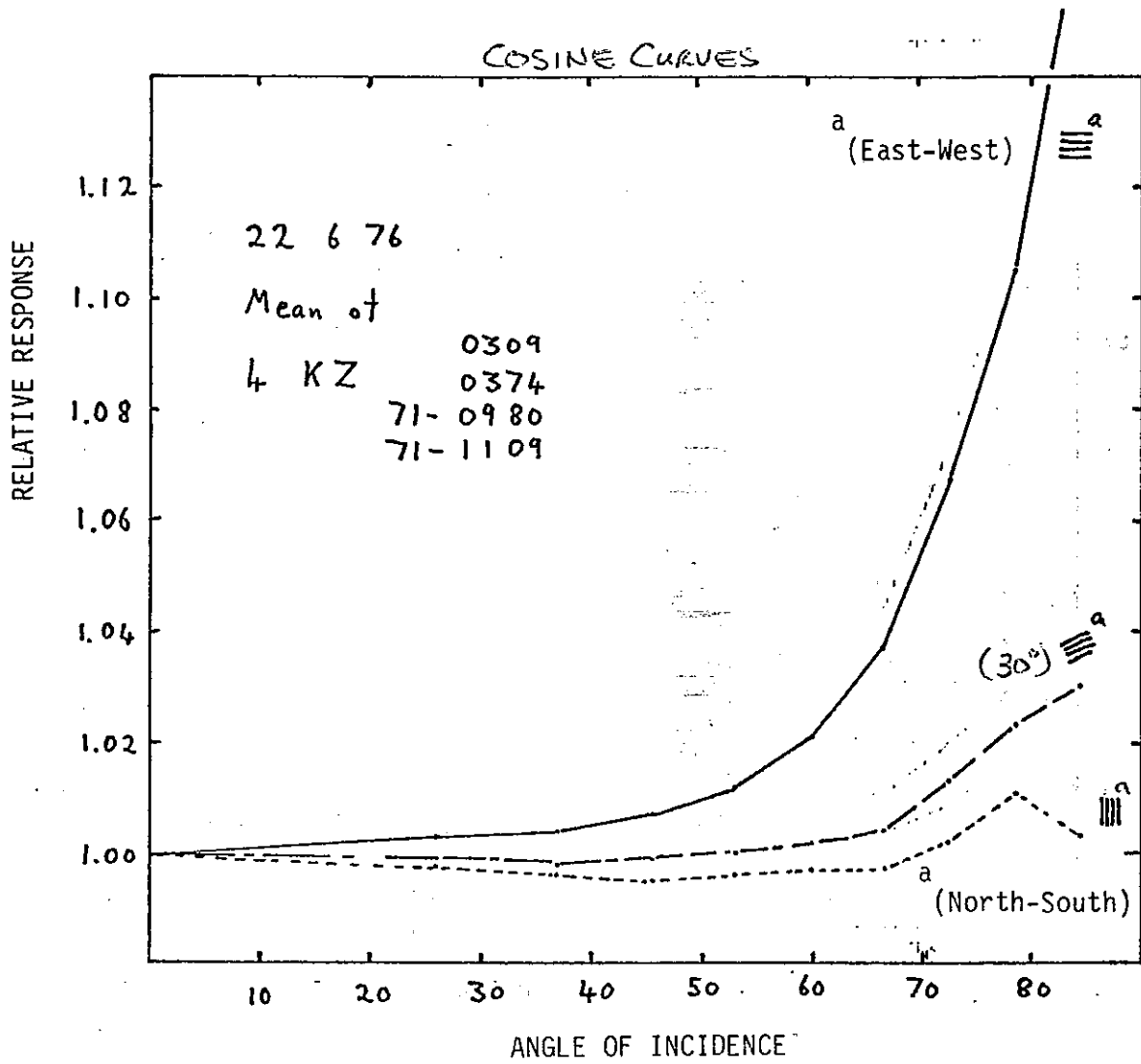

Figure K-7 Mt. Kobau calibrations of Eppley #11667 by occultation.

Figures 8, 9, 10

Laboratory measurements of the departure from the ideal response as a function of incidence angle. Note that the 1978 and 1975 groups are essentially similar while the earlier group is much worse. By interchanging the dome assemblies on early and later instruments one can show that the difference is due entirely to the seated height of the dome.



a
Thermopile Orientation

Figure K-8

COSINE CURVES.

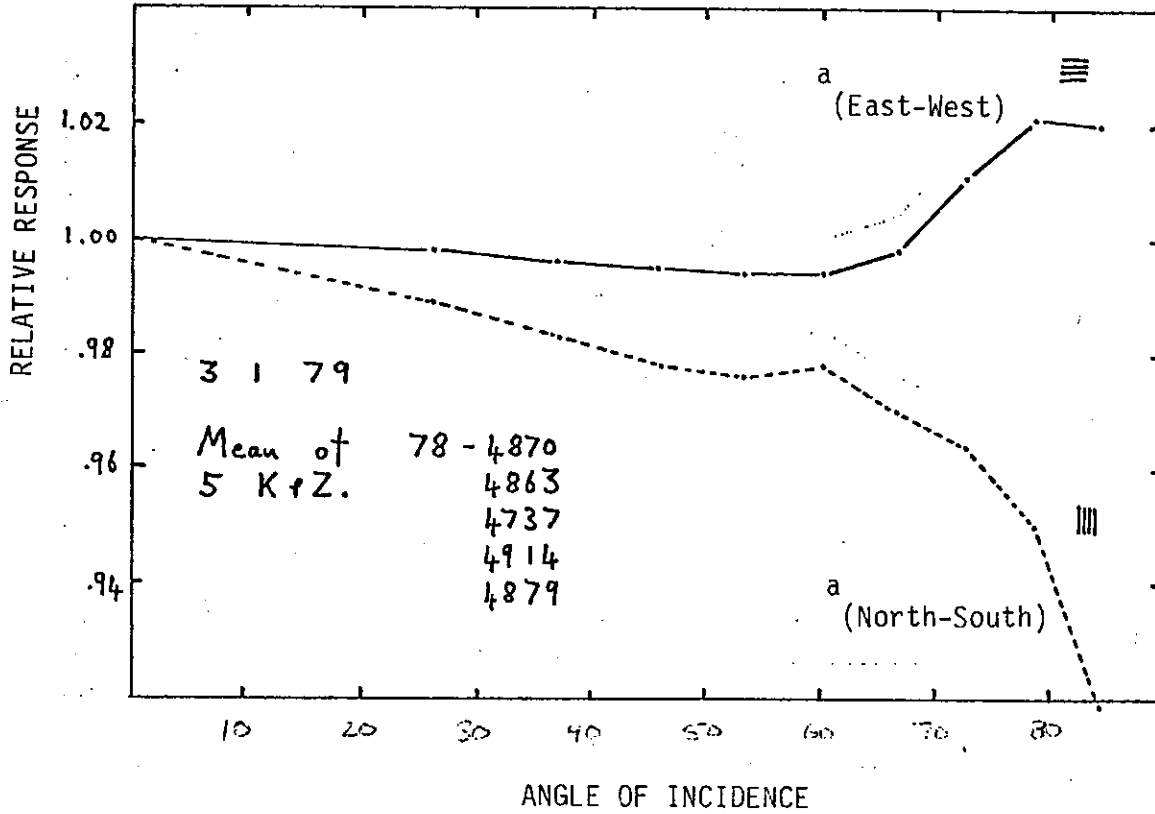

a
Thermopile Orientation

Figure K-9

COSINE CURVES

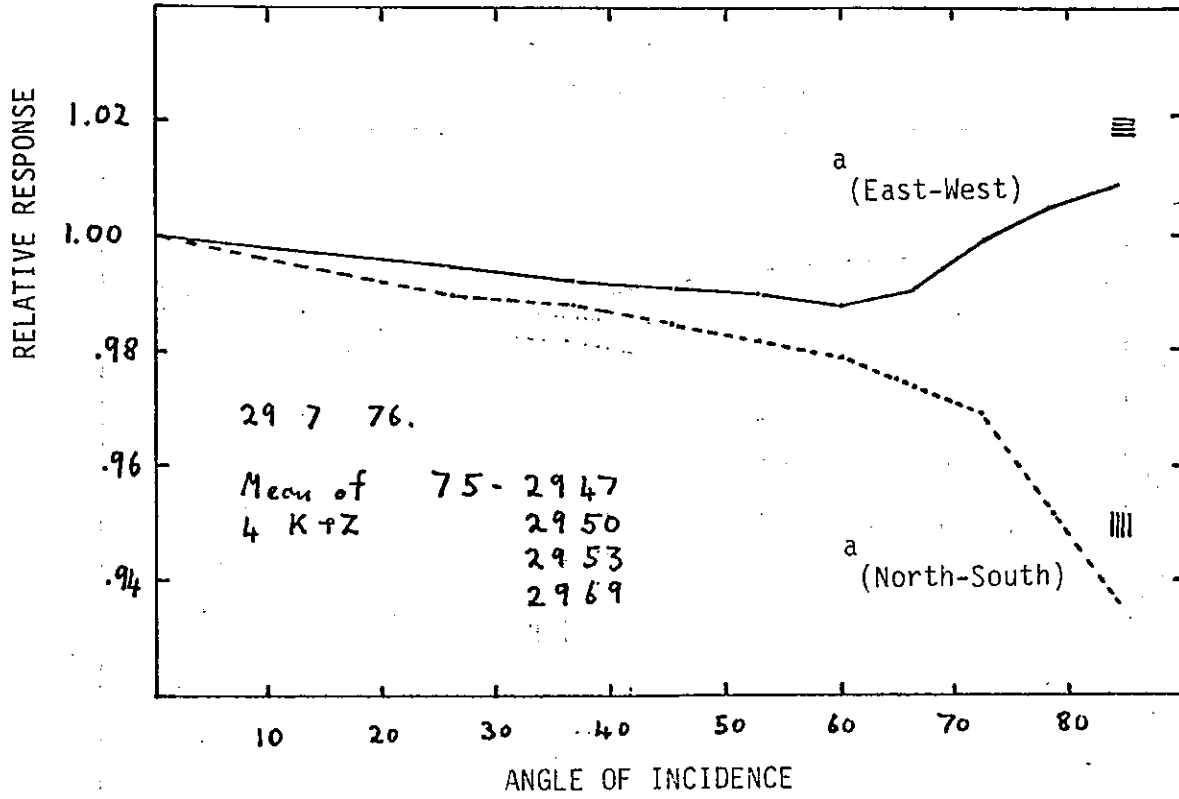

^a Thermopile Orientation

Figure K-10

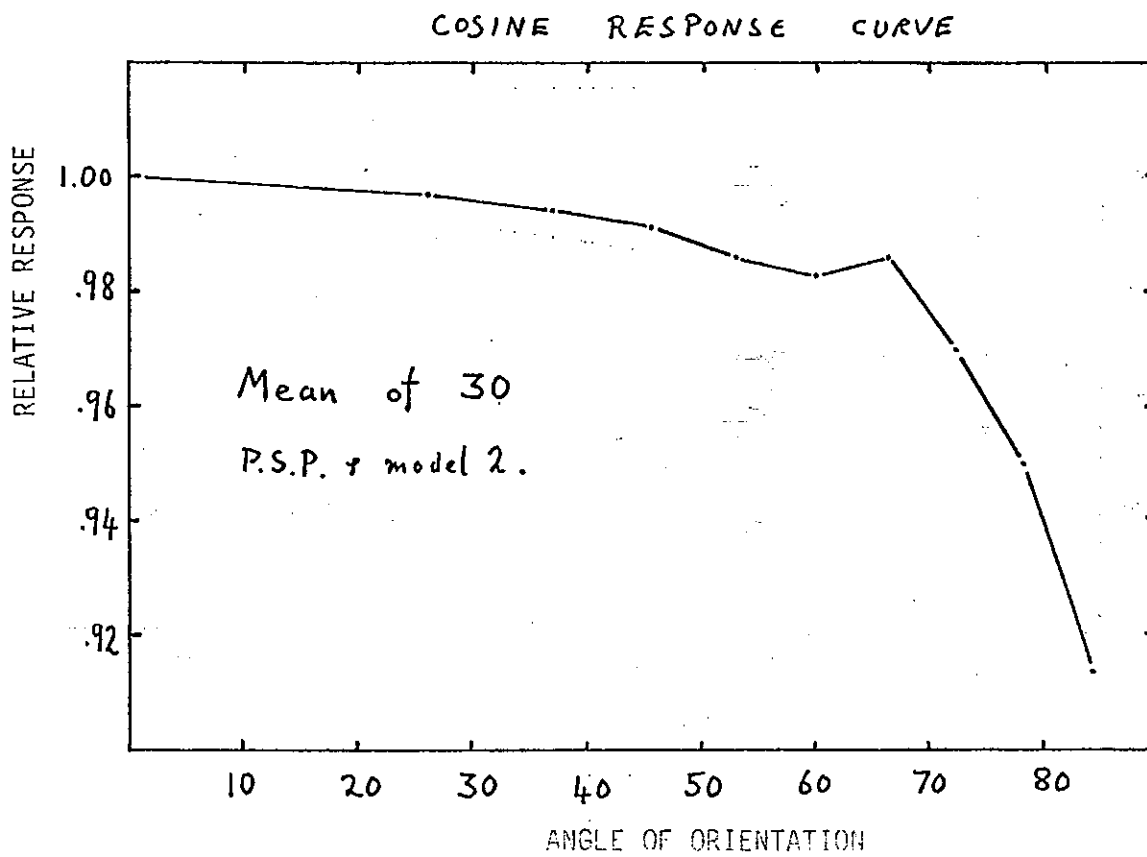

Figure K-11 Laboratory measurements of angular response of 30 Eppley PSP and model 2 pyranometers.

APPENDIX I

**Pyranometer Calibration Procedures at the
Canadian National Atmospheric Radiation Centre**

by

David Wardle
National Atmospheric Radiation Centre
Atmospheric Environment Service
4905 Dufferin Street
Downsville, Ontario M3H-5T4
Canada

Pyranometer Calibration Procedures at the Canadian National Atmospheric Radiation Centre

A Short Description for I.E.A. Task III and Task V

Standards

The primary standard for atmospheric radiation measurement in Canada is derived from a group of pyrhemometers including Abbot silver disc pyrhemometers, Angstrom pyrhemometers, and two absolute cavity radiometers. These are intercompared regularly during annual visits to Mt. Kobau in British Columbia, and at least one of them has been present at all WMO-IPC comparisons.

Radiation Scales

Since 1960 the IPS (1956) as defined by the Smithsonian Scale of 1913 - 2% has been the Canadian Reference. As maintained by NARC since 1970 (and as distinct from the other definition of IPS based on the Angstrom Scale) this scale can be demonstrated as identical to the new World Radiometric Reference to within 0.3% or less.

Reference Pyranometers

A group of ten or so reference pyranometers are calibrated from the standard pyrhemometers on a two-year schedule at Mt. Kobau, usually in July. The transfer is made both by occultation and via two Convertible Abbot pyranometers.

Sphere Calibration

The calibration procedure for the two hundred or so pyranometers that pass through NARC each year is by the sphere method. The signal from the pyranometer under test is compared with those from one or two reference pyranometers of like manufacture while all are inside a six-foot diameter diffusing sphere in the laboratory.

Other Regular Tests

- (i) The temperature coefficient of response is measured on every tenth pyranometer.
- (ii) Unless there is special reason not to do so, the pyranometer is adjusted so that the direction of maximum sensitivity is vertical.

Some Comments on Accuracy and Reproducibility

- (i) The definition of sensitivity of a non-Lambertian pyranometer requires (but seldom receives) care in formulating. Essentially, we take a mean on each sunny day in July at the Mt. Kobau site during the four hours on either side of local solar noon. As such, the numbers reproduce within the total range of 2%.

- (ii) The two distinct transfer methods from pyrheliometer to pyranometer agree to 0.5% rms.
- (iii) The relation between laboratory sphere calibration and field calibration depends on individual instruments. For example, the difference with Eppley model 2s and P.S.P.s is usually small but occasionally can be as much as 2%. A similar discrepancy would result if a CM-6 were calibrated in the sphere against P.S.P.s.
- (iv) The error in the absolute calibration by the sphere method with the definition (or perhaps caveat) is, in light of the above uncertainties and others, considered to be 3% or less.
- (v) The reproducibility and stability of the sphere method can be estimated from the following. In a sample of 244 cases of two or more calibrations separated by two years or more being done on the same instruments, 69% exhibited a change of less than 0.5%.
- (vi) Agreement with manufacturers' calibrations. It is assumed that both manufacturers use the IPS Angstrom scale which differs by 2.2% (IPC IV) from the WRR which (see above) is already the scale used by NARC. Thus, one should expect

$$\frac{\text{Manufacturer's sensitivity}}{\text{NARC sensitivity}} = 1.022.$$

The actual situation is that the Kipp values since 1973 have been in serious disagreement.

KIPP/NARC			EPPLEY/NARC		
1971-73	1.017 ± .013	(75)	69-75	1.029 ± .008	(53)
1976-78	1.076 ± .011	(22)	76-78	1.035 ± .019	(16)
1979-80	1.076 ± .010	(18)	79-80	1.038 ± .011	(40)

D. I. Wardle
2/2/81

APPENDIX M

**Preliminary Analysis of IEA Pyranometer Performance Comparisons:
An Outdoor Tilt Table Study**

by

Thomas L. Stoffel
Solar Energy Research Institute
1617 Cole Boulevard
Golden, Colorado 80401
U.S.A.

M.1 INTRODUCTION

Following the calibration comparisons at Canada's Atmospheric Environment Service, National Atmospheric Radiation Center (AES/NARC) and the U.S. National Oceanic and Atmospheric Administration's Solar Radiation Facility (NOAA/SRF), the first of two groups of IEA pyranometers involved in Round Robin II were installed on 2 March 1981 at the Solar Energy Research Institute's Insolation Research Laboratory (SERI/IRL). Table M-1 shows the two additional reference instruments from SERI and NOAA/SRF involved in this experiment. The purpose of the experiment was to evaluate the relative abilities of these instruments to measure the global radiation available to south-facing, inclined surfaces. Specifically, the radiation measurements would be representative of the type required for solar collector performance tests, i.e., a single calibration factor for each pyranometer would be applied to the voltage output from the instrument. The result from eleven pyranometers simultaneously positioned at various inclines during a single day of outdoor radiation measurement are presented.

Table M-1. Pyranometers Involved in SERI Tilt Table Experiments

Serial Number	Cal Factor ^a ($\mu\text{V}/\text{Wm}^{-2}$)	Owner
<u>Kipp & Zonen (CM6)</u>		
75-2438	10.96	Stuttgart F.R.G.
77-4120	13.33	Jülich F.R.G.
78-4750	11.23	Belgium
80-7177	10.48	Cardiff U.K.
<u>Eppley (PSP)</u>		
14806F3	9.91	National Bureau of Standards, U.S.A.
14861F3	9.08	NOAA/SRF, U.S.A.
15834F3	8.97	Sweden
16692F3	9.72	Denmark
17750F3	9.55	National Research Council, Canada
17823F3	8.99	Jülich F.R.G.
17860F3	7.91	SERI, U.S.A.

^aAs determined recently by E. Flowers, NOAA/SRF

M.2 APPARATUS

Eleven (11) pyranometers were installed on a "tilt table" at the SERI/IRL outdoor facility (see Figure M-1). The table design permits up to twelve radiometers to be aligned side-by-side and tilted simultaneously to a

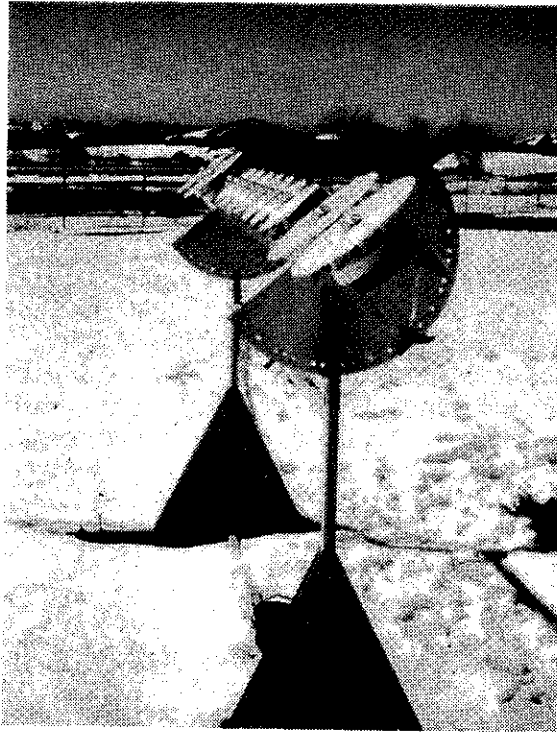

Figure M-1. Photograph of Tilt Table Apparatus Positioned for South-Facing 40° Tilt

predetermined angle from the horizontal with an accuracy of one degree and a precision of one-half degree. For this experiment, the tilt table was positioned with the instruments along an east-west line permitting south-facing measurements. The overall dimensions of this tilting fixture are nominally: 1.2 m high x 3.0 m long x 1.52 cm wide (at the point of pyranometer attachment). The tilt table is constructed of aluminum alloy and is neither painted nor anodized. Each pyranometer was adjusted to a uniform height above the plane of the table and leveled using its own spirit level and with the table horizontal (0 degree tilt). Coincident monitoring of the direct normal and global horizontal radiation was available from an Eppley Normal Incidence Pyrheliometer (NIP) and a Precision Spectral Pyranometer (PSP) mounted 10 m to the north of the tilt table and 3 m above the ground level on the roof of the data acquisition building. The data acquisition system utilizes a group of 12-bit analog-to-digital converters which sample each data channel four times per second. One-minute averages of these samples were recorded on half-inch magnetic tape via an LSI-11/2 minicomputer.

M.3 PROCEDURE

The analysis presented here is limited to the clear-sky conditions encountered on 5 March 1981. The tilt table was adjusted on this day according to the following schedule:

Local Standard Time	Tilt Angle (Degrees from Horizontal)
Sunrise - 10:00	0 (horizontal)
10:01 - 11:00	20
11:01 - 12:00	40
12:01 - 13:00	60
13:01 - 14:00	90
14:01 - Sunset	0

Wind-drifted snow covered the ground throughout the day, decreasing in depth from 1 cm to 0.5 cm and ranging from 100% ground coverage to approximately 60% of the ground area viewed by the instruments during the 90-degree tilt angle (Figure M-2). Figure M-3 shows a history of 15-minute average temperatures. No temperature corrections were applied to the irradiance measurements reported for this experiment.

M.4 ANALYSIS

Instrument calibration factors as derived by NOAA/SRF and available in March 1981, were used to compute the recorded one-minute averaged irradiance as measured by the 11 pyranometers on the tilt table, the global horizontal pyranometer, and the normal incidence pyr heliometer. Figure M-4 presents a time series plot of the latter two measurements. For comparison purposes, the SERI/IRL pyranometer (Eppley PSP s/n 17860F3) was arbitrarily selected as the reference instrument on the tilt table. Figure M-5 shows the irradiance measured with this instrument as the tilt table was adjusted during the day.



Figure M-2. Simulated Pyranometer Field of View Corresponding to 90° Tilt Using 8-mm Fisheye Camera Lens in the Plane of the Detector. Photo Taken 5 March 1981, 14:00.

5 March 1981

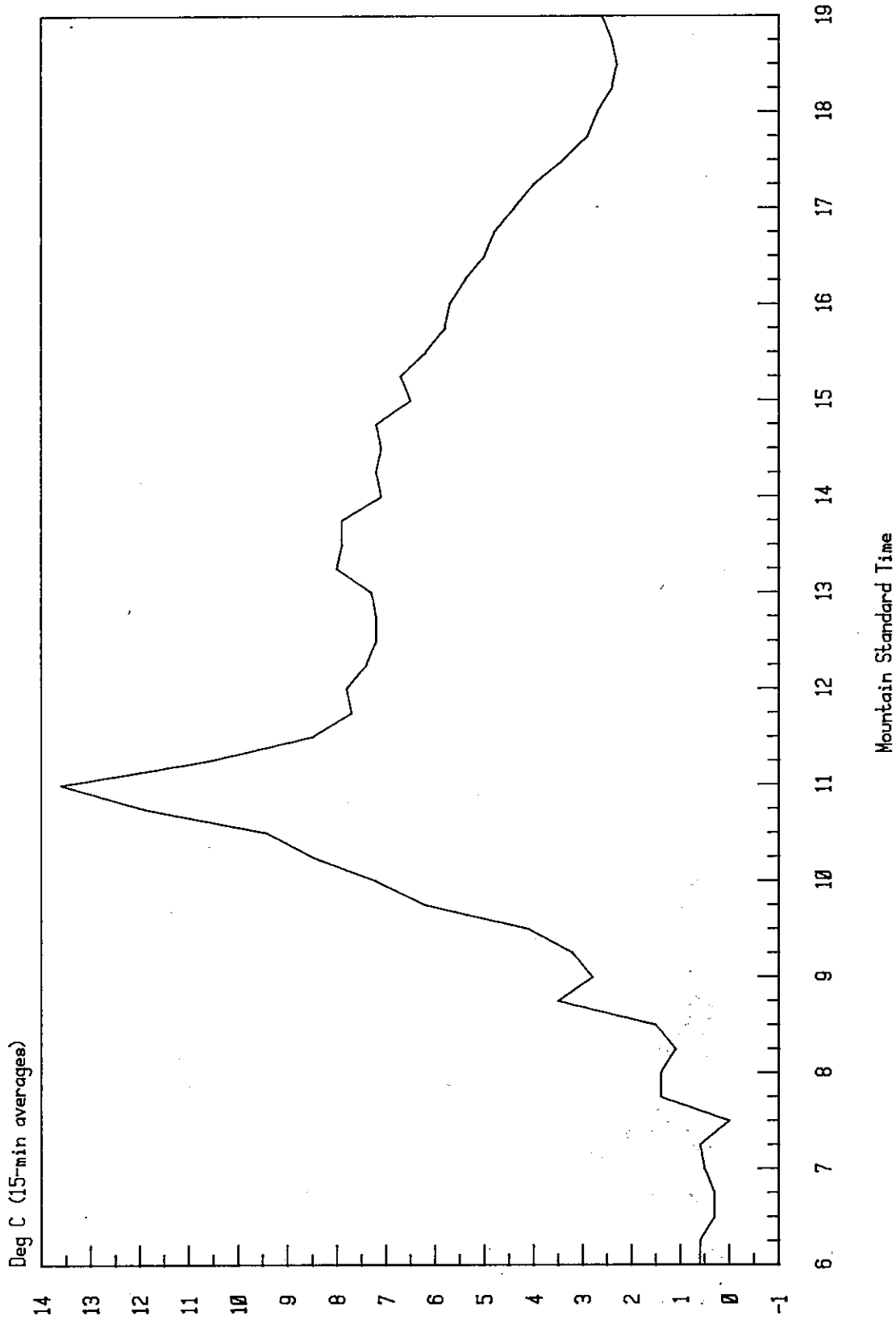

Figure 3. Ambient Air Temperature Profile for the Day of the Tilt Table Experiment

IEA Pyranometer Comparisons
Direct Normal & Global Horizontal 1-min Averages
Irradiance ($W/eq\ m$)

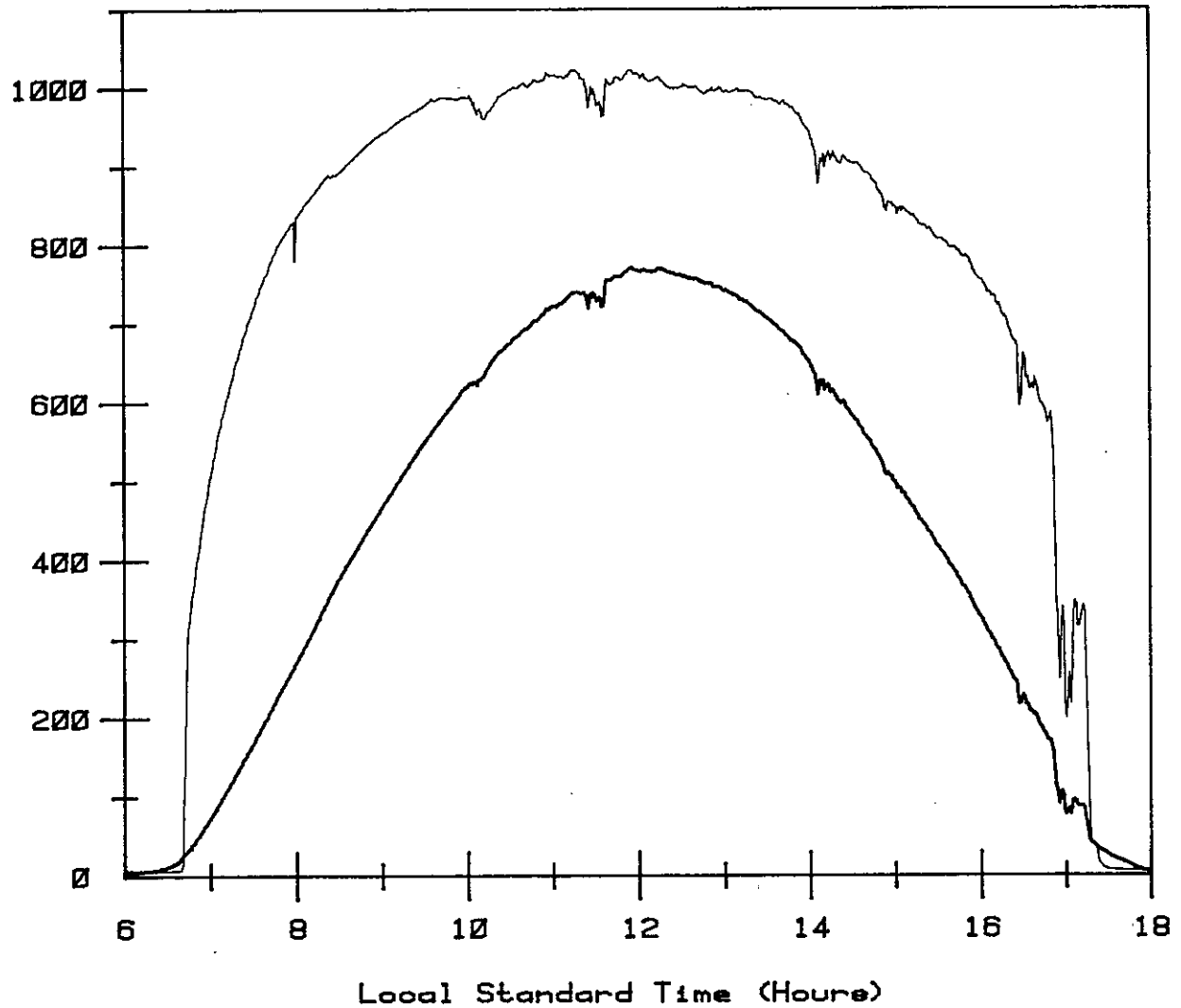

Figure 4. Time Series Plot of the Direct Normal and Global Horizontal Solar Radiation Components for the Day of the Tilt Table Experiment

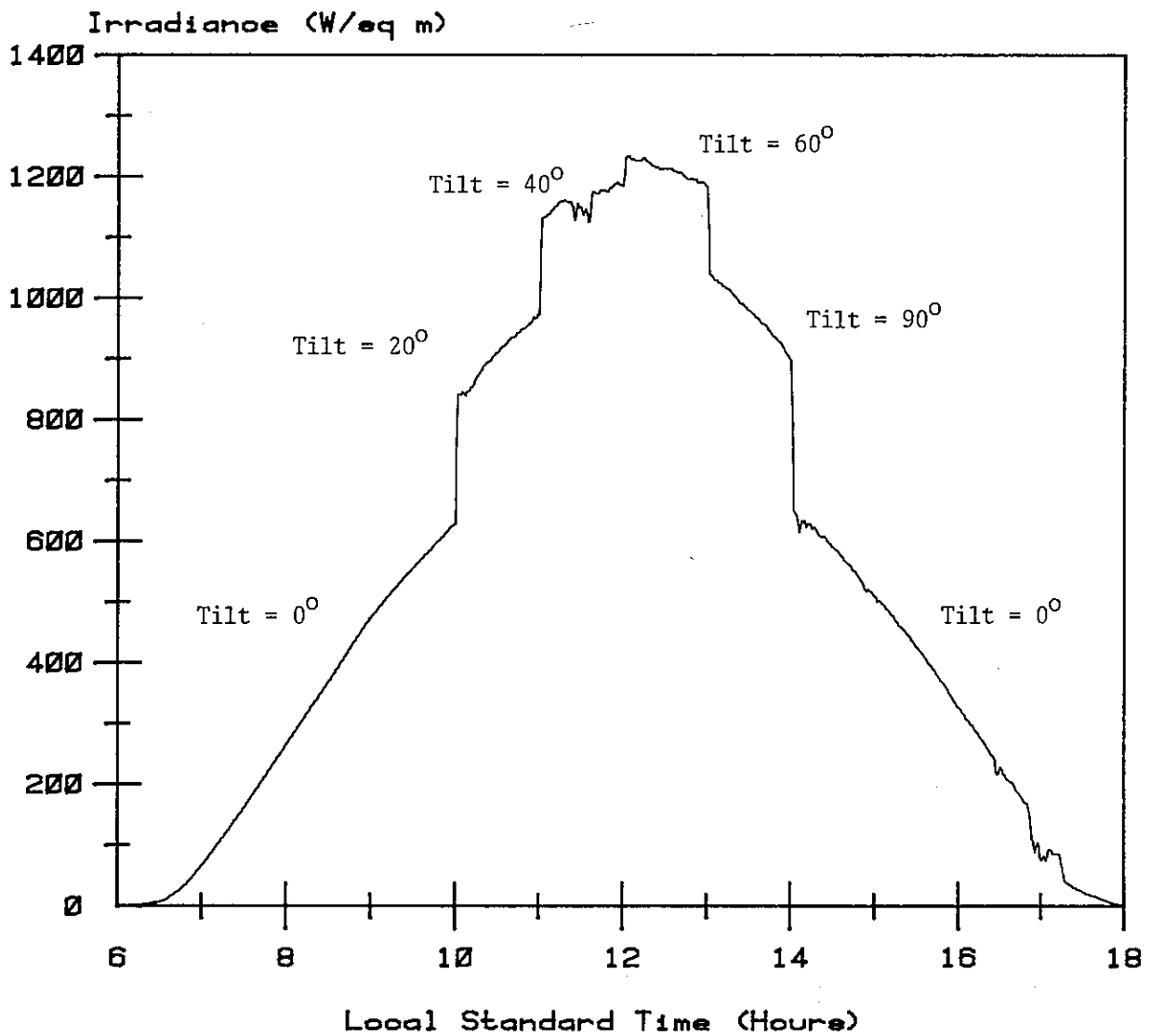

Figure 5. Global Irradiance on South-Facing Tilted Surfaces as Measured by SERI PSP 17860F3 Mounted on Tilt Table Fixture, 5 March 1982

The angle of incidence, defined as the angle formed by the sun's direct rays and the normal (zenith) to the sensor plane, changed with time of day and tilt angle (Figure M-6). A range of radiation intensities for similar angles of incidence was achieved as a result of changing the tilt angle during one day of measurements.

This preliminary analysis is limited to the relative comparisons of the measured irradiance values from the test instruments using the single calibration factor and the irradiance values from the SERI/IRL reference instrument.

Figure M-7 illustrates the relative measure of the Kipp and Zonen CM-6 instruments and the reference pyranometer. The irradiance ratios for this group of pyranometers during this comparison range from +1% to -12%, depending upon the instrument and angle of tilt. It should be noted that throughout the day of measurements KZ 77-4120 accumulated significant moisture on the inside surface of the outer hemisphere as a result of the snowfall during the previous day. Distinct droplets were visible over approximately 25% of the dome. The results presented here include all measurements as recorded for this instrument.

Figure M-8 presents the relative performance of the Eppley pyranometers with respect to the reference PSP. These plots show agreement to within $\pm 2\%$, independent of tilt angle.

This outdoor measurement of insolation on inclined surfaces combines the effects of cosine response, tilt effects, sensor leveling errors, and temperature coefficients. This is the result of comparing the performance of the instruments under test to a single reference pyranometer which itself has no special ability to qualify as an absolute measuring device for this experiment. No such device is commercially available.

The SERI/IRL pyranometer (EP 17860F3) has been calibrated recently using a shading disk technique. The resulting assigned calibration value agreed with the NOAA/SRF assignment to within 0.4%. No other characterizations of this instrument have been accomplished.

Figures M-7 and M-8 present results that are not absolute measures of the abilities of pyranometers to measure global irradiance on inclined surfaces, but they do indicate the relative precision of such measurements by several instruments exposed to identical tilt angles and a range of insolation levels.

Figure M-9 illustrates the variation of insolation intensity levels as a function of incidence angle. Irradiance levels in excess of 1000 watt/square meter were achieved for angles of incidence approaching 90 degrees.

Figure M-10 provides a summary of the variability over a longer time interval. These hourly averaged ratios of test/reference instrument performance indicate variations within an hour of 1% - 5% using one standard deviation from the mean.

Table M-2 presents a sample of individual one-minute averaged data according to instrument manufacturer. The last data value recorded before adjusting the tilt table was selected to compute the mean and standard deviation. This data

IEA Pyranometer Comparisons
Tilt Table DOY 64 1981

Angle of Incidence (From Detector Normal-Degrees)

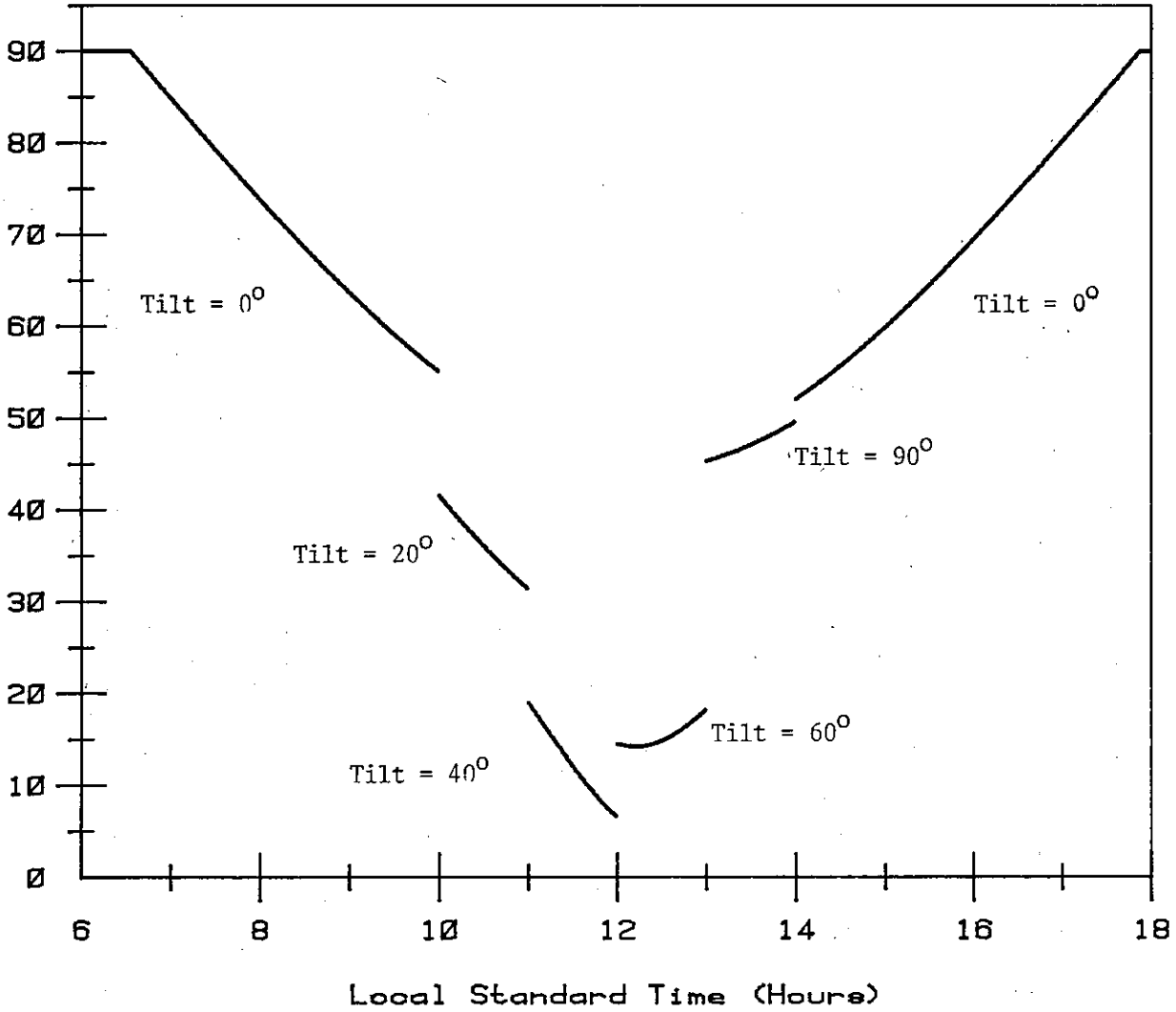

Figure 6. Time Series Plot of the Incidence Angle Showing Effects of Changing Instrument Tilt Within the Day

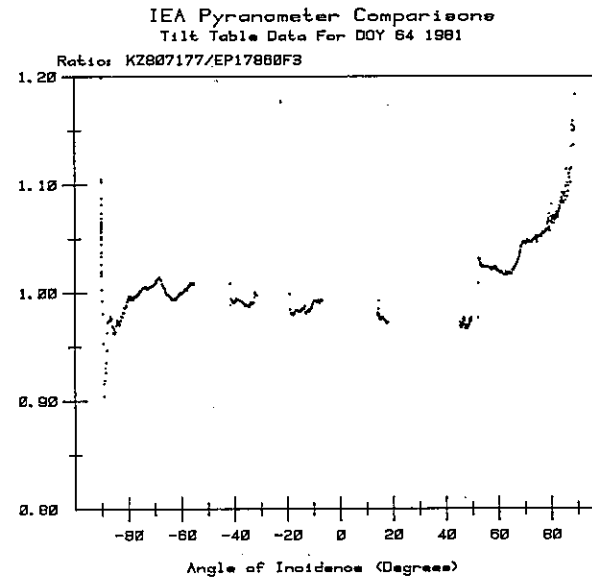
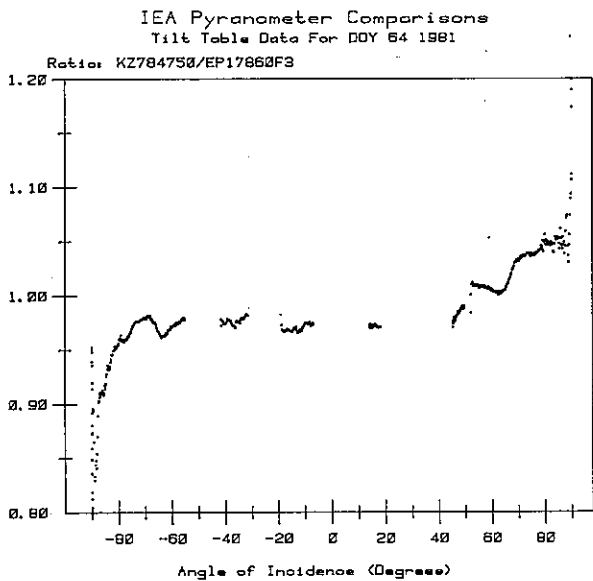
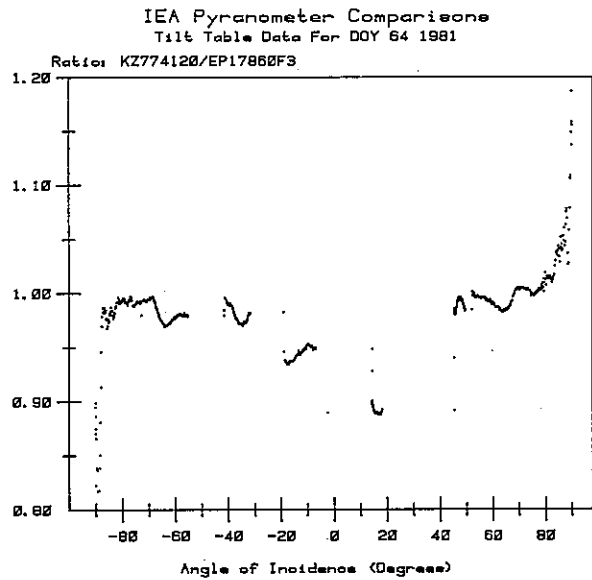
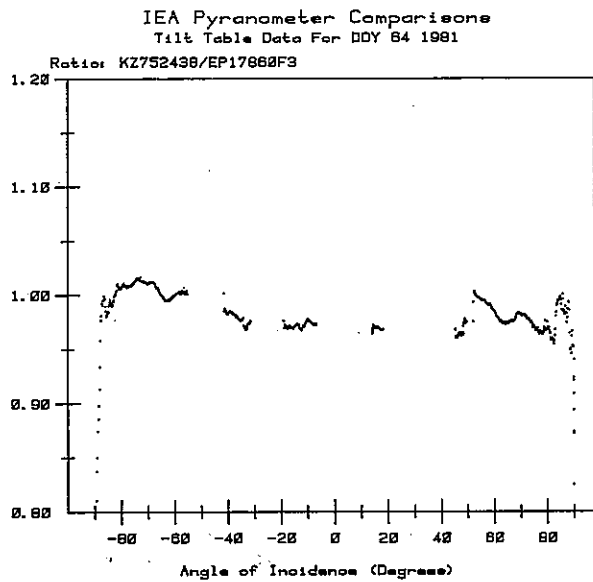

Figure 7. Comparisons of Four IEA Pyranometers (Kipp and Zonen CM-6) with SERI Reference Pyranometer (Eppley Laboratory Model PSP, s/n 17860F3) Using the Ratio of 1-minute Average Irradiance Measurements. Morning Values of Solar Incidence Angle with Respect to Sensor Normal are Negative; Afternoon Values are Positive.

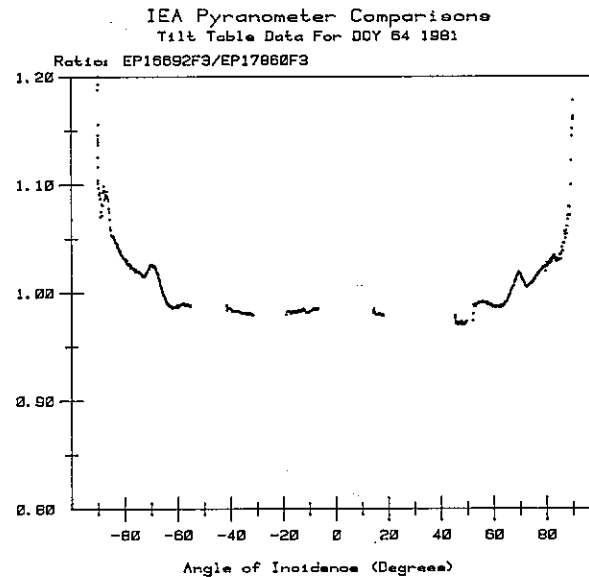
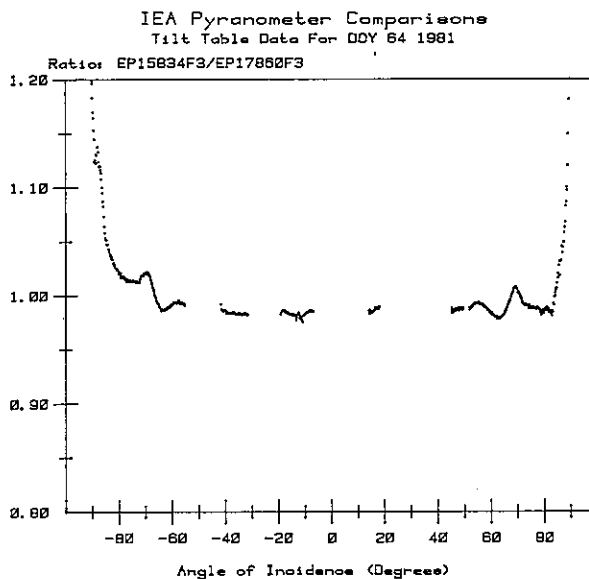
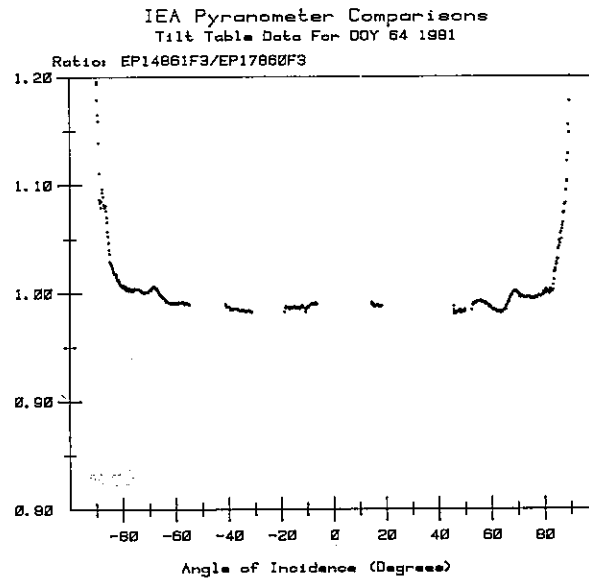
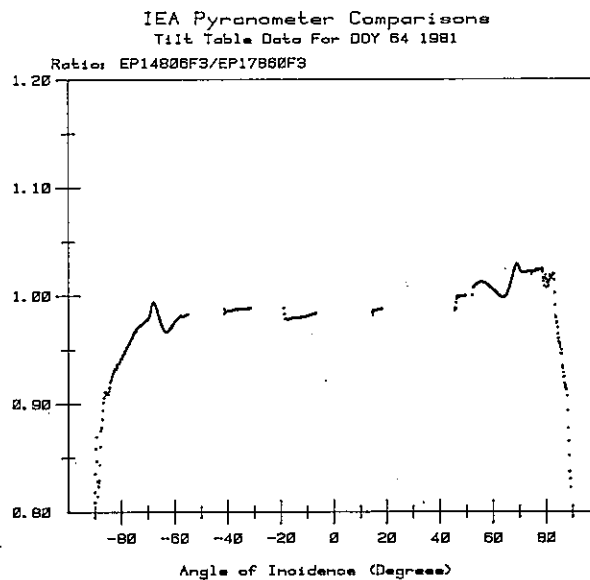

Figure 8. Comparisons of four IEA Pyranometers (Eppley Laboratory Model PSP) with SERI Reference Pyranometer (Eppley Laboratory Model PSP, s/n 17860F3) Using the Ratio of 1-minute Average Irradiance Measurements. Morning Values of Solar Incidence Angle with Respect to Sensor Normal are Negative; Afternoon Values are Positive

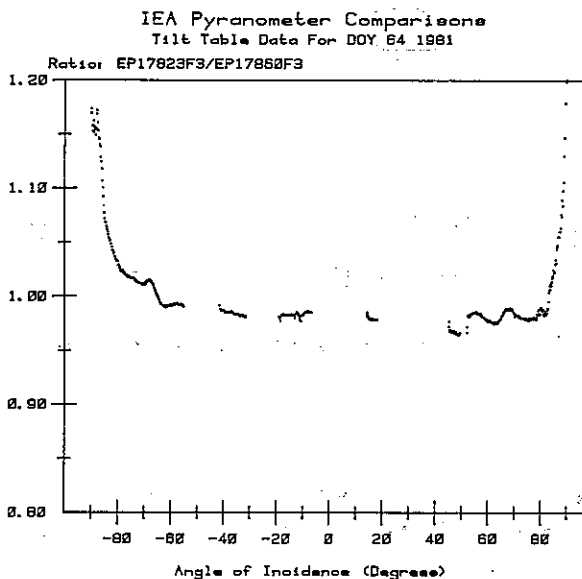
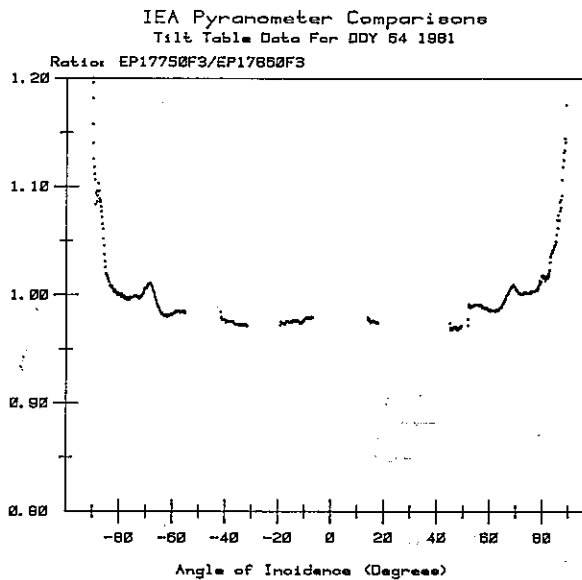

Figure 8. Comparisons of two IEA Pyranometers (Eppley Laboratory Model PSP) with SERI Reference Pyranometer (Eppley Laboratory Model PSP, s/n 17860F3) Using the Ratio of 1-minute Average Irradiance Measurements. Morning Values of Solar Incidence Angle with Respect to Sensor Normal are Negative; Afternoon Values are Positive (Concluded)

IEA Pyranometer Comparisons
Tilt Table Data For DOY 64 1981

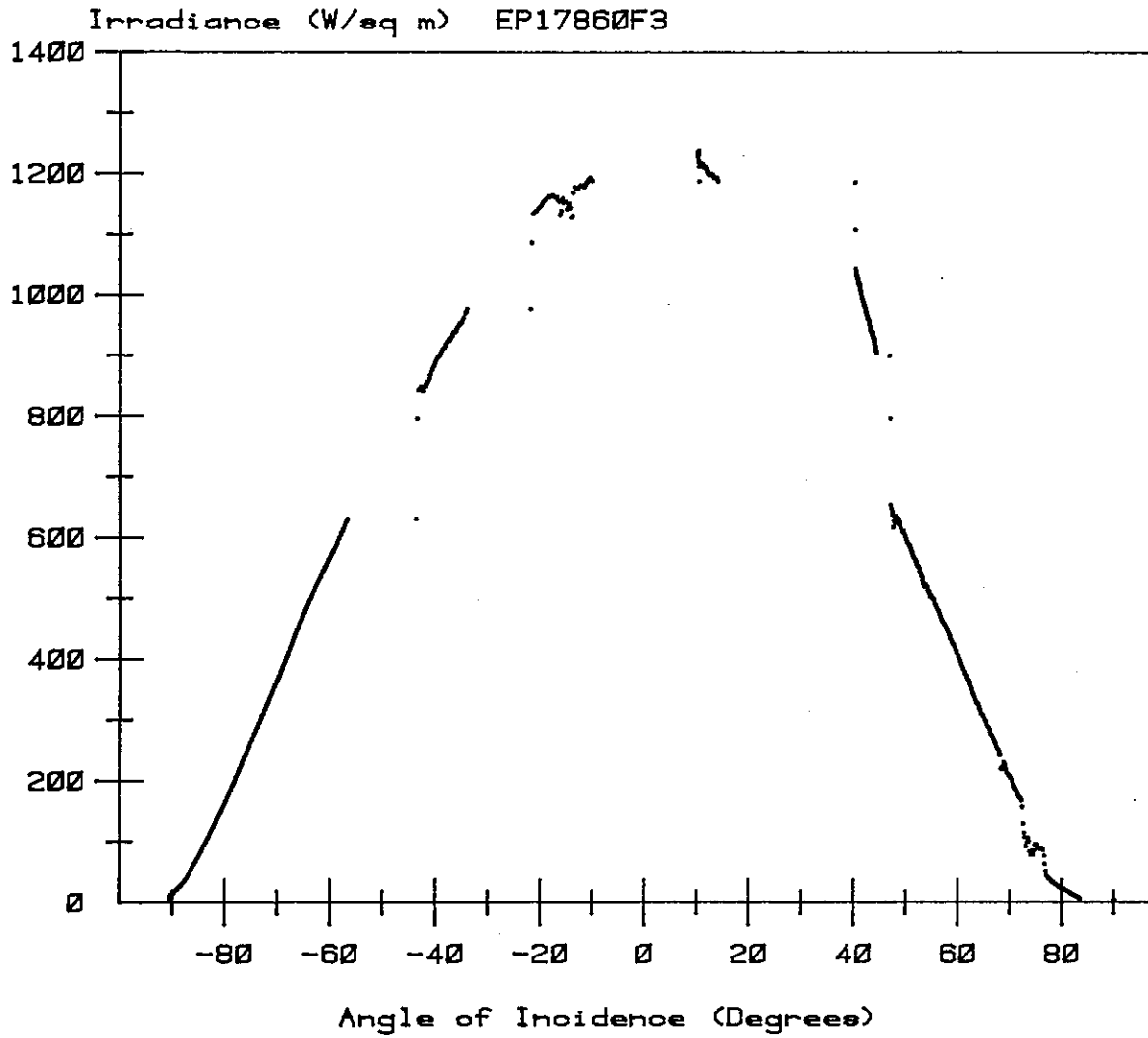
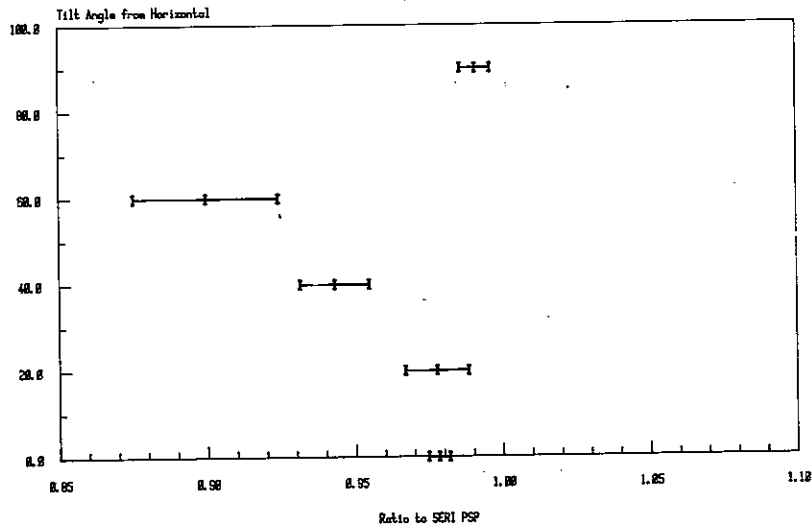

Figure 9. Variation of Irradiance as a Function of Incidence Angle. Note the Relatively High Values (1000 W/m^2) at Near-Grazing Angles (90°)

IEA Pyranometer Comparisons

DOY 64 1981 KZ774120 on tilt table



IEA Pyranometer Comparisons

DOY 64 1981 KZ784750 on tilt table

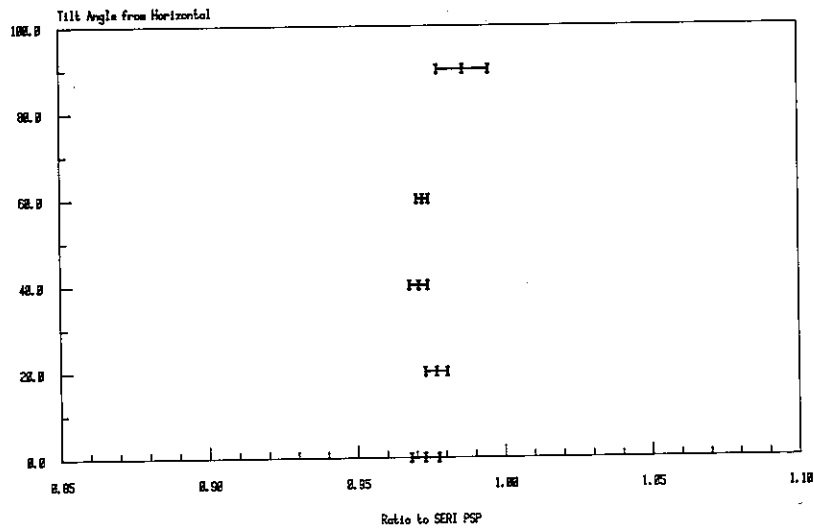
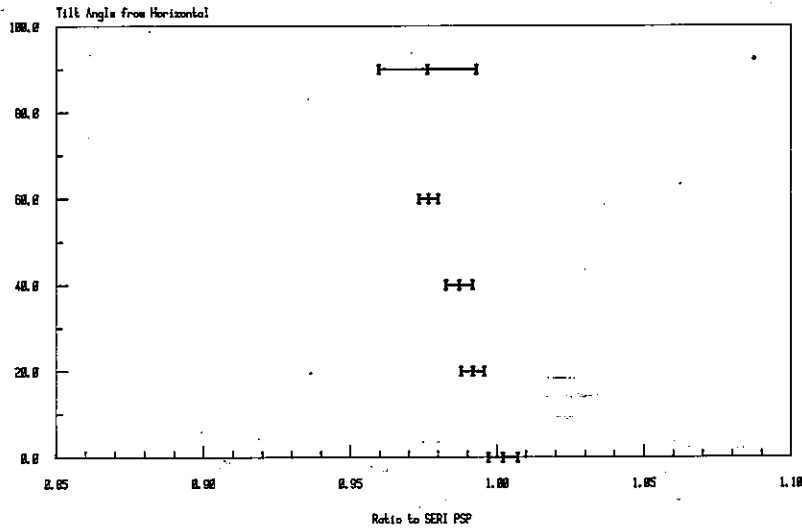

Figure 10. Solar Irradiance on Various South-Facing Tilts as Measured by SERI Reference Pyranometer as a Function of Incidence Angle. One-minute Averages Recorded on 5 March 1981

IEA Pyranometer Comparisons

DOY 64 1981 KZ887177 on tilt table



IEA Pyranometer Comparisons

DOY 64 1981 EP14861F3 on tilt table

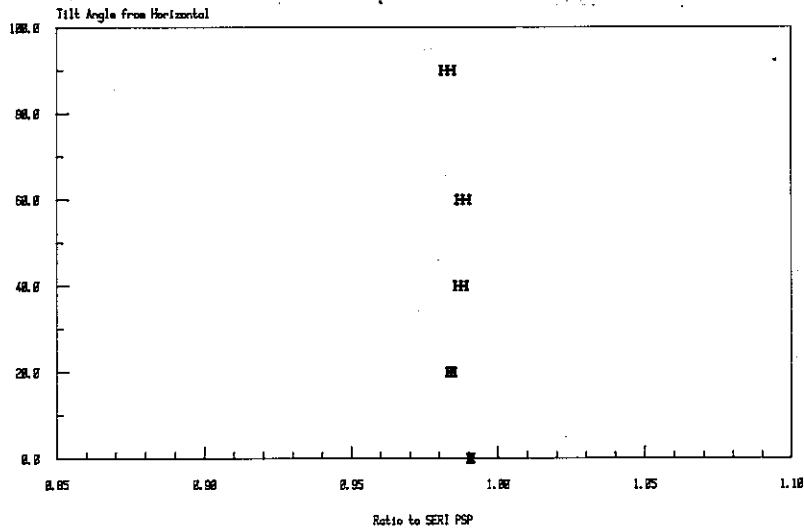
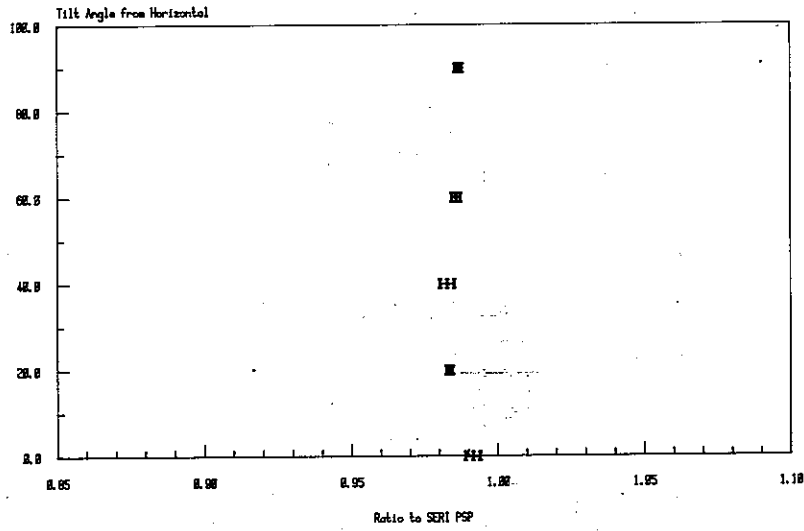

Figure 10. Solar Irradiance on Various South-Facing Tilts as Measured by SERI Reference Pyranometer as a Function of Incidence Angle. One-minute Averages Recorded on 5 March 1981 (Continued)

IEA Pyranometer Comparisons

DOY 64 1981 EP15834F3 on tilt table



IEA Pyranometer Comparisons

DOY 64 1981 EP17823F3 on tilt table

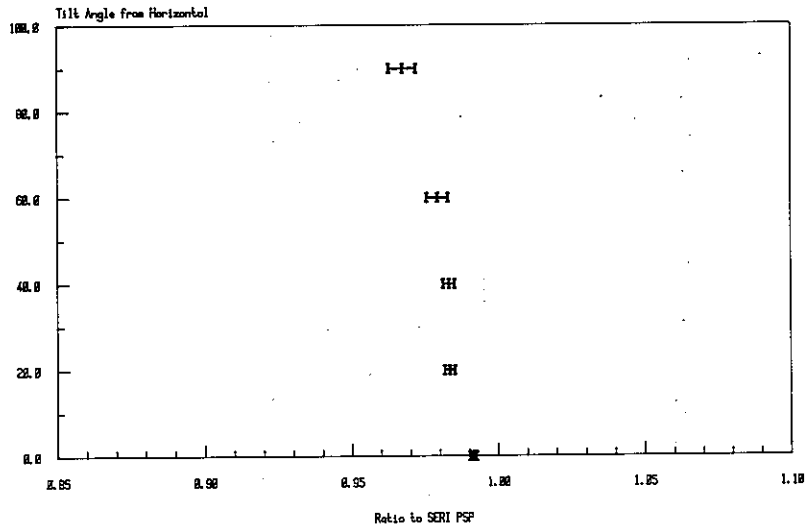

Figure 10. Solar Irradiance on Various South-Facing Tilts as Measured by SERI Reference Pyranometer as a Function of Incidence Angle. One-minute Averages Recorded on 5 March 1981 (Concluded)

Table M-2. Outdoor Tilt Table Measurements: Select 1-Minute Averages

Time	Tilt (Deg.)	Kipp & Zonen (4)			Eppley (7)			Combined (11)		
		Avg.	Std. D (%)	S/Avg.	Avg.	Std. D (%)	S/Avg.	Avg.	Std. D (%)	S/Avg.
09:00	0	469.3	7.81	1.66	472.4	5.06	1.07	471.3	6.01	1.28
10:59	20	958.0	9.31	0.97	957.0	8.74	0.91	957.4	8.49	0.89
11:59	40	1154.1	21.33	1.85	1171.0	7.76	0.66	1164.8	15.65	1.34
12:59	60	1131.9	47.77	4.22	1173.4	10.18	0.87	1158.3	34.42	2.97
13:59	90	893.8	6.89	0.77	895.8	13.05	1.46	895.1	10.84	1.21

Note: Data includes K&Z 77-4120 which had moisture inside the outer dome throughout the day of 5 March 1981.

summary shows that the typical procedure of applying a single calibration factor to the measured output voltage produced by the pyranometer during a solar collector performance test can produce irradiance values with a precision (repeatability) of $\pm 1\%$ to $\pm 3\%$, depending upon the tilt angle and manufacturer of the device.

Based upon these limited measurements, it should be apparent that more testing, both in controlled laboratory conditions and outdoor environments, is required to address the needs of the collector performance audience of pyranometer users. Hopefully, this work will be accomplished through the coordinated efforts of IEA members.

APPENDIX N

Some Li-Cor Characteristics

by

Valentine Szwarc
Solar Energy Research Institute
1617 Cole Boulevard
Golden, Colorado 80401
U.S.A.

Some Li-Cor Characteristics

Valentine S. Szwarc

Renewable Resource Assessment and Instrumentation Branch
Solar Energy Research Institute, Golden, CO USA
March 17, 1981

Characterization and performance comparisons of the Li-Cor pyranometer (LI-200sb) to thermopile instruments are becoming increasingly important because of the widespread use of the Li-Cor and similar instruments. The use of Li-Cors in SERI's Renewable Resource Assessment and Instrumentation Branch's mesoscale solar energy variability research has motivated studies to help understand and interpret the Li-Cor's performance within a mesoscale network. The results presented here are only preliminary, but suggest the need for further investigation which is being carried out by myself and others at SERI.

Figure N-1 is an example of the derived calibration of a Li-Cor instrument as a function of the time of day for two different days. Day 276 was partly cloudy and Day 279 was cloudless. The significance of Figure N-1 is the obvious difference of the Li-Cor calibration for the two days. Additional data that brings attention to the large daily difference of Li-Cor calibration constants is displayed in Figure N-2, which shows a comparison of daily calibration constants for five Li-Cors over a 24 day period. The Li-Cors tend to track each other over the period, however, on a number of days there is some additional variation that is inconsistent with the other instruments. Day 302 had snow and Day 313 was missing.

Figure N-3 has a 155 day record of calibration constants for one instrument. The Li-Cor shows increased sensitivity during the fall of 1980 and suggests an annual variation and possibly a long term trend of the calibration constant. The annual variation and long term trend were verified by plotting a year of data and correspondence with Edwin Flowers of NOAA, respectively. Also, the data displayed in Figure N-3 suggests calibration variations with frequencies on the order of weeks and months.

The Li-Cor variations outlined here can impact Li-Cor monitoring and measurement activities, and warrant further investigation and an understanding of of the Li-Cor's performance.

LAMBDA 10 MIN. CAL CONSTANTS VS TIME

INSTR. SN 1833 FOR DOY 79276 AND 79279

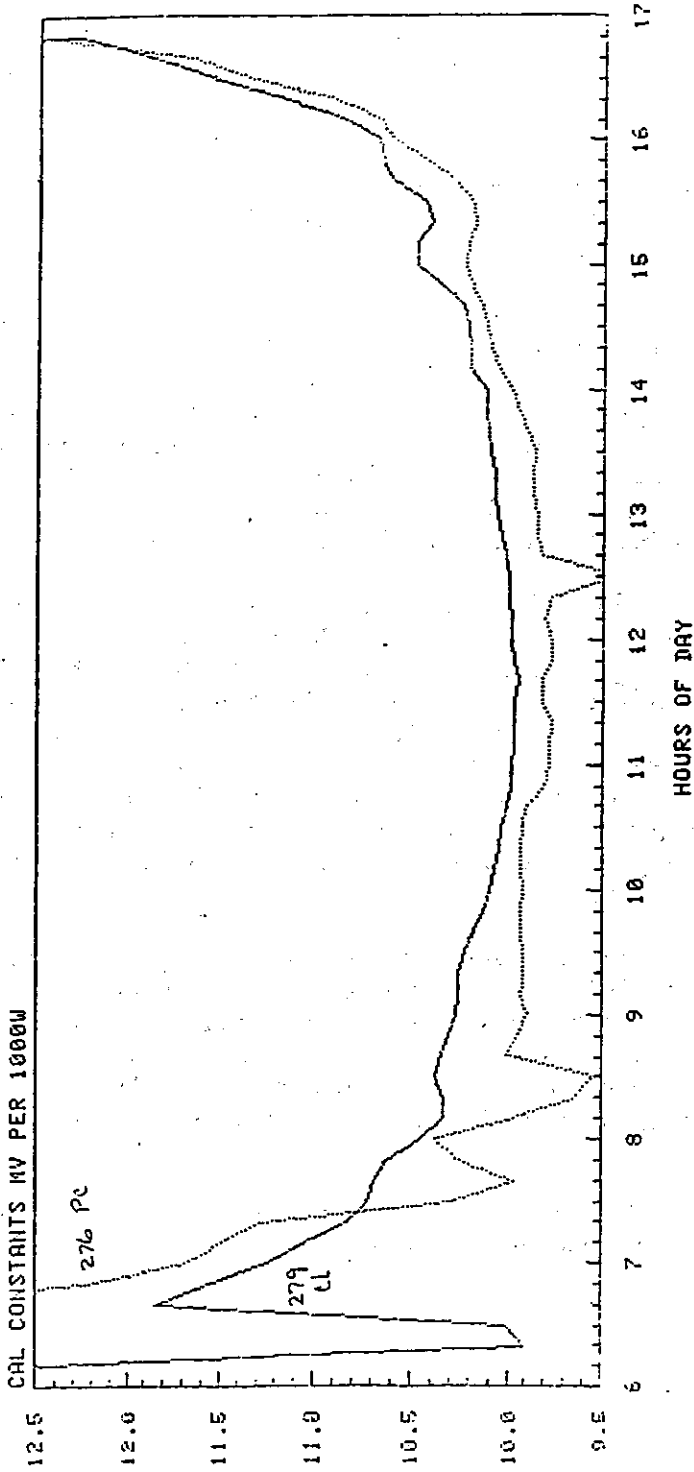

FIGURE N-1. EXAMPLE OF THE DERIVED CALIBRATION OF A LI-COR INSTRUMENT AS A FUNCTION OF THE TIME OF DAY FOR TWO DIFFERENT DAYS.

LAMBDA C* AS A FUNCTION OF DOY
DAILY CAL CONSTANTS

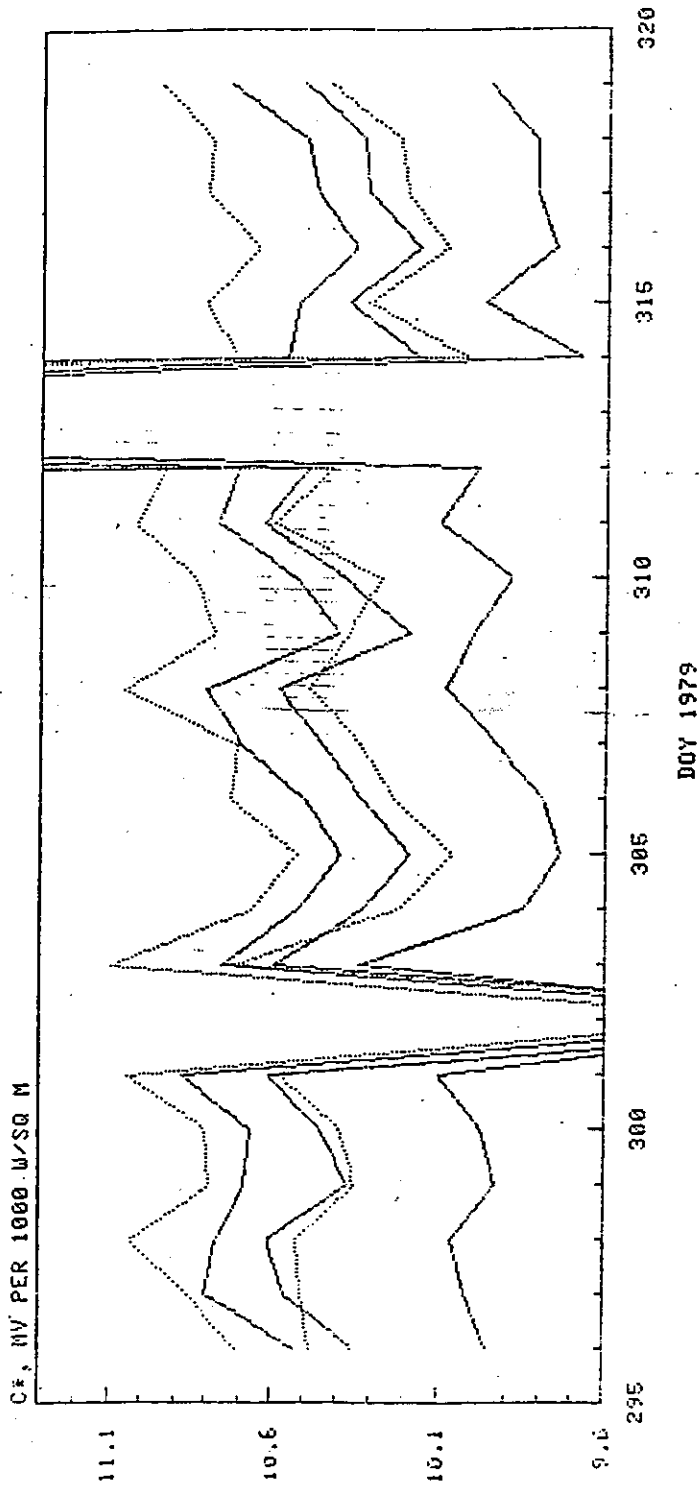

FIGURE N-2. COMPARISON OF DAILY CALIBRATION CONSTANTS FOR FIVE LI-CORS OVER A 24 DAY PERIOD.

LAMBDA C# AS A FUNCTION OF DOY

INSTR. SN 2255 FOR MAY-OCT. 1980

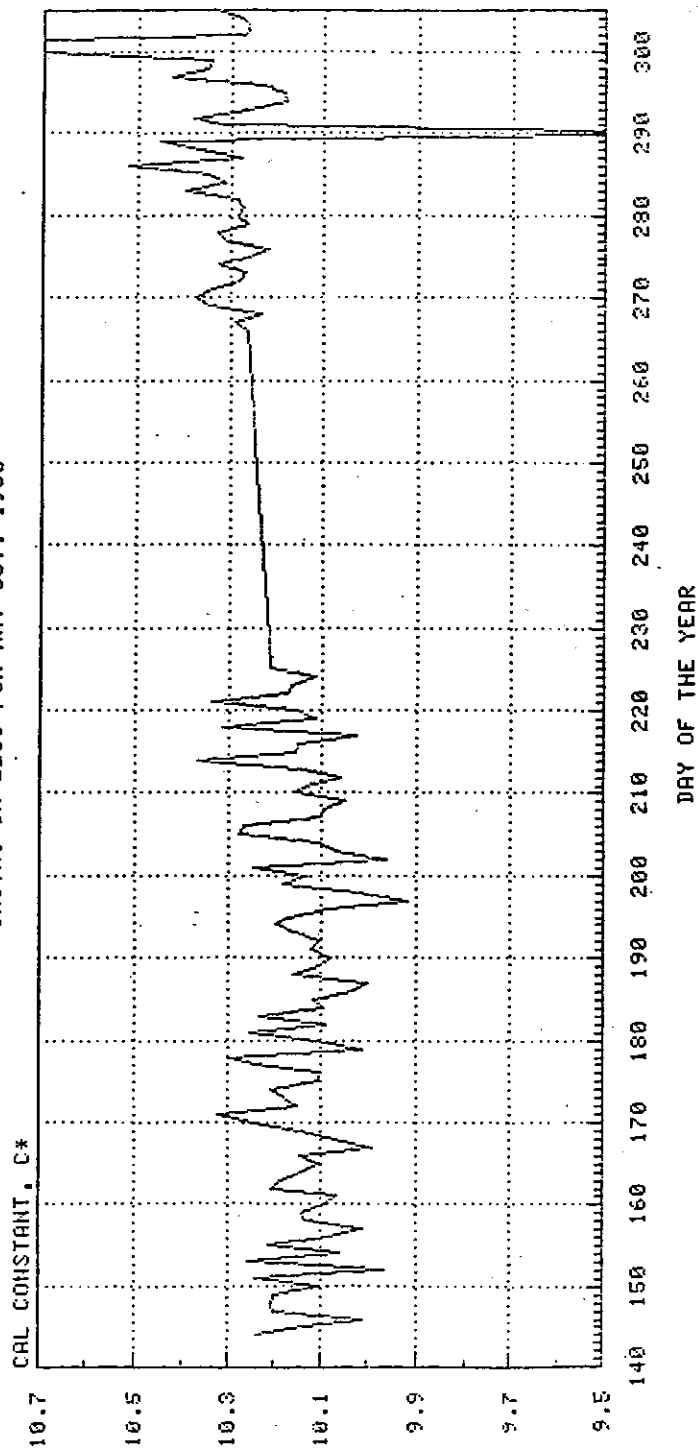

FIGURE N-3. CALIBRATION CONSTANT AS A FUNCTION OF DAY OF THE YEAR.

APPENDIX 0

**Variations in Calibration Factors Computed from
Differences in Cosine Response for Kipp and Zonen
CM-5 Pyranometers**

by

James McGregor
Solar Energy Unit
Department of Mechanical Engineering and Energy Studies
University College
Newport Road
Cardiff, Wales
United Kingdom

**Variations in Calibration Factors Computed from
Differences in Cosine Response for Kipp and
Zonen CM-5 Pyranometers**

by James McGregor
Department of Mechanical Engineering and Energy Studies
University College, Newport Road, Cardiff, Wales, U.K.
March 1981

The angular response of Kipp and Zonen CM-5 pyranometers varies as a function of both azimuth and elevation, but more significantly, for the purposes of calibration, large variations in cosine behavior have been found in a sample of eight (8) Kipp and Zonen CM-5 instruments which were characterized in the laboratory by Dr. James McGregor of the Solar Energy Unit, University College, Cardiff, UK.

These inter-instrumental variations in angular behavior are in the mean attributable to variations in the quality of the detector surfaces.

The laboratory study utilized the spatial goniometer designed and built specifically for the purpose of pyranometer characterization by the National Institute of Agricultural Engineering in Silsoe, Bedfordshire, UK. The response of the eight Kipp CM-5 instruments was measured at 12 equally spaced intervals of azimuth angles for each of 12 different elevations. The implications to calibration due to the variations in angular behavior has been examined using the models of the standard overcast sky described by:

$$N(\theta) = \frac{N(0) (1 + b \cos (\theta))}{(1 + b)}$$

where,

$N(\theta)$ is the irradiance per unit solid angle at zenith angle θ ,

$N(0)$ is the irradiance per unit solid angle at normal incidence, and

b is the coefficient of proportionality.

For the isotropic case, b assumes the value of 0. If we now integrate the above expression and weight the sky according to the angular response of the Kipp CM-5 instrument, the effect of the angular response of the instrument can be calculated as a function of b . This has been done for all eight instruments used in the experiment. Results reveal that scatter as great as 6% can exist for various values of b , in particular the isotropic case where $b = 0$.

Simply on the basis of cosine error, we could, therefore, expect to find differences on the order of $\pm 3\%$ between indoor integrating sphere calibration and indoor normal incidence calibration for the same two CM-5 instruments (of the same model). This would usually imply the comparisons of the standard instrument and the test instrument under calibration.

APPENDIX P

Working Document for Pyranometer Discussions

Submitted by

W. B. Gillett
Solar Energy Unit
Department of Mechanical Engineering and Energy Studies
University College
Newport Road
Cardiff, Wales
United Kingdom

March 1981.

Kipp, Eppley and Schenk PyranometersWhat do we know? What do we need to find out?By W. B. Gillett, Solar Energy Unit, University College, Cardiff CF2 1TA, U.K.INTRODUCTION

Work on pyranometers has been going on for more than fifty years, and the findings are scattered within the scientific literature over this period. Many of the studies have given conflicting results, but in most cases the conflict arises with operating characteristics which are now known to vary from one instrument to another, and the sample sizes studied were small.

Interest in pyranometers has recently increased because they are being used, both for monitoring the performance of solar energy systems and for measuring the efficiency of solar collectors. These new applications are more demanding with respect to accuracy than for general meteorological recording. Unfortunately they also involve a whole new body of scientists and engineers who are unfamiliar with the operating characteristics of pyranometers and their limitations.

Both the European Commission and the International Energy Agency are now involved in pyranometer calibration comparisons. The history of such comparisons is not good, and their results have been very difficult to interpret. In this short note an attempt is made to identify what it is that needs further study, and how it might be done.

CALIBRATIONS

The first stage of a calibration is usually a comparison with a pyrheliometer. The value obtained may be influenced by the following parameters:

Parameter	Corrections possible?
Tilt angle	Yes, varies with irradiance
Temperature	Yes
Irradiance (linearity)	Yes
Comparison time (time response)	Yes
Solar azimuth (azimuth response)	Difficult
Solar altitude (cosine response)	Difficult
Irradiation reference scale used for pyrheliometer	Yes
Radiation spectrum (indoor calibrations)	Difficult

In any calibration, all of these variables need to be recorded, and corrections made to the readings according to the characteristics of the pyranometers involved.

Detailed measurements of Tilt response, Temperature response, Linearity and Time response are available for the pyranometers commonly used (see Tables 1-3). Values need to be agreed for each of these before calibrations can be carried out.

Pyranometers have been shown to exhibit a wide range of values for cosine response and azimuth response (see Table 5). Unless each instrument is individually characterised, results scatter caused by these effects cannot be eliminated. Calibration scatter could be reduced by choosing a solar altitude where cosine errors are small, for example a calibration at near-normal incidence.

There should soon be no reason for calibration differences caused by different Radiation Reference Scales. All countries should follow the W.R.R.

Indoor calibrations suffer from many problems including spectral matching, corrections for irradiance distribution and stability of temperature. Each facility should be validated by comparison with outdoor results.

OUTDOOR INTERCOMPARISONS

These exercises have the advantage of giving an overall impression of the scatter which might be expected from one instrument to another, and hence of the potential accuracy available from an arbitrarily chosen instrument. All the variables discussed above can be seen also to affect intercomparison results, but in addition there are problems of instrument levelling and data sampling which are increased when many instruments are being studied simultaneously.

Intercomparisons may be cheaper than full instrument characterisation and calibration. They also have the advantage that equipment which could be used for comparisons is available within most Met. Services, and hence they provide an opportunity for active participation in international programmes.

In scientific terms an intercomparison is an example of a poorly designed experiment, because far too many parameters are being varied simultaneously. As might be expected in such a situation, those intercomparisons which have taken place to date have served more to confuse than to educate (Appendix 1). More data on cosine and azimuth response variations might be gathered as a result of further intercomparisons, provided that appropriate corrections are made for the other well known pyranometer characteristics. However, the usefulness of more cosine and azimuth response data is questionable, since these parameters have already been shown to vary widely from one instrument to another (McGregor 1980).

If more data on instrument characteristics are required, it would seem more appropriate to obtain these separately for each parameter by laboratory methods rather than by global outdoor comparisons where cosine responses are masked by diffuse irradiance variations (see Appendix II).

SHADING DISC CALIBRATIONS

Details of the recommended system geometry need to be written down. A 2-pyranometer method should be recommended since it is less demanding on instrument time constants.

It cannot be right to average results obtained from a range of azimuth and altitude angles. Either results should be restricted to a limited range of these angles or corrections to a reference incidence angle (eg. normal incidence) should be made.

Kipp & Zonen (depends on irradiance, tilt angle and azimuth angle of tilt axis)

Source	Tilt 45°		Tilt 90°		Comments
	1400 W/m ² %	500 W/m ² %	1400 W/m ² %	500 W/m ² %	
Manufacturers					
IEA Handbook		(-0.5)		(-0.5)	no comment
Norris		+2		+10	from Latimer & Flowers
Dehne 1978	-3	-1	-4	-2	appears to be wrong
Dehne 1978	-1.5	-0.5	-2	-1	axis E-W
Latimer 1970		(-0.1)		(-1)	axis N-S
Sherrig 1977		-0.9	-3.5	-1.8	? azimuth
Andersson 1981		(-1.5)		(-1.5)	CM2 & CM5 axes N-S & E-W
Flowers 1981		-1 to -2			
Flowers 1980		-0.5			? azimuth
Davos 1979		-1 to -2			outdoors by shading
CEC 1980			§-4		av. conclusion

Eppley (PSP) (depends on irradiance, tilt angle)

Source	Tilt 45°		Tilt 90°		Comments
	±0.8	±0.5	±0.8	±0.5	
Manufacturers					
IEA Handbook	(±0.8)	(±0.5)	(±0.8)	(±0.5)	no comment
Dehne 1978	(±0.5)	(±0.5)	(±0.5)	(±0.5)	Latimer & Flowers
Flowers 1980	+0.5	+0.5	+0.5	+0.5	at 450 W/m ²
Sherrig 1977	-0.6	-0.6	-1.5	-1.5	at 470 W/m ²
Goldberg 1980	-0.25	-0.25	+0.75	+0.75	at 1000 W/m ²
Andersson 1980	(negligible)	(negligible)	(negligible)	(negligible)	
CEC 1980			§1.5%		av. conclusion

Schenk (depends on irradiance, tilt angle)

Source	Tilt 45°		Tilt 90°		Comments
	±0.4	±0.5 to -1	±0.9	±1.2	
Manufacturers					
IEA Handbook	(-0.4)	(-0.5 to -1)	(-0.9)	(-1.2)	no comment
Flowers 1980	(-0.4)	(-0.5 to -1)	(-0.9)	(-1.2)	Kahl Star
Mohr 1979	(-0.5 to -1)	(-0.5 to -1)	(-0.9)	(-1.2)	
Andersson 1981	(-2.5)	(-2.5)	(-3)	(-3)	

() indicates irradiance not known

Since the behaviour of pyranometers at different tilt angles to the horizontal is now quite well understood, it may be possible to utilise normal incidence outdoor calibrations by the shading disc method, and in this way avoid the problem of cosine response during calibration.

INDOOR CALIBRATIONS

The accuracy of indoor calibrations depends on the accuracy of the outdoor calibration of the reference pyranometer. However, when like instruments are compared or "calibrated" indoors, there are usually big advantages in time saving and repeatability.

Spacial integrations of cosine responses over the full hemisphere will indicate the likely errors which might result from instrument cosine response errors in a perfectly isotropic chamber. These integrals may need to be weighted for imperfect calibration chambers. Effects such as poor spectral matching and additional thermal radiation in calibration chambers may appear significant in absolute terms, but are unlikely to be important when nominally identical pyranometers are being compared.

CONCLUSIONS AND RECOMMENDATIONS

1. International agreement should be sought regarding appropriate methods of accommodating variations in the following pyranometer characteristics for calibration purposes:

- Tilt angle
- Temperature response
- Irradiance intensity
- Time response

Further experimental work should be carried out (if necessary) to determine average instrument characteristics which can be used in the calibration of Kipp, Eppley and Schenk pyranometers.

2. Reference values of tilt, temperature, irradiance and time response for use in calibrations should be agreed and reported with calibration constants. In addition, the assumptions made to correct measurements to these reference conditions should be stated in calibration reports.

3. Consideration should be given to the wider use of calibrations at near-normal incidence, in order to reduce uncertainty caused by poor and unknown cosine and azimuth responses.

4. The usefulness of further outdoor intercomparisons should be seriously questioned in the light of the decisions reached in 1, 2 and 3 above. The results of intercomparisons may vary with the site (latitude, albedo, levelling etc), the weather (% diffuse, global irradiance, etc), the season (solar altitude, sky conditions) as well as with the well known instrument parameters.

TABLE 2 - TEMPERATURE COEFFICIENT (% per °C)
 (Scatter may be due to the difficulty of performing these measurements)

	% per °C	Comments
<u>KIPP (CMS)</u>		
Manufacturers	0.15	
IEA Handbook	-0.2	
UK Met Office	-0.17	
(Note: separate experiments show -0.07, -0.1, -0.15, -0.19, -0.2)		
Latimer 1970	-0.11	(CM2)
Latimer 1962	-0.02 to 0.1	(CM2)
Weaving 1974	-0.12	
Andersson 1981	-0.075	-10°C to 30°C
Flowers 1981	-0.15	
Whiten 1977	-0.1	
<u>EPPLEY (PSP)</u>		
Manufacturers	± 0.03	-20°C to 40°C
IEA Handbook	± 0.03	-20°C to 40°C
Andersson 1981	± 0.03	-10°C to 30°C
CRC 1980	not detected	-10°C to 40°C
<u>SCHENK (Star)</u>		
IEA Handbook	-0.04	-20°C to 40°C
Mohr 1979	-0.1	-10°C to 30°C
Andersson 1981	-0.1	

TABLE 3 - LINEARITY

	Reference Pt (W/m ²)	Sensitivity Variation % per 100 W/m ²	Comments
<u>KIPP (CMS)</u>			
Manufacturers	(±1% over full range)		
IEA Handbook	(±2% over full range)		
Dehne 1978	600	-0.2	
Latimer 1970		negligible	CM2 0 to 850 W/m ²
UK Met. Off. 1979	500	-0.2	
Andersson 1981	500	-0.4	
CRC 1980	(±1.5% over full range)		av. conclusion
<u>EPPLEY (PSP)</u>			
Manufacturers	(±1% over full range)		
IEA Handbook	(±1% over full range)		
Dehne 1978	600	-0.02	
Andersson 1981	500	-0.04	
CRC 1980	(±0.5% over full range)		av. conclusion
<u>SCHENK (Star)</u>			
IEA Handbook	(±1% over full range)		None
Mohr 1979	500	-0.4	
Andersson 1981			

TABLE 5 - COSINE RESPONSE (Instrument levelling is a problem in evaluating this)

KIPP (CM5) Systematic variations with azimuth and altitude angle.
Large variations from one instrument to another

Source	No of instruments studied	% at 45° altitude	% at 20° altitude	Comments
Manufacturers	7			no comment
IEA Handbook	7		(-7 at 10°)	azimuth unknown
Dehne 1978	1	-2.5	+1	N-S
Latimer 1970	Several	(+0.3)	(+5)	azimuth averaged CM2
Anderson 1981	2	-1 to -4	-3 to -8	N-S 2 instruments
Flowers 1981	1	0 to -3	0 to -5	E-W
McGregor 1980	7	-2		Outdoors
		0 to -4	-1 to -11	N-S
		0 to -1.5	+1 to -2	E-W
McGregor 1980	1	0	0	N-S flat thermopile
		0.75	6.5	E-W

EPPLEY (PSP) Nominally symmetrical in azimuth

Source	No of instruments studied	% at 45° altitude	% at 20° altitude	Comments
Manufacturers	7			
IEA Handbook	7			
Dehne 1978	1	-1 to -1.5	(-5 at 10°)	N-S
Mohr 1979	1	-2	-3 to -3.5	azimuth unknown
Anderson 1981	2	0 to -4	-4	N-S
		0 to -3	-1 to -8	azimuth unknown
			0 to -5	E-W

SCHEMK (Star) Nominally symmetrical in azimuth

Source	No of instruments studied	% at 45° altitude	% at 20° altitude	Comments
IEA Handbook	7			
Mohr 1979	8	0 to -2.5	(-7 at 10°)	N-S
Anderson 1981	2	+0.5 to -1.5	+0.5 to -4	azimuth unknown
	2	+1.5 to -0.5	+1.5 to -4	N-S
			+3 to -3	E-W

TABLE 4 - TIME RESPONSE

Source	1/e	90% of final	Comments
KIPP (CM5)			
Manufacturers			
IEA Handbook			
Dehne 1978	.5s	3s	
	2.2s (short)		
	13s (long)		
Latimer 1970	3s	10s	(CM2)
EPPLEY (PSP)			
Manufacturers	1s		
IEA Handbook	1s		
SCHEMK (Star)			
IEA Handbook	6s		

APPENDIX I

RECENT INTERCOMPARISONS

TABLE 6 - LONG TERM STABILITY

	% change	Comment
<u>KIPP (CMS)</u> Manufacturers IEA Handbook Dehne 1978 Latimer & Wilson 1976	±2 (per year) ±0.5 to ±3 <0.5 (60%) <1.5 (93%) <3.1 (all) ≤1%	none 150 studied av. conclusion
<u>EPPLEY (PSP)</u> IEA Handbook Latimer & Wilson 1976 CEC 1980	±2 (per year) <1 (83%) <2 (all) ≤1%	94 studied av. conclusion
<u>SCIENK (Star)</u> IEA Handbook		none

<u>Date</u>	<u>Place</u>	<u>Organisers</u>	<u>No. of Instruments</u>	<u>Result</u>
1971	NASA, Maryland	Thekkere Collingbourne Drummond	(25)	mean +8% -15% anticipate ±2% possible
1978	UK Met Office	CEC Collector Testers Gillett et al	(14)	+1% -6% reduced by temp. and scale corrections
1980 (Mar)	Davos	IEA Task III	(22)	Kipp -2 to -10% Eppley -2 to -8%
1980	NOAA, DSET, EPPLEY	IEA Task III	(3)	Confusion over Kipp <±0.7% for Eppley big differences from Dav
1980 (Oct)	Davos	With pyrheili- ometer com- parisons	(6 Kipp) (1 PSP)	-2% to -8% -6% to -7%
1981	UK Met Office & French Met Office	CEC		

APPENDIX II

WHAT CAN WE LEARN FROM THE 1980 DAVOS INTERCOMPARISON?

KIPP CM5

If the average of the Kipp calibrations is taken, including the UK CM5 773056 (using its original Kipp calibration), then the results are 6.9% below the Davos reference.

The Kipp calibrations are said to be referenced to 22°C, so at Davos (10°C) the irradiance measurements should have been reduced by 1.8% giving an initial discrepancy of -6.7%.

The Kipp calibrations are referenced to IPS 1956, so a correction to WRR increases their reading by 2.2% giving a new discrepancy of -6.5%.

Recent work at Davos has indicated a cosine response error in the WRC reference of +2.5%. This gives a new discrepancy of -4%.

Cosine response measurements made by McGregor on 7 CM5 instruments (not those of the Davos March comparison) suggest an average cosine error of -2.1% at 30° solar altitude. This might be used to reduce the unexplained discrepancy to -1.9%.

A letter from Kipp & Zonen in 1979 reported that their calibration reference (CM2) is calibrated at Davos. There is a possibility of confusion between the temperature at which this primary calibration was performed and the temperature in the Kipp factory. 10°C here could explain the discrepancy.

The UK CM2 has a positive cosine response. If the Kipp reference CM2 has a similar positive cosine response and were calibrated by the shading disc method before being used for normal incidence "calibrations" at Delft, then new instruments could receive calibration constants which would underestimate the irradiance. An error of 1% to 2% would be possible here.

EPPLEY PSP

The Eppley calibrations were on average 6.1% below the WRC reference.

Until 1980 the Eppley instruments were calibrated to IPS 1956 so a correction of +2.2% to WRR would reduce the discrepancy to -3.9%.

A cosine error in the Davos reference pyranometer of +2.5% would further reduce the discrepancy to -1.4%.

Recent work at Eppley confirms the possibility of cosine errors in PSP instruments up to -2.5% at low incidence angles. Hence the Davos and Eppley results agree well.

a) Postscript: Eppley instruments were calibrated to IPS 1956 until April, 1977 according to John Hickey from the Eppley Laboratory, 16 March 1981.

APPENDIX II continued

BRITISH KIPPS

The agreement in March 1980 between the UK Kipp CM2, the UK Kipp CM5 and the WRC reference is difficult to explain, since both UK instruments were calibrated outdoors in the UK using the shading technique at altitudes around 60°, and were referenced to 10°C.

Subsequent comparisons in October 1980 of the UK CM2 showed results which were 3% lower than the WRC reference. These latter results would confirm the suggested +2.5% cosine error in the WRC reference. The October irradiance levels were low, but the solar altitude angles were similar to March.

WRC KIPP 785017

This instrument has the confusing property of agreeing with the UK CM2 in both the March and the October comparisons to within less than 1% while using the same calibration factor. This is difficult to explain.

CONCLUSIONS

- (1) Comparisons are confusing. It is particularly difficult to compare pyranometers for which the cosine response is not known.
- (2) Reference temperatures, radiation scales and the calibration techniques used must be recorded in detail before comparisons can be interpreted.
- (3) More knowledge of the WRC instrument characteristics is required. In particular the cosine response should be established as a function of azimuth. Linearity should also be confirmed.
- (4) The calibration history of the manufacturers' reference instruments should be confirmed. In particular the reference temperature of the Kipp sub-standard should be checked.

REFERENCES

- Bener, P. "The Operation of the Moll Gorcynski Solarimeter" (UK Met. Office Translation 1288). Arch.Met.Geoph.Bioklim. Wien B.2. 1950. pp.188-248.
- Latimer, J.R. "Laboratory and field studies of the properties of radiation instruments". Met. Branch, Dept of Transport, Canada CIR-3672, TEC-414. 8 June 1982.
- Dehne, K. "Wichtige Spezifikationen von pyranometern für Solarenergie-Belange". Vol.2, pp.163-178, Proc.2nd Int. Solar Forum, Hamburg, July 1978.
- Coulson, K.L. "Solar and Terrestrial Radiation". Academic Press 1975.
- Latimer, J.R. "Investigation of solar radiation instruments at the National Atmospheric Radiation Centre of the Canadian Met. Service". Paper 3/1, ISES Conf., 1970, Melbourne, Australia.
- Norris, D.J. "Calibration of pyranometers in inclined and inverted positions. Solar Energy Vol.16, pp.53-59, 1974.
- Latimer, J.R., Wilson, J.H. "On the Calibration Stability of Kipp and Zonen Pyranometers". Private Communication. July 1976.
- Latimer, J.R., Wilson, J.H. "On the Calibration Stability of Eppley Precision Spectral Pyranometers (Model 2). Private Communication. July 1976.
- Latimer, J.R. "Calibration Program of the Canadian Meteorological Service". Solar Energy Vol.10, No.4, pp.187-190, 1968.
- Drummond, A.J., Greer, H.W. "An Integrating Hemisphere (Artificial Sky) for the Calibration of Meteorological Pyranometers". Solar Energy Vol.10, No.4, pp.190-194, 1968.
- CEC "Proceedings of a workshop on the accuracy of pyranometers for radiation measurements" 18/19 Sept. 1980. CEC Internal Document.
- Mohr, A.J., Dahlberg, D.A., & Dinbourn, I. "Experiences with tests and calibrations of pyranometers for a mesoscale solar-irradiance network". Solar Energy Vol.22, pp.197-203, 1979.
- Hickey, J. "Report of tests of three pyranometers which were included in the March 1980 IEA intercomparison at Davos". IEA paper Jan. 1981.
- Talarak, H.D. "Results of a pyranometer comparison", Davos March 1980. IEA Task III Report.
- Andersson, H.E.B. "Kalibrering och provning av pyranometrär Statens Provningsanstalt SP-RAPP 1981:1.
- Gillett, W.B. "The Kipp Solarimeter, a review of its operation and calibration", May 1979. To be published by CEC (now as CEC working paper).

APPENDIX Q

Pyranometer Calibrations

Forwarded by

W. B. Gillett
Solar Energy Unit
Department of Mechanical Engineering and Energy Studies
University College
Newport Road
Cardiff, Wales
United Kingdom.

Summary of Recommendations by W.B. Gillett

(Please refer to Working Document, March 1981 for details)

1. Average characteristics for Kipp, Eppley and Schenk pyranometers should be agreed, either from the existing literature or from further experiments for the following parameters:

Tilt response, Temperature response, Irradiance intensity, Response time.

2. Reference values for each of these parameters should be agreed for calibration purposes. The reference values and characteristics used to correct measurements to reference conditions should be published with all instrument calibrations.
3. A detailed survey of cosine response curves should be used to determine the suitable range of incidence angles at which calibrations can be meaningfully made with instruments for which the cosine response has not been measured. This may result in a recommendation for near-normal incidence ($\pm 20^\circ$) calibrations. These could be performed by tilting the pyranometers because the tilt response is quite consistent from one instrument to another.
4. A simple guide should be written for the shading disc calibration method including recommendations 1,2 and 3 above. This should be a two pyranometer method.
5. The errors involved in indoor calibration methods should be identified and quantified, and a simple guide should be written.
6. The usefulness of further global intercomparisons should be seriously questioned since they permit too many variables to change simultaneously and are difficult to interpret.

Solar elevation in degrees	Vertical component of the sun (S_V) in Wm^{-2}	Diffuse radiation (S_D) in Wm^{-2}	Pyranometer reading (S_p) in Wm^{-2} and ratio $S_p/(S_V + S_D)$ Davos-Standard K+Z Carpentras	Ratio K+Z/Davos
29.0	462.6	42.1	517.0 1.024	0.971
30.0	478.3	41.2	533.9 1.028	0.970
15.2	208.3	29.9	249.8 1.049	0.918

Table 1: Comparison of different calibration techniques. For the calculation of the pyranometer readings, the calibration factors determined by WRC and Carpentras respectively are used, for the K+Z corrected for temperature with -0.17% per degree.

REFERENCES

- Boner, P. "The Operation of the Moll Gorcynski Solarimeter" (UK Met. Office Translation 1288). Arch.Met.Geoph.Bioklim. Vion B.2. 1950. pp.168-249.
- Latimer, J.R. "Laboratory and field studies of the properties of radiation instruments". Met. Branch, Dept of Transport, Canada CIR - 3672, TEC-414. 8 June 1982.
- Dahne, K. "Wichtige Spezifikationen von pyranometern für Solarenergie-Belange". Vol.2, pp.163-178, Proc.2nd Int. Solar Forum, Hamburg, July 1978.
- Coulaon, K.L. "Solar and Terrestrial Radiation". Academic Press 1975.
- Latimer, J.R. "Investigation of solar radiation instruments at the National Atmospheric Radiation Centre of the Canadian Met. Service". Paper 3/1, ISES Conf., 1970, Melbourne, Australia.
- Norris, D.J. "Calibration of pyranometers in inclined and inverted positions. Solar Energy Vol.16, pp.53-55, 1974.
- Latimer, J.R., Wilson, J.H. "On the Calibration Stability of Kipp and Zonen Pyranometers". Private Communication. July 1976.
- Latimer, J.R., Wilson, J.H. "On the Calibration Stability of Eppley Precision Spectral Pyranometers (Model 2). Private Communication. July 1978.
- Latimer, J.R. "Calibration Program of the Canadian Meteorological Service". Solar Energy Vol.10, No.4, pp.187-190, 1966.
- Drummond, A.J., Greer, H.W. "An Integrating Hemisphere (Artificial Sky) for the Calibration of Meteorological Pyranometers". Solar Energy Vol.10, No.4, pp.190-194, 1966.
- CEC "Proceedings of a workshop on the accuracy of pyranometers for radiation measurements" 18/19 Sept. 1980. CEC Internal Document.
- Mohr, A.J., Dahiberg, D.A., & Dimhorn, I. "Experiences with tests and calibrations of pyranometers for a mesoscale solar-irradiance network". Solar Energy Vol.22, pp.197-203, 1979.
- Hickey, J. "Report of tests of three pyranometers which were included in the March 1980 IEA intercomparison at Davos". IEA paper Jan. 1981.
- Talarek, H.D. "Results of a pyranometer comparison", Davos March 1980. IEA Task III Report.
- Andersson, E.E.B. "Kalibrering och provning av pyranometrar Statens Provningsanstalt SP-RAPP 1981:1.
- Gillett, W.B. "The Kipp Solarimeter, a review of its operation and calibration", May 1979. To be published by CEC (now as CEC working paper).

APPENDIX R

Pyranometer Calibration and Characterization Procedures

Assembled by

C. Wells
Solar Energy Research Institute
1617 Cole Boulevard
Golden, Colorado 80401
U.S.A.

from work of conference attendees and
material of

R. Bahm
Solar Radiation Measurement
Solar Data Analysis
2513 Kimberley Court NW
Albuquerque, New Mexico 87120
U.S.A.

K. Dehne
Deutscher Wetterdienst
Framredder 95
D-2000 Hamburg 65
Federal Republic of Germany

PYRANOMETER CALIBRATION AND CHARACTERIZATION PROCEDURES

This appendix contains some descriptions of procedures, techniques and apparatus employed in the various laboratories around the world. This listing is not entirely complete for all of the procedures mentioned in the following Laboratory Procedure Matrix Table, nor does it present all of the subtle variations developed and employed at the various labs. Formally documented legal or consent standards or "cook-book" procedures may not exist for all of these techniques, nor are they employed by all laboratories.

R.1.0 LABORATORY PRACTICE AROUND THE WORLD

The following Laboratory Procedure Matrix Table shows both the similarities and differences in the methodology employed in various laboratories. It is believed to be accurate in all details, but this cannot be assured in that a representative was not available from every laboratory to verify all of the information. An "X" in the table signifies that the parameter is rarely measured or that the capability to make the measurement does not exist at that particular laboratory. "INA" is an abbreviation for "Information Not Available", signifying that at the time of the development of the table, it was not known which methods or procedures were employed at the particular laboratory, or it was not known whether that laboratory possessed the capability to make the measurement.

It is specifically to be noted that those laboratories participating in the Ad Hoc Round Robin following the March 1980 Pyranometer Comparison conducted at Davos, Switzerland, do not utilize the same techniques nor possess the same capability.

The choice of which laboratories to include in the table was based on:

- the laboratory's participation in the March 1980 Davos comparison or the following round robins;
- being a manufacturer of pyranometers; and/or
- the availability of information concerning at least some of the techniques and capabilities employed at the laboratory.

R.2.0 REPRESENTATIVE CALIBRATION AND CHARACTERIZATION PROCEDURES

The material printed here has been written or furnished by members of the technical staff of the various laboratories or drawn extensively from the publication by Raymond J. Bahm and John C. Nakos, "The Calibration of Solar Radiation Measuring Instruments" [5].

The procedures are given in the same order as listed in the Laboratory Procedure Matrix Table, and as discussed in Sec. 2.0 Recommendations, as a possible sequence in which to be performed.

Representative procedures are included for the following parameters.

Table R-1. Laboratory Procedure Matrix Table

Laboratory Parameters	WRC Inverse	NOMA	ACS Canada	INM Hamburg	Czech/UK Meteorological office	Austrian Meteorological Service/School	Utah State University	Kipp & Zonen	Ecology Laboratory	FIN	NIST	Sveinoh International Testing Lab	SEKI
	1/a	1/a	1/a	1/a x rot from curve	1/a	1/a	1/a	1/a	1/a	1/a	1/a	1/a	1/a
1. Response with time	Outdoor shading disc (calibrated by diffuser and direct measurements)	Outdoor shading disc and direct comparison with reference outdoors lab sphere transfer	Outdoor shading disc and direct comparison with reference outdoors lab sphere transfer	Indoor normal incidence and outdoor shading	Indoor normal incidence and outdoor shading	Outdoor shading disc	Outdoor shading disc	Indians normal incidence	Indoor sphere and outdoor shading	IMA	Outdoor shading pyrheliometer	Outdoor shading disc	Shading disc outdoors and reference pyrheliometer outdoors
2. Sensitivity	Temperature chamber	Temperature chamber	Temperature chamber	Temperature chamber	Temperature chamber	Temperature chamber	Temperature chamber	Temperature chamber	Temperature chamber	IMA	Outdoor shading disc	Outdoor shading disc	Shading disc outdoors and reference pyrheliometer outdoors
3. Temperature coefficient of responsivity	Temperature chamber	Temperature chamber	Temperature chamber	Temperature chamber	Temperature chamber	Temperature chamber	Temperature chamber	Temperature chamber	Temperature chamber	IMA	Temperature chamber	Temperature chamber	Temperature chamber
4. Thermal transient response	Temperature chamber	Temperature chamber	Temperature chamber	Water bath (not routine)	IMA	IMA	IMA	Temperature chamber	Thermally shocked by heated fluid	IMA	Temperature chamber	Temperature chamber	Temperature chamber
5. Nonlinearity	Adding technique	Adding technique	Adding technique	Rotating meter	Rotating sector	Rotating sector	Rotating sector (outdoors)	Rotating sector	Against self-calibrating pyrheliometer	Rotating sector and square law	Against self-calibrating pyrheliometer	Adding technique	Adding technique
6. Tilt effect	Outdoor shading disc	Outdoor tilt table	Turning arm	Rotating chamber	Special response goniometer	Turning arm	Turning arm and outdoor shading disc	Horizontal beam rotating disc	Outdoor shading disc	IMA	Outdoor normal incidence shading	Turning arm	Outdoor tilt table
7. Angular dependence	Outdoor shading disc	Zenith dependence outdoors by shading meter about vertical axis	Turning arm	Horizontal beam	Special response goniometer	Turning loop	Turning loop	Horizontal beam goniometer	Outdoor shading disc	IMA	Outdoor shading on tilt table	Zenith dependence with horizontal beam and azimuth turntable	Zenith dependence by outdoor shading
7a. Linearity	By the spirit level	Radionometrically	Radionometrically	Radionometrically	Radionometrically	Radionometrically	Radionometrically	Radionometrically	Radionometrically	IMA	By the spirit level	Radionometrically	By the spirit level
8. Spectral response	Calculations from published data	Calculations from published data	Calculations from published data	Calculations from published data	IMA	Schott glass filters outdoors	Monochromator for white and blue (not routine)	Calculations from published data	Spectrophotometer calibration of glass	IMA	Calculations from published data	Spectrophotometer calibration of glass	From long term records
9. Long term stability	From long term records	From long term records	From long term records	From long term records	From long term records	From long term records	From long term records	From long term records	From long term records	IMA	From long term records	From long term records	From long term records

R.2.1 Time Response

R.2.2 Responsivity

R.2.2.1 Reference Pyranometer and Pyrheliometer Methods

R.2.2.2 Shading Disc Method (Sun and Shade Method)

R.2.2.3 Collimation Tube Method

R.2.3 Temperature Coefficient of Responsivity and Dynamic Response

R.2.4 Thermal Transient Response Behavior

R.2.5 Nonlinearity

R.2.6 Tilt Effect

R.2.7 Angular Dependence

R.2.7.1 Azimuthal Response

R.2.7.2 Cosine Response

R.2.7.3 Levelling

R.2.8 Spectral Response

R.2.9 Stability

R.2.1 TIME RESPONSE

The objectives of determining the time response of a pyranometer are as follows:

1. Determination of the time for reaching a "final value";
2. Knowledge of zeropoint fluctuations (noise phenomena); and
3. Control of sensor stability.

The physical reason for the time response is the thermo-dynamical behavior of the sensor which can be simulated by a circuit of thermal resistors and capacitors (see Fig. 1) The time response can be described by a superposition of exponential functions with different time constants representing the decrease to $1/e$. The shortest time constant corresponds to the heat exchange from the hot to the cold junctions of the thermopile. Mainly responsible for the long-time behavior is the heat exchange between the glass domes and the body of the receiver. (On the theoretical estimation of time constants see: Courvoisier and Weirzejewski or Kuhn)

The test method consists of a radiation on-off procedure using lamp and screen, for the main time constant τ_1 . Since in general, τ_1 is between 1s and

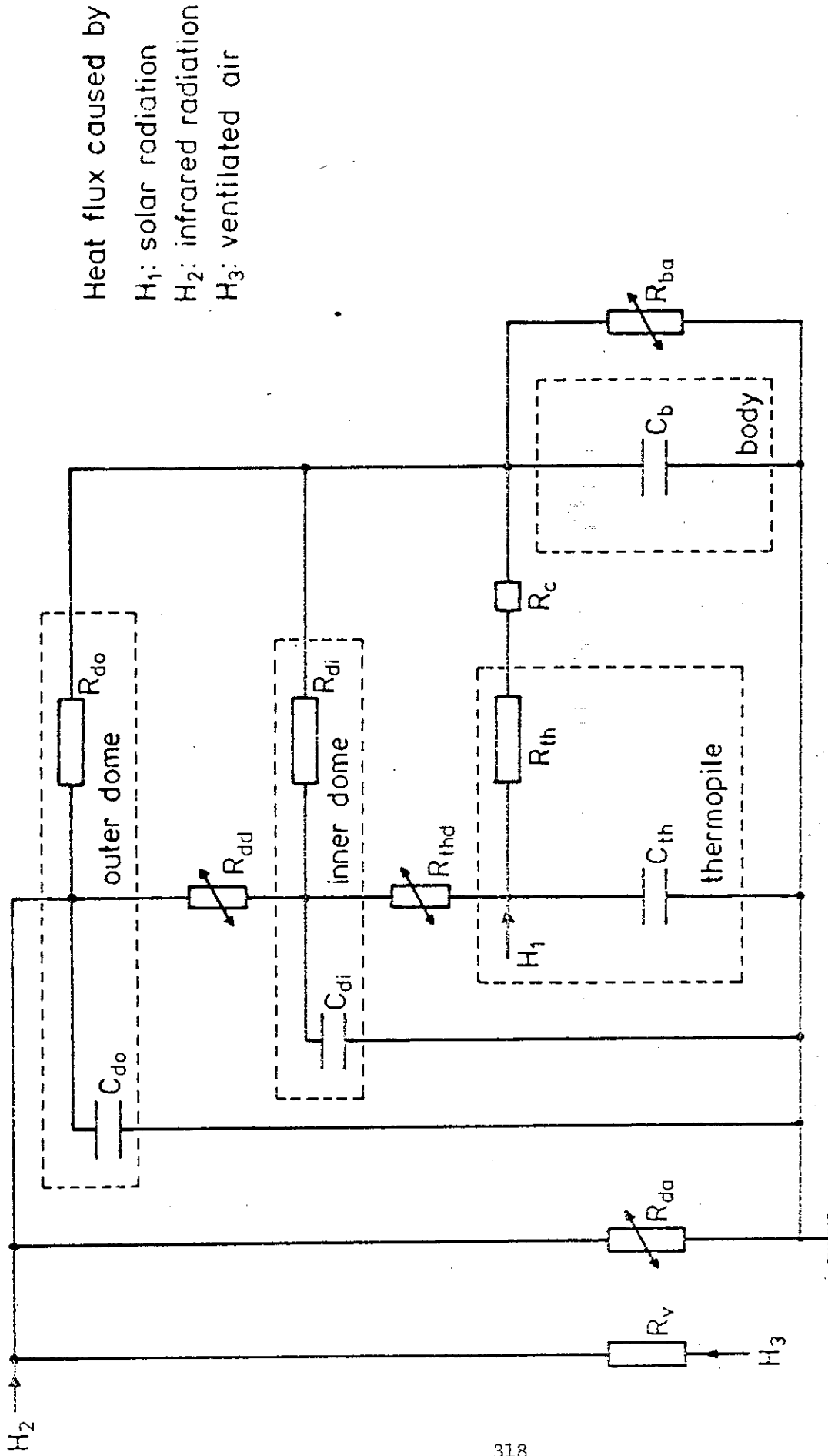

Fig. 1: Simulation circuit of a pyranometer with a black thermopile and two glass domes

6s and since high accuracy is not required, recording the mV-signals by a strip chart recorder with a 1s deflection for full scale will be sufficient.

A measure for the long time response is the time for reaching 90% to 95% of the final value. The determination of the time to reach even higher percentages would increase the requirements to the test technique dramatically. The radiation on-off procedure does not require a highly stabilized lamp but good μ V-recorders (DVM). Furthermore, the environmental conditions must be specified because temperature, wind speed, and IR affect the result.

If nonlinear heat conduction processes are expected, this test procedure should be repeated using both high and low levels of irradiance.

The definition of the measured value is related to the time for reaching the "final value", t_f , as defined as the minimum time, dependent on the required data accuracy and the measured long time response. The rule that after 5 times τ , the final value is reached within 1%, is only applicable to ideal receivers. The realistic "final time" should be determined for each instrument type or even for each individual instrument separately if a high level of accuracy is required.

For laboratory tests, there are good reasons to define the measuring value M as the difference between the S gained with incident radiation and the zero signal Z (zero point) gained without radiation: $M = S(t_f) - Z(t_f)$; Z should be the mean of zeroing before and after irradiation. Then, the offset produced by heat exchange between the pyranometer and the environment (ventilated air, infrared, stray light, etc.) as well as the possible offset of the recording unit will be eliminated. This definition is particularly recommended for tests with low level radiation. Furthermore, the advantage of time-saving should be emphasized because waiting for a good setting of the steady state is not necessary anymore.

On the other hand, in the routine of outdoor measurements the zeroing procedure is not very practical and is used only in special cases. Instead, the statistical evaluation of the data eliminates a large amount of offset. However, in the case of relative stable offset such as produced by ventilation of the glass domes, reduction of this offset by subtracting the mean value gained during the night is recommended.

R.2.2 SENSITIVITY [Calibration Factor]

The determination of the sensitivity delivers the calibration factor, K, since $R = 1/K$, for instance. The procedures given in this section include both commonly used procedures, and some which have never been tried. The user of these procedures must judge for himself which are appropriate for his instrument and the measurements he wishes to make with that instrument.

R.2.2.1 Determination of the Calibration Factor - Transfer From Another Pyranometer in Sunlight

Two (or more) pyranometers are mounted in a horizontal position, side by side, separated by at least 30 cm and preferably 1 meter, so that each views the same sky dome. The instrument is oriented so that the bubble level is closest to the nearest pole (north pole in northern hemisphere, south pole in the southern hemisphere). Preferably there are no obstructions on the entire horizon. One (or more) of the pyranometers is the standard. The output of each instrument is then connected to a specified load, and the voltages are compared. The ratios of the calibration constants are the same as the ratios of the output voltages. The instruments should be allowed to stabilize in the environment for at least one hour before taking any data.

It is often desirable to integrate or average the outputs over a period of time and to then compute the calibration constants on the basis of these averages. This reduces the errors due to differences in dynamic response, sun angle, and other factors which may average out in a number of readings.

There are at least two different philosophies regarding the type of weather conditions under which this calibration should be made. The first is that the conditions should be such that they are as nearly reproducible as possible. Thus calibrations should be done only on the clearest days, and at the time of the year when the sun is relatively high in the sky. The second philosophy is that the instruments should be calibrated at conditions which are representative of those under which they are to be used. Thus averages of the data are made over much of the day and data are taken for days which include a variety of weather conditions.

Each of these methods has its benefits. The first would be better for determining long term drift of the calibration, and for providing a precise calibration constant. The second might be better for transferring calibration between two instruments which had slightly different spectral response but were to be used to make the same all-weather measures.

R.2.2.2 Determination of the Calibration Factor - Transfer from Another Pyranometer in Laboratory

This method should only be used where the transfer is between instruments of the same manufacturer and model, and which use the same optical surface and coatings. Two procedures are used in different laboratories. In the "direct beam" procedure, the reference pyranometer and the pyranometer to be calibrated are alternately irradiated by a beam of good homogeneity and high stability, usually at normal incidence. In contrast to this is the case of the "integrating sphere" procedure, in which the pyranometers are irradiated by diffuse radiation from the white walls in a large sphere, which are illuminated indirectly by lamps. Such a room is designed so that illumination flux levels at all points where the instruments are located are as equal as possible.

The design and construction of such a room are beyond the scope of this report, but special problems must be considered including cooling the surface of the sphere and maintaining constant air temperatures. These can be

difficult because of the high flux levels required. Flux levels should be close to those experienced on a sunny day out of doors.

In the use of this method, instruments are placed in the sphere, and the illumination is turned on. Conditions are allowed to stabilize, and then the data are collected which determine the calibration constants.

This method is most useful in a manufacturing facility or very cloudy climate, where the number of calibrations is important and schedules cannot be stretched to accommodate the weather unpredictability. The spectral content of the illumination in the sphere is not the same as sunlight. The proper use of this method requires considerable experience.

R.2.2.3 Determination of Calibration Factor - Methods Involving Transfer from a Pyrheliometer

The step is necessary to initially obtain and to maintain a calibrated pyranometer. There are not standards of radiation which are adequate for calibrating pyranometers, because of their wide angle of sensitivity. The best currently available standards are embodied in the so-called "absolute instruments", discussed in the following section of this report. These instruments measure the radiation over only a small solid angle, for instance, 5.7° and thus a special procedure is required to transfer the calibration to a pyranometer.

The transfer of calibration from a pyrheliometer to a pyranometer should always be done in a climate and under sky conditions which have strong beam solar radiation and a minimum of circumsolar radiation. Figure 17 shows two examples of measured circumsolar radiation. Note how the intensity at the Albuquerque site falls by over 3 orders of magnitude within $1/2$ degree of the center of the solar disc. Tracking errors of the pyrheliometer or alignment of the shading disc will have less effect on the calibration during periods of low circumsolar (clear atmosphere) than during periods of increased atmospheric scattering.

There are two basic methods for transferring calibration from a narrow field of view instrument (pyrheliometer) to a wide field of view instrument (pyranometer). These are often called:

- The sun and shade method, and
- the collimation tube method.

Each of these can be done in two ways:

- the pyranometer mounted horizontally,
- the pyranometer tracking and normal to the incoming beam radiation.

The pyranometer senses the radiation coming from an entire hemisphere of the sky dome. We call this the total radiation (I_T). The pyrheliometer senses only the radiation coming from an area immediately adjacent to the solar disc. We call this the beam radiation (I_b). The diffuse radiation (I_d) is commonly defined as all the total radiation except for the beam radiation.

$$I_d = I_T - I_b$$

In the sun and shade method I_d and I_T are measured with the pyranometer being calibrated and I_b is measured with the pyrliometer. While in the collimation tube method only I_b is measured.

R.2.2.3.1 Shading Disc Method (The Sun and Shade Method)

Using the sun and shade method a disc, which obscures a portion of the sky equal to the same solid angle seen by the pyrliometer (such as 5.7° dia.), is used.* The disc is alternately placed between the sun and the pyranometer, and removed. The difference of these two readings represents the direct beam radiation, as measured by the pyrliometer. If the pyranometer is mounted in the horizontal position, the difference must be multiplied by the cosine of the solar zenith distance to obtain the proper value. The sun and shade method is illustrated in Fig. 18.

It is always a good practice when performing calibrations on one pyranometer to have a second pyranometer measuring the total or preferably the diffuse radiation during the experiment, to assure that changes in the levels of radiation do no occur. A continuous record of both this and the pyrliometer output should be kept during the calibration period to assure there is truly clear sky and steady radiation. Experimenters should stay out of the field of view of the instruments while data are being taken. Even small amounts of radiation reflected from skin or clothing can affect the accuracies.

The equations for transferring calibration from a pyrliometer (instrument 1, subscript = 1) to a horizontal pyranometer (instrument 2, subscript = 2) are:

$$K_2' = V_1 K_1 \cos(90 - \alpha) / \Delta V_2$$

where: α = the solar elevation (degrees)

V_1 = output of pyrliometer (mV)

$\Delta V_2 = V_2 - V_{2s}$ (mV)

V_2 = output of pyranometer (not shaded) (mV)

V_{2s} = output of pyranometer shaded (mV)

K_1 = calibration constant of pyrliometer (kW/m²/mV)

K_2 = original calibration constant of pyranometer (kW/m²/mV)

K_2' = new calibration constant of pyranometer (kW/m²/mV)

*To realize a shaded angle of 5.7°, it is common to use a 10 cm diameter disc at a distance of one meter from the pyranometer. The disc is fastened to a long narrow rod on a stand so that it can be put in place and left for a short time.

Note that the sensitivity of pyranometers is often given in the reciprocal units 10^{-6} V/W/m² (just 1/K used here).

As an example of recalibration let us assume:

$$1/K_1 = 6.41 \times 10^{-6} \text{ V/W/m}^2, K_1 = 0.1560 \text{ (kW/m}^2\text{/mV)}$$

$$1/K_2 = 8.93 \times 10^{-6} \text{ V/W/m}^2, K_2 = 0.1120 \text{ (kW/m}^2\text{/mV)}$$

$$V_1 = 6.23 \text{ mV}$$

$$V_2 = 7.01 \text{ mV}$$

$$V_{2s} = 0.55 \text{ mV}, \Delta V_2 = 6.46 \text{ mV}$$

$$\cos(90 - \alpha) = 0.731$$

Then:

$$K'_2 = 6.23 \times 0.1560 \times 0.731 / 6.46 = 0.110 \text{ (kW/m}^2\text{/mV)}$$

$$1/K'_2 = 9.09 \text{ (} 10^{-6} \text{ V/W/m}^2\text{)}$$

The change in calibration factors can be calculated from:

$$\% \text{ change} = \frac{K'_2 - K_2}{K_2} \times 100 = \frac{0.1100 - 0.1120}{0.1120} \times 100 = 1.8\% \text{ change}$$

This same method could be used to calibrate the pyranometer on a tilt. In this case the angle $(90 - \alpha)$ would be the angle between the direction of maximum sensitivity of the pyranometer (which is the zenith when it is mounted horizontally) and the solar beam radiation.

The calibration of the pyranometer on a tilt can be used to estimate the change of calibration of the pyranometer in the tilted plane from that in a horizontal plane. Note, however, that this method may introduce effects due to interaction with the color of the light reflected from the ground, particularly if the ground cover viewed during calibration was different from that viewed during data collection.

This method for calibrating the pyranometer at a tilt would be most useful for an in-situ calibration, such as on a collector test facility where the pyranometer was not moved between calibration and use.

The same basic procedure is used when calibrating a pyranometer where the pyranometer and the pyrhemliometer are both mounted on a tracking platform $\cos(90 - \alpha) = 1$.

The equation is now:

$$K'_2 = V_1 K_1 / \Delta V_2.$$

The second pyranometer used to assure a constant flux should also be mounted on the tracking platform.

There are a number of factors which limit the accuracy of the foregoing calibration procedure. These are ignored in the equations given, and it has been assumed that the errors due to these factors will be sufficiently small for most uses. With careful procedure, high quality pyranometers, and a high quality absolute instrument for the pyranometer on a very clear day, one should expect repeatability of measures on the order of 0.2% and an absolute accuracy of the calibration on the order of 2.0%. The factors which limit the accuracy of these calibrations include:

- Differential color response. The absolute pyrhelimeter normally has no window glazing, but the pyranometer does. This inherently limits the response of the pyranometer at some wavelengths. The pyrhelimeter with no glazing could therefore possibly be affected by the far infrared sky radiation or lack of it at wavelengths as long as 40 μm . Different paints on the absorbing surfaces, or slightly different colors due to aging and exposure of the instruments could cause some different responses.
- True view angle factors. The equations assume that the edge of the disc for shading the pyranometer, and the edges of the window for the pyrhelimeter provide geometrically sharp cutoffs. In reality this is not true. There are effects due to: the width of the detector elements in both the pyranometer and the pyrhelimeter, (see Figs. 8 and 9), the shape of the sensitivity across the detector elements in both (see Fig. 16), effects due to refraction of the dome of the pyranometer, effects due to internal reflection inside the tube of the pyrhelimeter, and effects due to the diffraction of light on both instruments.
- Reflections from shading disc. It is possible that secondary reflections from the back of the shading disc, or the amount of diffuse sky radiation blocked by the disc support is sufficient to introduce error.
- Other possible effects such as cosine error, temperature errors, etc., which are discussed elsewhere have also been ignored in these equations.
- Variation of the solar flux. Performing experiments on only the very clearest days minimizes the chance of variation. However, there are often high thin clouds invisible to the eye which can be detected as variations in pyrhelimeter, or pyranometer output. Alertness to any possible variation in solar flux detected by instruments is important.

R.2.2.3.2 The Collimation Tube Method

This method is used much less often than the foregoing because it requires a special device to obtain appropriate collimation.

One early pyranometer was constructed with a means for attaching a collimation tube designed to be used with the pyranometer. This instrument is seldom used today because of its limited availability and age.

An example of one type of collimation device is shown in Fig. 19. This device can be used to calibrate the pyranometer in either a horizontal position or

normal I_b . A pyrheliometer, not shown in Fig. 19, is still required as in the sun and shade method.

The equations for calibration in the horizontal position are:

$$K'_2 = V_1 K_1 \cos (90 - \alpha) / V_2$$

and in the normal position:

$$K'_2 = V_1 K_1 / V_2.$$

Insufficient experience with this method is available to be able to give specific accuracies which can be expected. It is likely that this method would provide calibrations with the same accuracies as the sun and shade method.

Factors which limit the accuracy of this method include:

- All factors discussed for the sun and shade method except for, reflection from the shading disc,
- Reflections from the collimating tube and secondary internal reflections inside the box. This is probably the most difficult to control. The inside of tubes and boxes are always painted a flat black. Even so reflections can be a problem.

R.2.3 TEMPERATURE COEFFICIENT OF RESPONSIVITY AND DYNAMIC RESPONSE

R.2.3.1 Determination of Dynamic Response

The test was not regularly performed by any group. The following procedure is suggested:

1. Allow the instrument to stabilize outdoors on a clear day for at least one hour.
2. Cover just the dome with a completely opaque well-insulated cover.

Record continuously the instrument output until it has stabilized again, at least 10 minutes. Repeat steps 1 and 2 until the characteristic has been clearly delineated.

3. Allow the instrument to stabilize outdoors for at least one hour with the cover in place.
4. Remove the cover and allow the reading to stabilize. Record the solar flux continuously with a 2nd pyranometer to assure a baseline for the measurement.

Repeat steps 3 and 4 until the characteristic has been clearly delineated. This method provides two characteristic functions one for a positive step in illumination and the other for a negative.

R.2.3.2 Temperature Coefficient

The temperature coefficient describes the relative sensitivity as function of temperature. This is due to the dependence on temperature of thermoelectric effect and eventually of thermoconductivity, over a typical range of -30°C to $+50^{\circ}\text{C}$.

The specific test method consists of temperating the whole pyranometer (using a climatic box or chamber). It is practical to measure the temperature by steps of 10 K because in general the temperature coefficients are $\leq .2\%/\text{K}$. Regarding the relative low variation and the long time required for the total test, the irradiance of the lamp used must be well controlled. It should be proved whether the test using "running temperatures" delivers the same results as the step-wise test of steady state condition.

R.2.4 THERMAL TRANSIENT RESPONSE

The thermal behavior of the pyranometers can be studied also by thermoshocks that means very rapid changes of the temperature of the outer dome and/or of the body of the pyranometer. This method can be used to quantify drift parameters.

R.2.5 NONLINEARITY

The nonlinearity of a pyranometer describes the relative sensitivity of the function of irradiance. This is due to: 1) heat losses being not proportional to the temperature difference (convective losses, radiant emission, etc.); and 2) nonlinearity of thermoelectric effect. Nonlinearity might occur in pyranometers with large overtemperatures at the hot junctions. The test range considered is usually 1000 Wm^{-2} to 100 Wm^{-2} (for special cases: I_0 $0.1 I_0$).

The test method consists of attenuation of beam radiation by definite steps by:

1. distance variation
2. neutral filter (grey glass)
3. rotating sector.

Because of the relatively high inertia of the thermopile, the use of a rotating sector is recommended. Furthermore, this small-sized device does not deliver spectral effects.

R.2.6 TILT EFFECT

The tilt effect describes the relative sensitivity as a function of the inclination angle of the pyranometer. This is due to effects of air convection between thermopile and glass dome and can be expected from "hot" thermopiles, especially at high irradiances. The range considered is a tilt angle = 0° to 180° (different levels of irradiances: I_0 $0.1 I_0$).

Four groups of test methods are used by various laboratories. The two "turning mirror" methods are described by:

1. The pyranometer mounted for tilting on a rotating arm is irradiated by a fixed lamp by way of a 45° tilted mirror in the turning point of the arm (as used by Norris); and
2. The pyranometer is tilted on a horizontal axis through the thermopile surface and receives the irradiation of a fixed lamp by way of a turning array of two mirrors (spatial response goniometer of NIAE as used by McGregor, Cardiff).

For both procedures, the use of turning mirrors requires the control of beam attenuation because the mirror reflectivity changes with the orientation of the mirror in the case of polarized radiation. The goniometer apparatus, as now in use, should be modified to deliver higher values of irradiance as required for tests of tilt effects.

In the "balance arm" method the pyranometer and lamp are mounted opposite to each other on a turnable beam (as used in different modifications by Flowers, Fimpel, Goldberg and Latimer). The variation of radiant flux due to the tilting of the lamp must be controlled and corrected, if necessary.

In the "turning drum" method the pyranometer is flanged to an opening in the jacket of a cylindrical turning drum and receives diffuse radiation reflected from the whitened inner walls of the drum. Since the radiation of a fixed lamp is fed into the drum through its hollow axis, the irradiance on the receiver surface is constant (after fine adjustment controlled by a silicon sensor) at all turn positions of the drum; that is, at all tilt angles of the pyranometer. The cooling of drum and pyranometer dome is accomplished by ventilated air. (Used by the Met. Obs. Hamburg.)

To get high values of irradiance the "turning drum" is small-sized ($r \approx 10$ cm); therefore the pyranometers only look with the receiver head (glass domes) into the drum.

In the "turning box" method the pyranometer is mounted on the bottom of a ventilated box. In zenith position near the ceiling of the box, a lamp is installed. Since the direct beam is screened by a disk the pyranometer is only irradiated by diffuse radiation reflected from the whitened walls. The inclination of the pyranometer is accomplished by tilting the box. (As used by Ichiki + Ikeda.)

R.2.7 ANGULAR DEPENDENCE

R.2.7.1 Azimuthal Response

The purpose of determining the azimuthal response is to determine:

1. The relative variation of sensitivity as function of the azimuth angle of pyranometer position; and
2. The eventual improvement of leveling (spirit level).

The physical reasons for such a response are:

1. Misalignment of thermopile (resp. spirit level) and glass domes;
2. Asymmetry of glass domes;
3. Caustic effect of glass domes; and
4. Unevenness of receiver surface.

The range of angles considered are:

1. Azimuth angle 0° to 360° ; and
2. Angle of incidence: about 60° to 80° .

The method of testing consists of turning the pyranometer which is irradiated by a beam of defined angle of incidence, about an axis perpendicular to the thermopile surface (center). In general, the pyranometer is horizontally positioned and the angle of incidence is adjusted by a turnable mirror reflecting the beam.

The test is relatively simple; however, in the case of non-circular symmetrical thermopiles the beam must deliver homogeneous irradiance on the test area.

The test routine used at the Met. Obs. Hamburg is described by the pyranometers being directly irradiated by the lamp in a vertical position. Before mounting, the pyranometers are accurately leveled by the level screws in the feet. The tilt effect is unimportant because of the low level irradiance (at $\nu = 60^{\circ}$: $\approx 125 \text{ W/m}^{-2}$). Since the signal variations are relatively low, azimuthal steps of 15° or 30° are sufficient, and the signals are sampled every 30s without zeroing in between.

R2.7.2 Cosine Response

The cosine response is the relative sensitivity as a function of angle of incidence (expressed as percentage deviation from the ideal proportionality to the cosine). The physical reasons for such are:

1. Misalignment of thermopile and glass domes;
2. Inaccurate grindings of glass domes;
3. Caustic effect of glass domes;
4. Unevenness of receiver surface; and
5. Specular reflectance of the black paint.

The test range considered is incidence angles of 0° to 85° (at selected azimuth positions). The test methods utilized consist of:

1. Moving lamp (like the sun) around the horizontal pyranometer (as used for instance by Dirmhirm);

2. Moving inclined mirrors reflecting the beam of a fixed lamp around the horizontal pyranometer (As realized by the "Spatial Response Goniometer" of the National Institute of Agricultural Engineering, Silsoe, Bedford, UK, and by an apparatus of the Met. Office, Bracknell, UK);
3. Tilting the horizontal pyranometer which is irradiated by a fixed lamp in the zenith of the thermopile, about a horizontal axis (As used by J. McGregor, University College, Cardiff, UK.); and
4. Turning the vertically positioned pyranometer which is irradiated by a horizontal beam about a vertical axis (As used at Met. Obs. Hamburg. NOTE: The tilt effect can be neglected because the pyranometer is always in the vertical position and the irradiance levels are low.)

The main requirements for this test are the high homogeneity ($\approx 1\%$) and the small symmetrical divergence of the beam used. Furthermore, the precision in angle readings is important. The quality of the different methods depends on the extent which these requirements are met, as well as on several controls, for instance the behavior of the tilted lamp and the tilt effect of the inclined pyranometers. It should be emphasized that the goniometer in (b) irradiates also the screens of the pyranometers by a beam cross section of 25 cm.

R.2.7.3 Leveling

The problem leading to leveling related errors is that the detector surface, the parallel surfaces of the case and the indicators may not be coplanar. The orientation of the detector surface is critical to any calibration, but as a practical matter must be identified with the top or bottom surface of the case. This identification is the subject of an auxiliary experiment.

The test method consists of:

1. Provide a rotary table and level the upper surface;
2. Mount the pyranometer thereon and level the upper surface of the instrument case; and
3. Investigate the detector level by one of these two methods -
 - a. Radiometric. Irradiate the detector with a constant intensity beam at selected off-axis angle. Rotate the system and observe the signal cyclic variation with azimuth by trial; change the case level to minimize the cyclic signal. Perform the test at two off-axis angles, typically 45° and 60° , or 30° , and 60° .
 - b. Optical. Set up a telemicroscope with eyepiece scale to view the edges of the detector at a large off-axis angle. Observe the upper and lower extremes of the edges as the system is rotated. By trial, change the case level to minimize the edge displacement.

4. With detector surface brought perpendicular to the rotation axis, shim the bubble level to center the bubble.
5. For future reference, measure and note the residual error in the case surface. Use a sensitive bubble protractor for this purpose.

R.2.8 SPECTRAL RESPONSE

Spectral response is sometimes done by measuring the characteristics of the individual components (the dome, black paint, etc.) and then by computing the combined response.

R.2.9 STABILITY

The stability of the pyranometer is directly dependent upon the stability of its individual parameters. The stability of these parameters, then, is proven by repeating the measurement of the parameters at appropriate intervals of time (such as every three, six, or twelve months) depending upon the desired stability information. In all of these measurements, stable references must be used.

APPENDIX S

Calibration and Testing of Pyranometers

by

Hans Andersson, Leif Liedquist,
Johan Lindblad, and Lars-Åke Norsten
Statens Provningsanstalt
National Testing Institute
Physical Measurements
Post Office Box 857
S-501 15 Borås
Sweden

TEKNISKT RAPPORT

CALIBRATION AND TESTING OF PYRANOMETERS

Hans E B Andersson

Leif Liedquist

Johan Lindblad

Lars-Åke Norsten

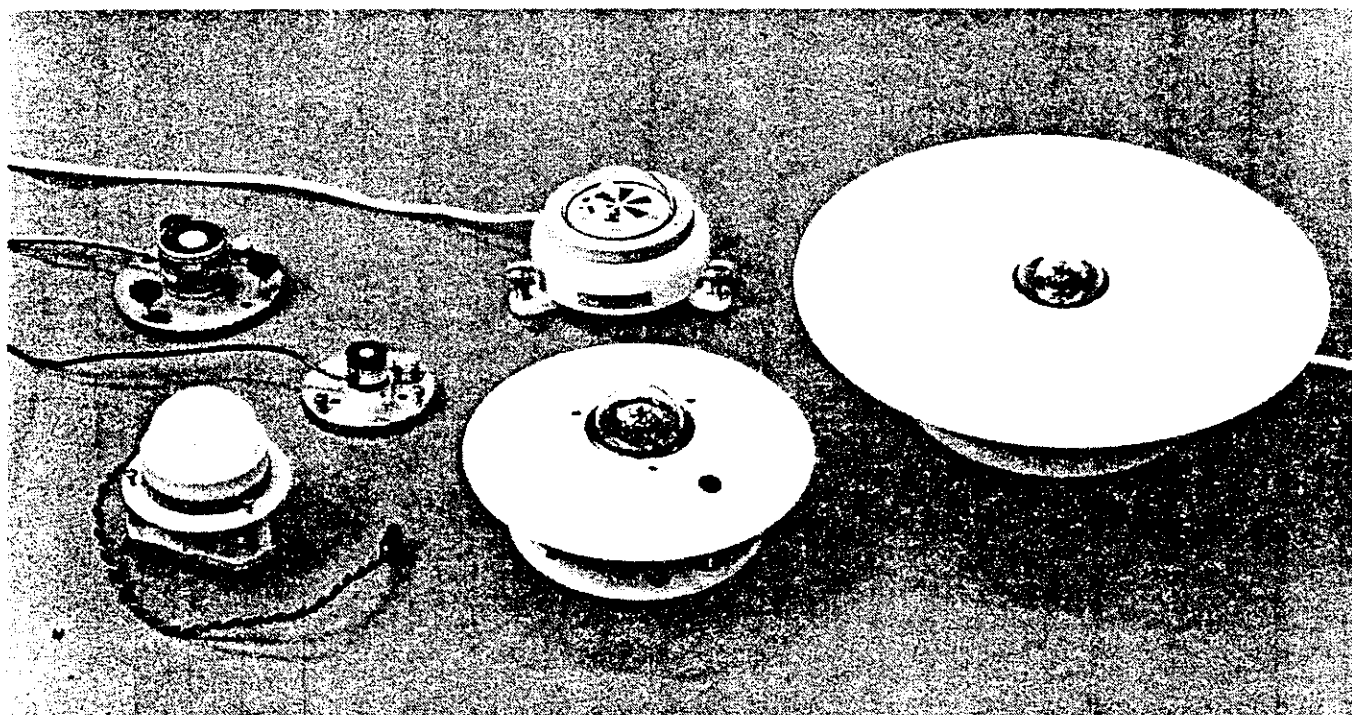

CALIBRATION AND TESTING OF PYRANOMETERS

Hans E. B. Andersson

Leif Liedquist

Johan Lindblad

Lars-Åke Norsten

ABSTRACT

With the growing use of solar energy for heating purposes, an increasing number of solar radiation measurements have to be made. As the measured data is used as a basis for dimensioning solar energy installations, it is of considerable economic importance that the measuring instruments should give reliable data.

This report describes an investigation which has had the dual aims of comparing the performance of a number of different makes of pyranometer and of determining a suitable level of delivery inspection and the degree of necessary regular calibration of the instruments.

The following makes and types of instrument have been examined: Eppley PSP, Kipp & Zonen CM5, Schenk Star 8101, Lintronic Dome 615, Lambda Li-Cor 200S and Hollis MR5. Linearity, tilt angle sensitivity, temperature dependence, cosine response and azimuth variations of the pyranometers were investigated, together with the effect of variations in solar spectral power distribution on the instruments. The instruments have also been calibrated outdoors and subjected to environmental tests.

Delivery inspection should cover all the above characteristics - at least for untested designs. Each instrument's levelling arrangements (spirit level) should be checked and, if necessary, adjusted, when checking the azimuth variations. Temperature dependence should always be measured, and correction should be applied if necessary when making the measurements. The instruments should be calibrated outdoors under conditions which are similar to those under which they will be working.

CONTENTS

1	INTRODUCTION
2	THE PYRANOMETERS
2.1	Eppley PSP
2.2	Kipp & Zonen CM-5
2.3	Philipp Schenk Star Pyranometer
2.4	Lintronic Dome 615 Pyranometer
2.5	Hollis Observatory MR-5
2.6	Lambda Instruments, Li-Cor 200S
3	LINEARITY
4	TILT ANGLE SENSITIVITY
5	TEMPERATURE DEPENDENCE
6	THE EFFECT OF ANGLE OF INCIDENCE (COSINE RESPONSE) AND AZIMUTH ANGLE
7	THE EFFECTS OF THE SOLAR SPECTRUM
8	OUTDOOR CALIBRATION
9	ENVIRONMENTAL TESTING
10	SPIRIT LEVEL SENSITIVITY
11	PYRANOMETER MEASUREMENT PERFORMANCE
12	SUMMARY OF INVESTIGATION RESULTS

CALIBRATION AND TESTING OF PYRANOMETERS

Hans E.B. Andersson

Leif Liedquist

Johan Lindblad

Lars-Ake Norsten

This report relates to Grant No. 791658-9 from the Swedish Council for Building Research to the Physical Measurements Laboratory of Swedish National Testing Institute, in Borås.

The increasing use of solar energy for heating purposes has resulted in a growing need for measurements of solar radiation. These measurements are used as a basis for dimensioning solar energy installations, and it is therefore essential that the performance of the measuring instruments is so well known that the results are not misleading. The instruments must be reliably calibrated, and their measurement performance and behaviour in general must be known. At the same time, there is an economic aspect: instruments must be sufficiently good for their purpose, without being more expensive than necessary.

The project which is the object of this report, and now concluded, had two aims: to investigate the basic parameters of some of the pyranometers available on the market, and to provide a basis for determining the degree of inspection which was necessary upon receipt of such instruments and during their regular calibration.

Two main types of detectors have been investigated. Instruments which have been most commonly used up to now have been of the thermal type, in which the sensitive element is a thermopile. These detectors have a responsivity which is almost independent of radiation wavelength within the solar spectrum range. Variations in the solar spectrum therefore have no measurable effect on the measured results. However, as the detector is thermal, any deviation from absolute level can affect calibration through convection above the sensing surface.

In recent years, pyranometers have been developed with semi-conducting silicon diode detectors. These detectors exhibit the normal spectral responsivity of the silicon diode, and can therefore measure radiation only up to a wavelength of about $1.1 \mu\text{m}$, while the solar spectrum has measurable intensities up to about $3 \mu\text{m}$. Further, the responsivity curve has a maximum at about $0.8 \mu\text{m}$, and falls off rapidly on each side of this wavelength. The result is that the variations which normally occur in the spectral distribution of solar radiation can lead to errors. However, in practice this type of instrument is insensitive to the effects caused by tilting.

The following characteristics have been investigated: linearity, cosine response, azimuth response, temperature dependence, spectral dependence of silicon detectors and tilt angle sensitivity. The instruments have also been compared by operating them in parallel outdoors for about a week. Finally, environmental tests have been carried out on some of the detectors, and the accuracy of their spirit levels has been measured.

The report contains summaries of the measurement results and a general discussion of the measurement properties and performance of the pyranometers, complemented by calculations of the expected measurement errors in the context of measuring incident energy throughout a day. Finally, the report makes suggestions for a suitable standard of delivery inspection and for methods of calibration, making due allowance for the use to which the instruments are to be put.

2 THE PYRANOMETERS

The following data is as given by the manufacturers for each of the pyranometers examined.

2.1 Eppley PSP

Manufacturer: Eppley Laboratory Inc., Newport, USA.

Type of detector: Thermopile

Model name: PSP (Precision Spectral Pyranometer)

Price: Approx. SEK 5500 (November 1980)

Serial nos: 15834F3, 15835F3, 14626F3

Calibration constants: 8.97 $\mu\text{V}/(\text{W} \cdot \text{m}^2)$ (15834F3)
8.99 $\mu\text{V}/(\text{W} \cdot \text{m}^2)$ (15835F3)
9.78 $\mu\text{V}/(\text{W} \cdot \text{m}^2)$ (14626F3)

Temperature dependence: $\pm 1\%$ (-20°C to $+40^\circ\text{C}$)

Linearity: $\pm 0.5\%$ (0 to $2800 \text{ W}/\text{m}^2$)

Cosine response: $\pm 1\%$ (0° to 70°)
 $\pm 3\%$ (70° to 80°)

Tilt angle sensitivity: Unaffected

Time constant: 1 s (1/e of the signal).

2.2 Kipp & Zonen CM-5

Manufacturer: Kipp & Zonen, Delft, Holland

Type of detector: Thermopile

Model name: CM-5

Price: SEK 4035 (November 1980)

Serial nos: 3643, 3644.

Calibration constant: 12.6 $\mu\text{V}/(\text{W} \cdot \text{m}^2)$ (3643)
12.3 $\mu\text{V}/(\text{W} \cdot \text{m}^2)$ (3644)

Temperature dependence: 0.15% per $^\circ\text{C}$

Linearity: 1% throughout the measuring range.

Time constant: 70% of final value within 3 s.
99% of final value within 30 s.

2.3 Philipp Schenk Star Pyranometer

Manufacturer: Philipp Schenk G.m.b.H Wien & Co., Wien.

Type of detector: Nickel-chromium-constantan thermopile with 72 soldered junctions, 6 black and 6 white zones in star pattern.

Model name: Star 8101

Price: ATS 7500, approx. SEK 2400 (May 1980)

Serial nos: 2046, 2057.

Calibration constant: $15.76 \mu\text{V}/(\text{W} \cdot \text{m}^2)$ (2046)
 $15.76 \mu\text{V}/(\text{W} \cdot \text{m}^2)$ (2057)

Temperature dependence: $\pm 0.03/\text{K}$.

Linearity: $\pm 1\%$ in the 30 to $1300 \text{ W}/\text{m}^2$ range.

Cosine response: $0-60^\circ < \pm 1\%$
 $60-80^\circ < \pm 3\%$

Tilt angle sensitivity: $\pm 1\%$ for $0-180^\circ$ inclination.

Time constant: 95% of the final value within 20 s.

2.4 Lintronic Limited, Dome 615 Pyranometer

Manufacturer: Lintronic Limited, London EC1A 7HB.

Type of detector: Thermopile, 40 soldered joints, produced by printed circuit methods.

Model name: Dome 615 Pyranometer.

Price: GBP 95, approx. SEK 830 (May 1980)

Serial nos: 1222A, 1993A.

Calibration constant: $11.67 \mu\text{V}/(\text{W} \cdot \text{m}^2)$ (1222A)
 $10.98 \mu\text{V}/(\text{W} \cdot \text{m}^2)$ (1993A)

Temperature dependence: $-0.2\%/^\circ\text{C}$.

Cosine response: $0-65^\circ \pm 2\%$
 $65-80^\circ \pm 4\%$

Time constant: 66% of the final value within 20 s.
99% of the final value within 3 min.

2.5 Hollis Observatory MR-5

Manufacturer: Hollis Observatory, Naskua, New Hampshire, USA.

Type of detector: Silicon diode.

Model name: MR-5

Price: USD 250, approx. SEK 1100 (May 1980).

Serial nos: 1995, 1996.

Calibration constant: $71.71 \mu\text{V}/(\text{W} \cdot \text{m}^2)$ (1995)
 $71.71 \mu\text{V}/(\text{W} \cdot \text{m}^2)$ (1996)

Temperature dependence: $\pm 1.5\%$ between -20°C and $+40^\circ\text{C}$,
temperature-compensated.

Linearity: $\pm 1\%$ from 0 to $1400 \text{ W}/\text{m}^2$.

Cosine response: $0-80^\circ \pm 1.5\%$.

Instrument no. 1995 was damaged when received and could not be used for the tests. It was not possible to obtain a replacement instrument within the time available for the project.

2.6 Lambda Instruments, LI-COR 200S

Manufacturer: Lambda Instruments Corp. (LI-COR Inc.), Lincoln, Nebraska, USA.

Model name: LI-COR 200S.

Price: Approx. SEK 800 (May 1980)

Serial nos: 2360, 2361.

Calibration constant: $8.00 \mu\text{V}/(\text{W} \cdot \text{m}^2)$ (2360)
 $8.20 \mu\text{V}/(\text{W} \cdot \text{m}^2)$ (2361)

Temperature dependence: $\pm 0.15\%/^\circ\text{C}$

Linearity: 1% up to $300 \text{ W}/\text{m}^2$.

Cosine response: Corrected up to 80° .

Detector linearity was measured throughout the range from about 1000 W/m^2 down to about 60 W/m^2 , using a step procedure. The detectors were irradiated from two projectors, first by one, then by the other, and then by both together. The projectors and detector were first positioned so that each projector caused the detector to generate a signal corresponding to about 500 W/m^2 . Both projectors together then produced a signal of about 1000 W/m^2 . The distance was then increased until the two projectors together generated a signal corresponding to about 500 W/m^2 , with each projector then giving about 250 W/m^2 . This procedure was repeated until each projector gave about 60 W/m^2 . The projectors were fitted with thermal filters which removed the greater part of the thermal radiation of the incandescent lamp (Figure 1).

The measured results are shown in Figure 2. The curves have been normalised to unity at 500 W/m^2 , i.e. it has been assumed that calibration has been carried out at about 500 W/m^2 and that the signal is therefore correct at this irradiance.

Several laboratories have carried out investigations into the sensitivity of pyranometers to deviations from exact level (see, for example, References 1, 2 and 3). The results have shown an unfortunate tendency to vary from author to author, which may be attributable to the methods used. The method which has been used here agrees essentially with that which is described in Reference 2, apart from the fact that an irradiance of about 450 W/m^2 was used in Reference 2 while we used about 1000 W/m^2 .

The pyranometer was mounted together with a projector, fitted with a thermal filter, on a swivelling optical bench. The radiation level was checked by a separate silicon diode type radiometer, the performance of which was unaffected by departures from level, to a stability of about $\pm 0.1\%$. Measurements were made at 10° intervals from horizontal (0°) to vertical (90°).

The results (Figure 3) agree in the relevant parts with those given in Reference 3. A comparison with Reference 2 concerning the CM-5 pyranometer shows the importance of making measurements at the radiation level for which the results are required. In this case, an irradiance of 1000 W/m^2 gave about twice the deviation as given by the 450 W/m^2 irradiance used in Reference 2.

Temperature dependence was investigated in a temperature-stabilised chamber. The detector was irradiated from outside the chamber by a projector which produced an irradiance corresponding to about 1000 W/m^2 , as measured by the detector under test. The detector was mounted horizontally in the chamber, and the radiation was vertically incident. The projector was supplied from a stabilised power source, and the electrical power was measured continuously. The radiation level from the projector was so stable that its variations did not affect the measured results.

A thermocouple was secured to the base of the instrument, and in good thermal contact with it. This enabled the temperature of the base to be controlled to within 0.1°C of the desired value. The detector signal was then measured every 30 seconds until it changed by less than 0.1% over a 20-minute period. When this stability had been attained, the value was recorded. The results are shown in Figure 4.

6 THE EFFECT OF ANGLE OF INCIDENCE (COSINE RESPONSE) AND ANGLE OF AZIMUTH

In order to measure the variation in responsivity with angle of incidence, the instrument was mounted vertically on a circular feed table and irradiated horizontally by a stable radiation source (a xenon lamp). The as-measured signal was compared with the signal for perpendicular incidence multiplied by the cosine of the angle of incidence β_i . The values shown in Figure 5 thus represent:

$$\frac{V(\beta_i)}{V(\beta_i=0) \cdot \cos(\beta_i)}$$

where $V(\beta_i)$ is the measured signal at angle of incidence β_i .

In order to measure the azimuth dependence of the responsivity, the instrument was mounted horizontally on a circular feed table and irradiated with collimated radiation (from a projector with a halogen bulb and thermal filter) from two angles of incidence, 45° and 75° , corresponding to solar elevations of 45° and 15° when the pyranometer is horizontally mounted. Horizontal alignment of the instrument was carried out using the instrument's own spirit level. Figure 5 shows the signal as normalised to the azimuth angle (180°) which corresponds to southward orientation when the pyranometer cable connection is run to the north. The azimuth angle has been measured from the north round towards the east ($90^\circ = \text{east}$, $270^\circ = \text{west}$).

For both sets of measurements, each measured value was recorded a certain time after the respective angle had been set. This time delay was considerably longer than the instrument's time constant. In several cases it is quite apparent that variations in responsivity as a function of azimuth angle result from poor levelling. See Chapter 10.

The sensitivity range of silicon detectors extends from about 0.3 μm to about 1.1 μm , while the solar spectrum extends from about 0.3 μm to about 2.5-3.0 μm . The long wavelength boundary is not sharp, but about 99% of the energy in the solar spectrum lies below 2.5 μm . About 75% of the energy in the solar spectrum lies within the sensitivity range of the silicon detector.

In spectral terms, the silicon detector thus measures only part of the radiant energy, with the result that any changes in the spectral power distribution, as compared with the particular distribution at the time of calibrating, can give rise to measurement errors. The object of this investigation was to estimate the magnitude of errors of this type. The spectral responsivity of the detectors was measured, and the results are shown in Figures 6a - 6c. By weighting these responses against the solar spectrum, a quantity is obtained which is proportional to the signal from the detector when it is irradiated with radiation of the corresponding spectral power distribution. If $D(\lambda)$ is the spectral responsivity of the detector and $S(\lambda)$ is the spectral power distribution of the solar spectrum, then the sought quantity, D , is given by:

$$D = \frac{\int D(\lambda) S(\lambda) d\lambda}{\int S(\lambda) d\lambda} \quad (1)$$

Figure 7 shows the spectral power distributions, $[S(\lambda)]$, obtained from Reference 4. These spectral power distributions are standard distributions, originally published by Gates (Ref. 5), and valid for air masses of 1.0, 1.5, 2.0 and 4.0 for both direct and global radiation.

The spectral power distributions as shown in Figure 7 have been extrapolated linearly in the calculations from the value at 1.8 μm to 0 at 3 μm .

Table I - Nomenclature for spectra as used.

mG ₁	=	spectrum for air mass 1,	global radiation
mD ₁	=	" " 1,	direct radiation
mG _{1.5}	=	spectrum for air mass 1.5,	global radiation
mD _{1.5}	=	" " 1.5	direct radiation
mG ₂	=	spectrum for air mass 2,	global radiation
mD ₂	=	" " 2,	direct radiation
mG ₄	=	spectrum for air mass 4,	global radiation
mD ₄	=	" " 4,	direct radiation

Table II - Approximate solar elevations corresponding to the air masses in Table I.

Air mass	Solar elevation
1	90° (definition)
1.5	approx. 42°
2	approx. 30°
3	approx. 20°
4	approx. 14°

Table III - Relative responsivity of silicon detectors
when measuring solar radiation corresponding
to different air masses

Spectrum	Approx. solar elevation	Relative responsivity			Linear response
		200S No 2360	200S No 2361	MR-5 No 1996	
mG ₂		1.000	1.009	0.983	1.085
mG ₁	90°	0.920	0.919	0.911	0.928
mG _{1.5}	45°	0.923	0.923	0.920	0.919
mG ₂	30°	1.000	1.000	1.000	1.000
mG ₄	14°	0.955	0.955	0.958	0.963
mD ₁	90°	0.915	0.914	0.912	0.901
mD _{1.5}	45°	0.939	0.937	0.945	0.906
mD ₂	30°	1.026	1.025	1.043	0.974
mD ₄	14°	1.015	1.012	1.060	0.910

In Table III, the first line represents the responsivity as calculated for the mG₂ spectrum for the three detectors investigated and for a postulated detector with a linear response in the spectral sensitivity range of silicon detectors. It should be noted that the calculations indicate only the differences due to changes in the spectral responsivity between the various detectors.

Table III also shows the relative responsivity for each detector when measurements are made of radiation with a spectral power distribution which corresponds to the air masses in Table I.

The calculation results as shown in Table 3 indicate that a detector of this type, calibrated at a solar elevation of about 30°, can give erroneous readings of several for both higher and lower solar elevations, caused by changes in the spectral power distribution of the radiation.

8 OUTDOOR CALIBRATION

The instruments were mounted on a horizontal table on the roof of the laboratory, and connected to a data-logging system. Measured values were read off every minute, and all twelve instruments were read in about 6 seconds. Hourly average values were calculated and stored, and measurements continued for about a week.

An average value of responsivity has been calculated for each detector from the hourly average values, using the Eppley PSP-15834F3 as reference. Only irradiances greater than 200 W/m² have been used. Any measured values which deviated by more than 10% from the first average value were eliminated during processing, and a new average value was calculated.

The responsivity of the reference detector for perpendicularly incident radiation is $8.75 \mu\text{V}/(\text{W} \cdot \text{m}^2)$. This value has been obtained after repeated calibrations against the National Testing Institute's Primary Standard for Solar Radiation Irradiance, an absolute pyrheliometer, both in Borås and at the WRC (World Radiation Center) in Davos. The National Testing Institute's absolute pyrheliometer can be related to the WRR (World Radiation Reference) through the international comparison between pyrheliometers which was carried out at WRC in October 1980.

Solar elevation during the measurement period was about 30° (i.e. about 60° angle of incidence). The responsivity of the reference detector was therefore corrected for deviation from perfect cosine response, and the value of $8.49 \mu\text{V}/\text{W}/\text{m}^2$ was used for the calculations. The results are shown in Table IV.

Table IV - Results of outdoor calibration.
Reference: Eppley PSP-15834F3.
=====

Detector		Responsivity $\mu\text{V}/(\text{W} \cdot \text{m}^2)$ according to manfr.	as measured	No. of measured values	Correctn. factor	s for correcn. factor
Eppley	PSP-15834F3	8.99	8.49	-	0.944	-
Eppley	PSP-15835F3	8.97	8.55	28	0.943	0.013
Eppley	PSP-14626F3	9.78	8.98	45	0.918	0.013
Kipp & Zonen	CM5-3643	12.6	11.15	44	0.885	0.009
Kipp & Zonen	CM5-3644	12.3	11.36	45	0.924	0.009
Schenk Star	8101-2046	15.76	14.91	44	0.946	0.016
Schenk Star	8101-2057	15.76	14.76	44	0.936	0.012
Lintronic	Dome-1222	11.67	10.81	41	0.926	0.047
Lintronic	Dome-1993	10.98	10.56	41	0.962	0.047
Lambda, Li-Cor	200S-2360	8.0	8.03	41	1.004	0.023
Lambda, Li-Cor	200S-2361	8.2	8.16	43	0.995	0.018
Hollis	MR-5-1996	71.71	73.24	44	1.021	0.023

In Figure 8, the responsivity relative to the Eppley PSP-15834F3 pyranometer has been shown as a function of temperature, irradiance, solar elevation and azimuth angle, without the above-mentioned restriction on measured values.

It is possible to draw a number of general conclusions from the outdoor calibration:

- The manufacturer's calibration can be up to 5-10% out. This does not necessarily mean that their calibration level is wrong, but can arise from the fact that the calibration situation differed excessively from the measuring situation.
- If the calibration constant is to have a realistic value for a given measurement, the radiation conditions should be allowed to vary within certain limits which are realistic in view of the proposed application of the pyranometer, i.e. the comparison should be carried out over several days with varying weather conditions.
- The actual measurement performance of the reference detector must be well known, and corrections must be applied where possible. If this is not done, any shortcomings in the reference detector results will be transferred to the detector being calibrated.
- When choosing the measured values for calculating the final value for calibration constant, extreme values should be disregarded (as they are probably associated with significant errors). The median of the values should lie within the most commonly occurring ranges of temperature, irradiance, solar elevation and azimuth angles. For further details of the problem, see Chapter 10.

9 ENVIRONMENTAL TESTING

The following environmental tests were carried out, in accordance with IEC Publication No. 68:

1. Heat soak for 24 hours at 40°C.
2. Cyclic moisture test for 24 hours, 25-55°C, 90-100% relative humidity. Cycle length, 24 hours.
3. Freezing for 16 hours at -25°C.
4. Cyclic moisture test for 5 days, in accordance with (2) above.

The detectors were checked before and after the tests. Visual inspection did not reveal any damage to any of them. The changes in responsivity were less than the resolution of the method of checking (1%), except for the Li-Cor 200S, for which the change amounted to +2% for one instrument and +6% for the other. It has not been possible to find any proven explanation for this change.

It was mentioned in Chapter 6 that several of the pyranometers exhibited a solar azimuth dependence, due to the fact that they had poorly adjusted spirit levels. However, another reason for this effect might be that the sensitivity of the spirit levels to angular changes around the horizontal position was so poor that the observed azimuth dependency arose from the fact that the instrument could not be set up horizontally with a sufficient degree of accuracy. This sensitivity was measured on each instrument by adjusting it until the spirit level indicated horizontal alignment, and then inclining the instrument until the spirit level bubble was displaced about 0.5 mm, which gave a clear indication of incorrect setting. The angular difference between these two positions was measured for a number of different directions of misalignment.

0.5 mm displacement of the spirit level bubble corresponded to the following respective angular changes:

- | | |
|--|------|
| - Li-Cor 200S, Hollis MR5, Kipp + Zonen CM5
and Eppley PSP: | 0.2° |
| - Star 8101: | 0.1° |
| - Lintronic Dome 615: | 0.4° |

The results show that the spirit levels have adequate resolution. It is therefore reasonable to assume that the large azimuth angle dependent effects observed result from badly adjusted spirit levels.

For an ideal radiation detector, the relationship between the output signal V and the incident radiation or irradiance E (the responsivity) can be described by a constant factor K , i.e.

$$V = K \cdot E \quad (11.1)$$

For a real (i.e. = non-ideal) detector of the pyranometer type, several corrections are necessary to compensate for shortcomings in the detector. The expression in Equation 11.1 could be complemented by a correction function Ψ , which is a function of several parameters and, in certain cases, of combinations of these parameters:

$$V = K \cdot \Psi [\cos(\beta_i), \phi, E, T, \tau, \lambda, \beta_\ell, t] \cdot E \quad (11.2)$$

In Equation 11.2, the following nomenclature is used:

$\cos(\beta_i)$	dependence on the angle of incidence of the radiation, β_i .
ϕ	variations with angle of azimuth
E	linearity with radiation level
T	temperature dependence
τ	the detector time constant
λ	the effect of variations in radiation spectral power distribution
β_ℓ	tilt angle dependence
t	time dependence (ageing).

Several parameters sometimes act together to change the effect of one particular given parameter on the measured results. The effect of the angle of incidence (cosine response), for instance, can vary with azimuth angle, with the result that the output signal is affected by the geometrical distribution of the radiation over the hemisphere. In turn, the geometrical distribution of the radiation depends upon other factors, among them being the solar elevation, which in its turn affects both the spectral power distribution and the irradiance E . The relationship between solar elevation and temperature makes the situation even more complex.

In silicon diode detector type pyranometers, the spectral distribution of the responsivity is often temperature-dependent, with the result that the detector's response to radiation having a given spectral power distribution, is affected by the ambient temperature.

For thermal pyranometers, it is possible to observe the effect of sky temperature, over and above the influence of the parameters given in Equation 11.2, in that it affects the radiation balance of the glass dome of the detector (Reference 6). Polarisation of the radiation could also affect the output signal (Reference 7).

If a pyranometer is to be of practical use, it must be possible to ignore the effects of several of these parameters. For other parameters, it is sufficient if their effects can be isolated and quantified, so that corrections can then be applied during measuring.

In practice, it is very difficult to correct for the effects of λ , $\cos(\beta_j)$, ϕ and τ among the parameters in Equation 11.2. The spectral power distribution of the radiation can vary in many ways, and it is not possible to describe this variation by means of any single parameter. Nor is it possible to correct by any simple means for the variation in responsivity with the angle of incidence or azimuth angle of the radiation. The geometric distribution of the radiation is far too variable.

It is therefore necessary to require that the spectral responsivity of the detector should be sufficiently constant throughout the wavelength range, i.e. that the detector output signal should be practically independent of the variations which can occur in the spectral power distribution of solar radiation.

The relationship between the angle of incidence of the radiation, β_j , and the responsivity of the detectors should also be sufficiently close to a cosine function, i.e. $\cos(\beta_j)$. The responsivity should also be independent of the azimuth angle of the radiation.

It is possible to deal with the sensitivity of thermal detectors to tilt angle deviations (i.e. to the slope angle β_2), by ensuring that the detector has the same 'level' during calibration as it will have in use.

Linearity and temperature dependence can be measured and corrections can be applied. However, it is naturally better for measurement accuracy if these corrections are small.

The time constant τ of the detector determines its ability to follow variations in incident radiation level. If the detector has a time constant which is long compared with the radiation variation time, it can even out radiation variations and register average values over periods of time which are long compared with the intensity/time variations of the radiation. However, the converse of this is that instantaneous values are nearly always incorrect.

During periods of varying cloud cover, the variation times of solar radiation can be as short as a tenth of a second. Silicon diode detectors have time constants measured in microseconds, and can therefore follow such radiation fluctuations without difficulty.

For the thermal detectors, measurement of such rapid changes is more complicated. These detectors are assembled from series-connected thermocouple elements forming a thermopile which has a hot and a cold junction in the usual way. The hot junction has good thermal contact with the radiation receptor and has a time constant of a few seconds. It can therefore give rise to a certain levelling-out of incident radiation variations but should not cause any errors in the average values of irradiance.

The cold junction can have two different possible positions, resulting in somewhat different detector properties. In detectors of the type which, in the investigation, were represented by the Eppley PSP, Kipp & Zonen, CM5 and Lintronic Dome 615 pyranometers, the cold junction is in good thermal contact with the body of the pyranometer casing. This gives the junction a time constant with respect to changes in the ambient temperature which can be of the order of half an hour to an hour.

Let us assume that the detector is calibrated for each ambient temperature when it is in thermal equilibrium with its surroundings, represented by the air temperature and the radiation level. The hot junction is in thermal equilibrium with the solar radiation (which raises its temperature) and also, through the glass dome, with the air and the sky radiation (which lower its temperature). The cold junction is in thermal equilibrium, via the pyranometer mounting, with the surrounding air.

If the air temperature changes significantly while measurements are being made in a time which is short compared with the time constant of the cold junction, the hot junction will follow the air temperature change considerably more rapidly than the cold junction, with incorrect measurement as a result. This phenomenon caused measurement problems when measuring the temperature dependence of the detectors as described in Chapter 5. The error could amount to 2-3%, which must be regarded as a maximum possible error, as the rate of change of temperature in the climate chamber was more rapid than that which normally occurs outdoors. This problem might become acute during periods of varying cloud cover and brief rain showers, which could cause the temperature of the glass dome to vary considerably more than the temperature of the cold junction.

Pyranometers of the black-and-white type, represented in these tests by the Star 8101, have both junctions in contact with the front surface, with the hot junction being painted black and the cold junction being painted white. The result is that the cold junction has almost the same response to changes in the air temperature as the hot junction, which was demonstrated during measurement of the temperature dependence of the detectors.

In black-and-white pyranometers, multiple reflection inside the glass dome can give rise to errors which are not present in the black type of pyranometer (Reference 6). The black and white fields have very different reflectances, with the result that the reflection pattern inside the dome can differ, depending on whether a black or white section of the field happens to be facing towards the radiation source, with the result that the responsivity is dependent upon the angle of azimuth ϕ . However, the measurements described in Chapter 6 show that the responsivity of the Star 8101 has no greater azimuth dependence than that of the other pyranometers.

If it is wished to evaluate the effect of performance deviation of a detector from an ideal detector, it is necessary to make allowance for how, and for what purpose, the detector will be used. Pyranometers are used in solar energy projects for measurement of incident solar energy over days, months or years. What is important, therefore, is the effect of measurement error on the as-measured energy during, say, one day.

The as-measured solar radiation per m^2 on a clear day can be calculated from integration of Equations 11.1 or 11.2 with respect to time. If we assume that the function Ψ_1 corrects for a certain shortcoming of the detector, e.g. the cosine response, the integral acquires the following form:

$$W = K \int \Psi_1 dt \quad (11.3)$$

where Ψ_1 is a function of the angle of incidence of the radiation, which in its turn is a function of the time of day.

If, instead, we wish to investigate how some given shortcoming of the detector affects the measurement results, an error function F can be introduced, whereupon:

$$W = K \int F dt \quad (11.4)$$

Let us assume that the incident radiation on a clear day varies with time in accordance with a sine function, and that we integrate from sunrise to sunset. The signal from an ideal detector would then vary in accordance with the expression $V = V_0 \sin \alpha$, where the angle α varies from 0° to 180° .

The dependence of the responsivity upon the angle of incidence can be approximated with a formula of the type:

$$F = (b + cx) [1 - \exp(-ax)] \quad (11.5)$$

where x is ($90^\circ -$ the angle of incidence), i.e. an angle equal to the solar elevation.

Further, assume that the maximum solar elevation during the day is 50° . Equations 11.4 and 11.5 then give the following expression for W :

$$W = K V_0 \int (b + cx) [1 - \exp(-ax)] \cdot \sin(1.8x) dx \quad (11.6)$$

This expression should then be integrated from 0° to 50° , which represents integration from sunrise ($1.8x = 0^\circ$) to midday ($1.8x = 90^\circ$). The symmetry in the mathematical model repeats the process during the afternoon.

Table V shows the results of calculations made using Equation 11.6 with data which approximately agrees with that as measured for the detectors in the investigation.

Table V - The effects of cosine response on the measured energy during a cloudless day, as compared with measured values from an ideal detector.

<u>Detector</u>	<u>Relative energy</u>
<u>Calibration at 0° angle of incidence</u>	
Eppley PSP	0.96
Kipp & Zonen CM5	0.94
Star 8101	0.98
Lintronic Dome 615	0.93
Li-Cor 200S, Hollis MR-5	0.996
<u>Calibration at 40° angle of incidence</u>	
Eppley PSP	0.99
Kipp & Zonen CM5	0.99
Star 8101	0.99
Lintronic Dome 615	0.94
Li-Cor 200S, Hollis MR-5	0.996
<u>Calibration at 60° angle of incidence</u>	
Eppley PSP	1.00
Kipp & Zonen CM5	1.01
Star 8101	1.00
Lintronic Dome 615	0.97
Li-Cor 200S, Hollis MR-5	0.996

It is found that the deviation from ideal cosine response, which is exhibited even at relatively small angles of incidence by the Eppley PSP and Kipp & Zonen CM5, has a considerable effect on the measured results. What was not expected is that the apparently very poor response of the Lintronic Dome 615 does not result in much worse performance. A considerable improvement can be brought about by ensuring that the instruments are calibrated at some angle of incidence which corresponds to that likely to be encountered in normal use.

Formulae similar to that in Equation 11.5 are given in Reference 8, where azimuth dependence, too, has been introduced into the formula.

The relative responsivity of the silicon detectors as a function of solar elevation is shown in Table III. It can be seen that the responsivity rises in the 0°-30° range, and is almost constant over the 45°-90° range. In between, (30°-45°), there is a transition range in which the responsivity falls. A responsivity which is dependent upon solar elevation must therefore be expected when the detectors are calibrated.

What is of interest is the magnitude of this effect on the energy as measured over a whole day. We can use Equation 11.3, and divide the integration range into three smaller ranges so that:

$$\begin{aligned} \psi_1 &= 0.92 + 0.153 x && \text{for } 0^\circ \leq x \leq 30^\circ \\ \psi_1 &= 1.16 - 0.306 x && \text{for } 30^\circ < x < 45^\circ \\ \psi_1 &= 0.92 && \text{for } 45^\circ < x \leq 50^\circ \end{aligned}$$

where x is an angle equal to the solar elevation. Here, too, the maximum solar elevation is assumed to be 50°. The result of the calculations are shown in Table VI.

Table VI - The effects of changes in solar spectral power distribution, caused by varying solar elevations, on the as-measured incident energy during one day, when using a silicon diode pyranometer.

	Relative as-measured energy
Calibration coefficient varying with solar elevation	1.00
Calibration at solar elevation 30°	1.04
Calibration at solar elevation 45°	0.96
Calibration at solar elevation 15° or 35°	1.00

The results in Table VI must be seen as an arithmetical example. Variation in the spectral power distribution of solar radiation occurs due to a number of effects, and not only due to changes in the air mass, and many factors can play their parts. However, it is clear that incorrect measurements of incident energy of up to several percent can occur when using silicon diode pyranometers due to the effects of variations in the incident radiation spectrum. It is also clear that the responsivity, as measured during calibration, can vary by several percent due to variations in the spectral power distribution of the radiation at the time of calibration as compared to similar calibration measurements made at some other time.

This investigation has shown that:

- manufacturers' calibration constants can exhibit quite considerable uncertainties. This is particularly noticeable if the calibration situation is matched to the potential use situation. Measurement errors of 5-10% are not uncommon.
- linearity errors can occur in both thermal and silicon diode detectors.
- non-temperature-compensated detectors can exhibit measurement errors of several percent when operated at temperatures substantially different from the calibration temperature.
- deviations from perfect cosine response can result in serious measurement errors. This deviation is particularly critical at small angles of incidence.
- poorly adjusted spirit levels can result in azimuth variations in the responsivity of 5-10%.
- for silicon diode detectors, variations in the solar spectrum can result in measurement errors of up to 10%.
- tilt angle responsivity dependence varies widely from one manufacturer to another.

Pyranometers should be checked when supplied and then recalibrated at regular intervals.

Delivery inspection is naturally particularly important in connection with a change to another type of instrument which has not previously been examined and/or used. Such inspection should include linearity, temperature dependence, cosine response and responsivity azimuth variations. If the azimuth variations are large, the spirit level should be adjusted. Depending on the use to which the pyranometer is to be put, it may also be necessary to investigate the tilt angle dependence. Minimum requirements should be established for any given type of application.

Calibration should be performed outdoors by comparison with a reference detector of which the characteristics and behaviour are well known, and should continue for about a week with varying weather conditions.

Testing the pyranometer at the exact inclination at which it will subsequently work has two advantages. Measurement errors due to tilt angle dependence are eliminated, and a certain degree of compensation for non-ideal cosine response is introduced by the effect of the incident angles of radiation being essentially the same as those encountered during operational use. This applies, too, to variations in the azimuth angle.

Temperature dependence should be measured separately and corrections for air temperature should be applied at the time of measurement. The temperature variations which can occur during the calibration week are unlikely to cover the entire range of variations which occur in practical use.

Attempts have been made to find a relationship between the responsivity and several performance-affecting parameters through the application of multiple regression analysis (Reference 9). However, it is doubtful if the results can be of practical application, due to such mechanisms as the cross-correlations mentioned in Chapter 10. Nor has it been possible to include any such investigation within the framework of the project described here.

Silicon detector pyranometers can be used, but it must be realised that there will be greater inaccuracy of measurement than would be produced by good-quality thermal pyranometers, due to the limited spectral sensitivity range of the silicon detector.

LITERATURE

1. Norris, D.J., Calibration of pyranometers in inclined and inverted positions, Solar Energy, Vol 16, pp 53-55, 1974.
2. Flowers, E.C., Comparison of Solar Radiation Sensors from Various Manufacturers, National Oceanic and Atmospheric Administration, Environmental Research Laboratories, Solar Radiation Facility, Boulder, CO 80302.
3. Dehne, K., Results of indoor test of solarimeter specifications. Deutscher Wetterdienst, Meteorologisches Observatorium, Hamburg. Lecture at WRC, Davos, October, 1980.
4. Henderson, S.T., Daylight and its spectrum, second edition, Adam Hilger Ltd., Bristol 1977.
5. Gates, D.M., Science, Vol 151, No 3710, pp. 523-529, 1966.
6. Bahm, R.J. and Nakos, J.C., The calibration of solar radiation measuring instruments, Report No BER-1(79) DOE-684-1, The Bureau of Engineering Research, The University of New Mexico, Albuquerque, New Mexico 87131, November 1979.
7. Wyatt, C.L., Radiometric calibration: Theory and Methods. Academic Press, New York 1978.
8. Plazy, J.L. and Coudert R., Estimation des incertitudes lors de l'étalonnage des pyranometres. Ministère des Transports, Direction de la Météorologie, Paris, septembre 1980.
9. Norris, D.J., Calibration of pyranometers. Solar Energy, Vol 14, pp. 99-108, 1973.



Figure 1

The radiation spectrum of the projector compared with airmass-2 solar spectrum.

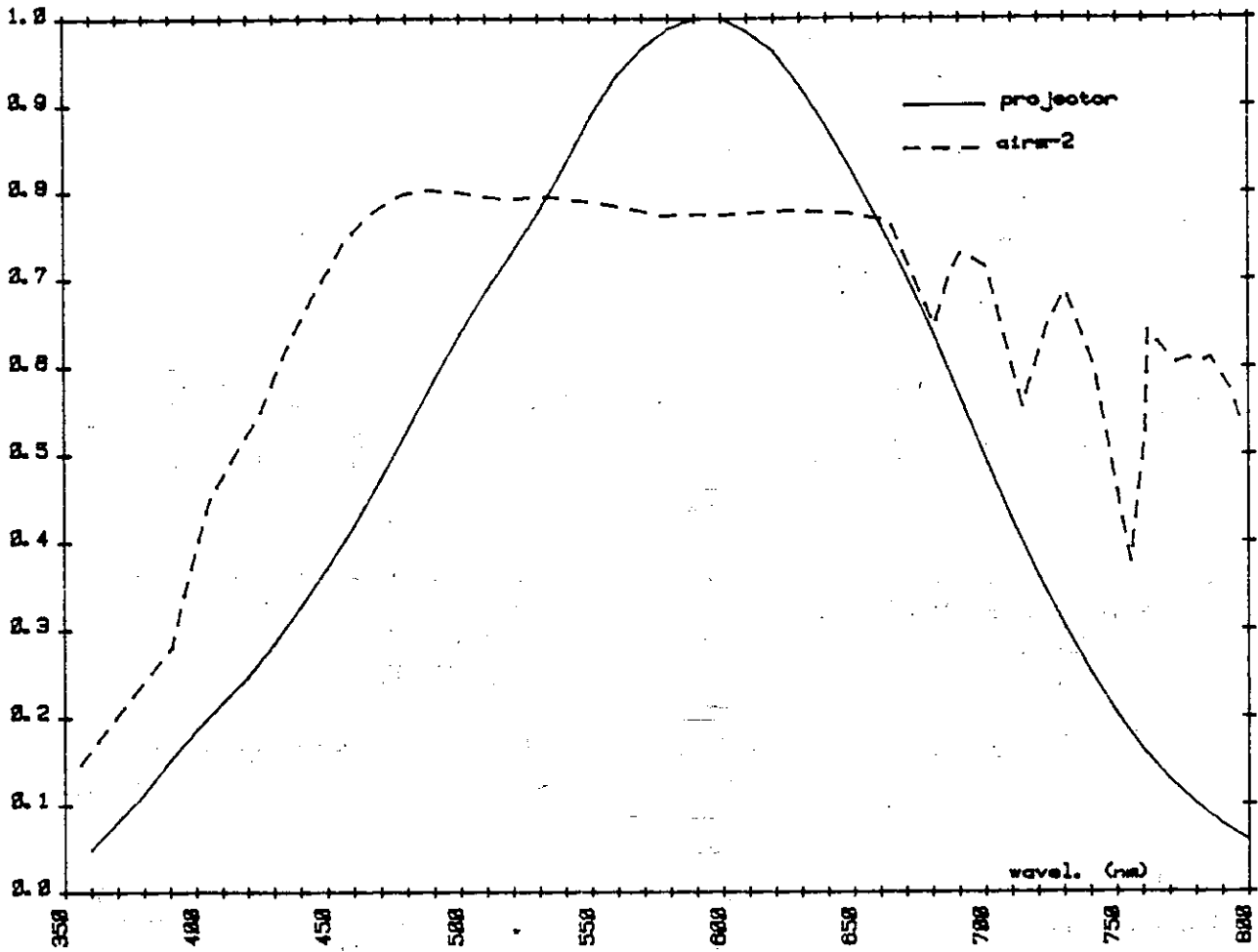



Figure 2

LINEARITY WITH IRRADIANCE:
DEVIATION FROM LINEAR RESPONSE

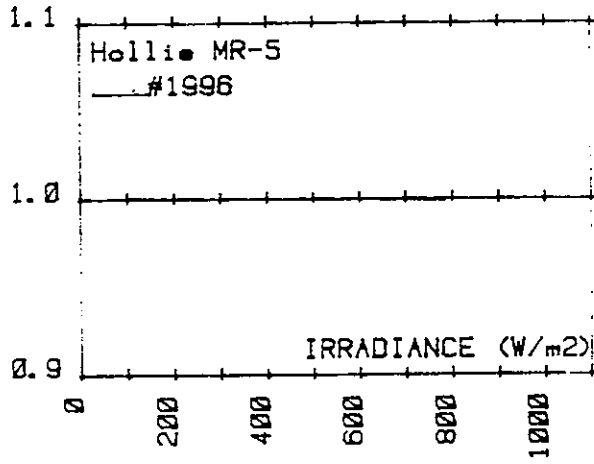
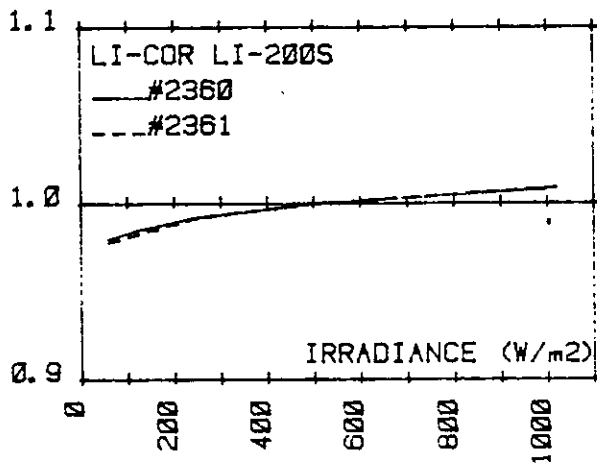
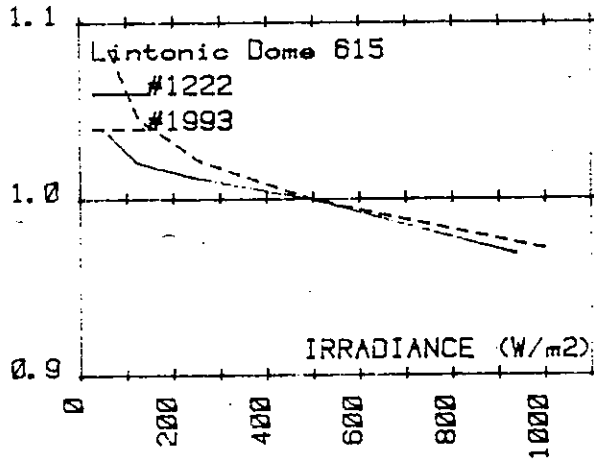
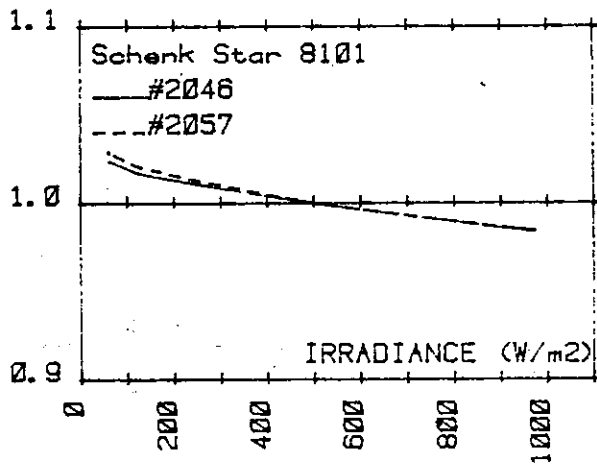
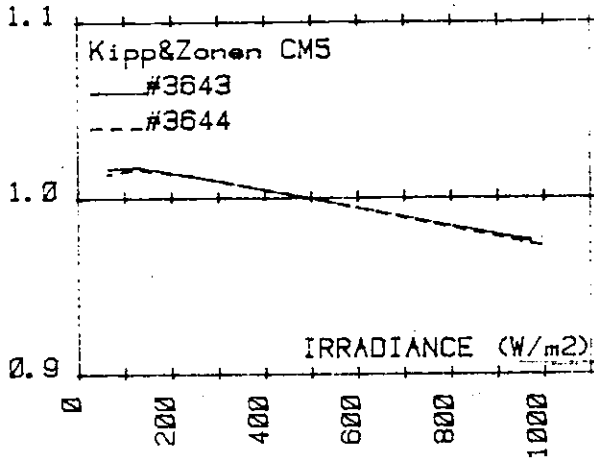
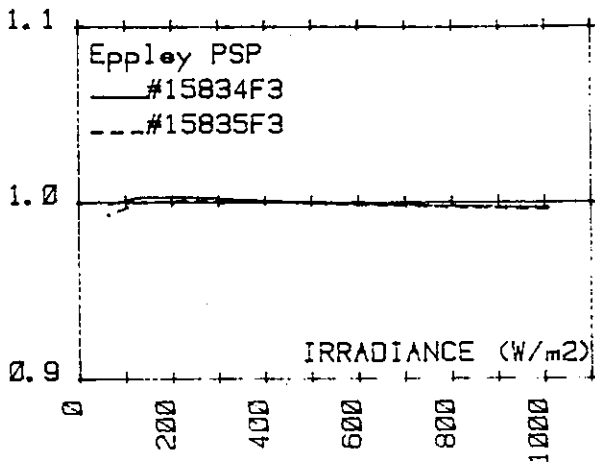



Figure 3

RESPONSIVITY VARIATION WITH TILT ANGLE

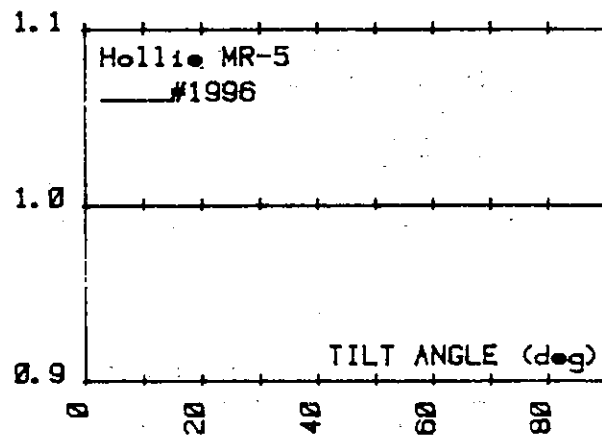
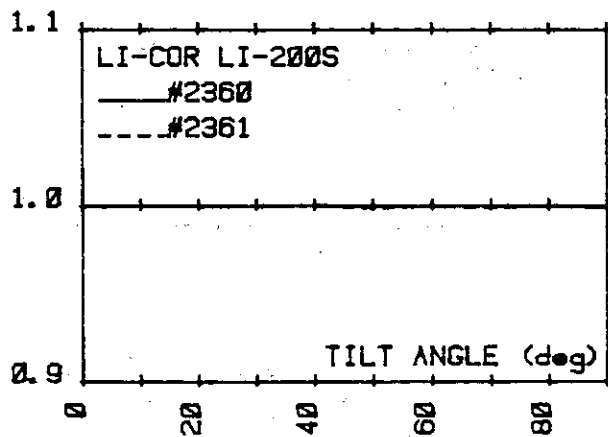
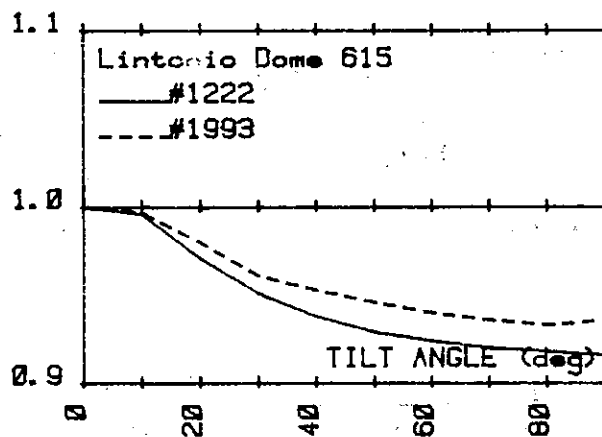
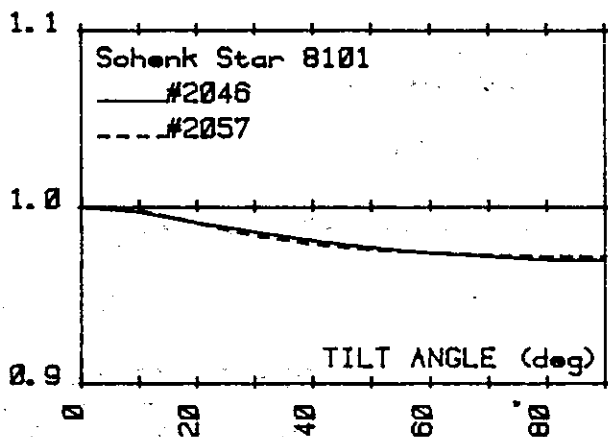
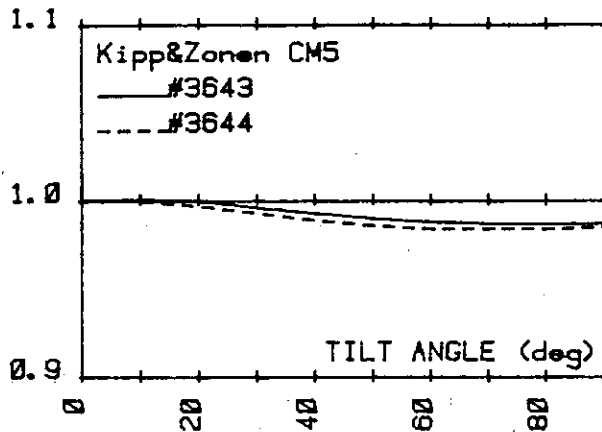
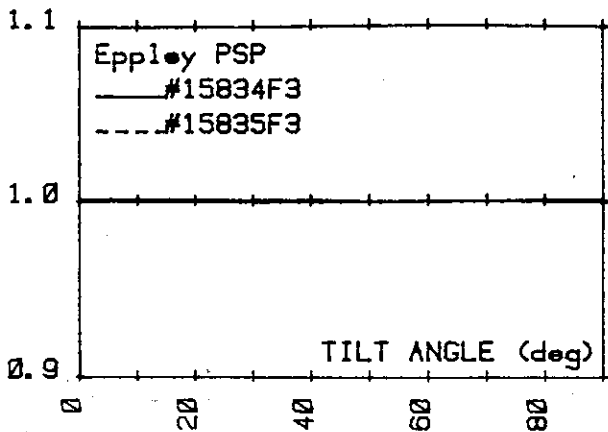

Figure 4
RESPONSIVITY VARIATION WITH TEMPERATURE

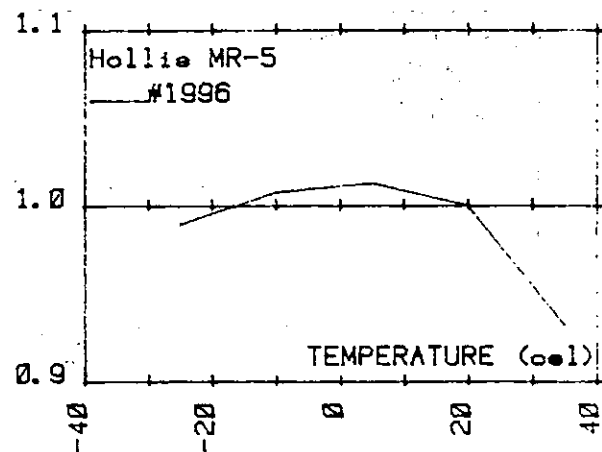
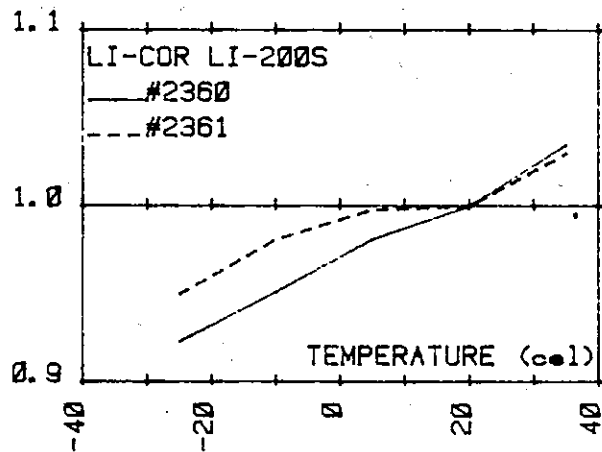
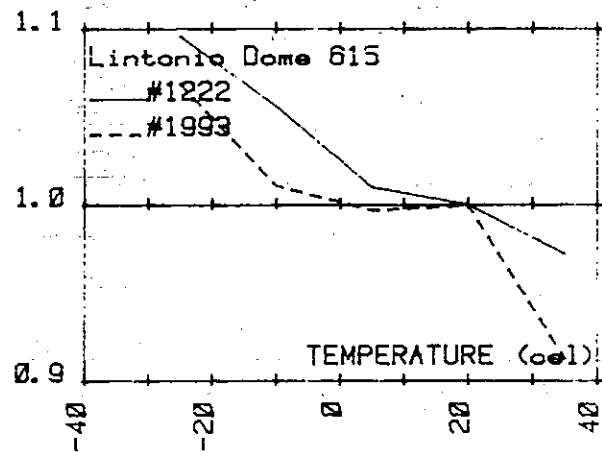
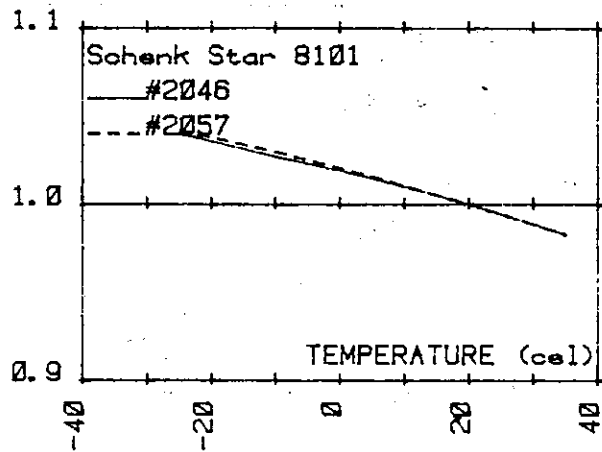
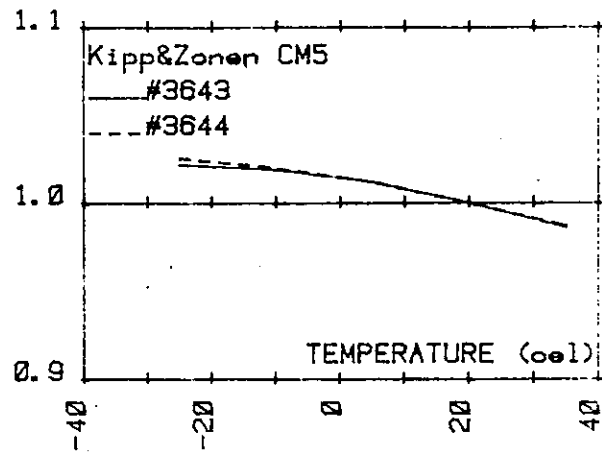
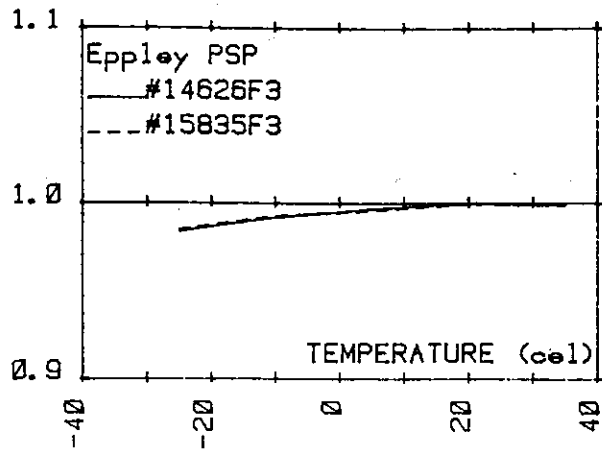
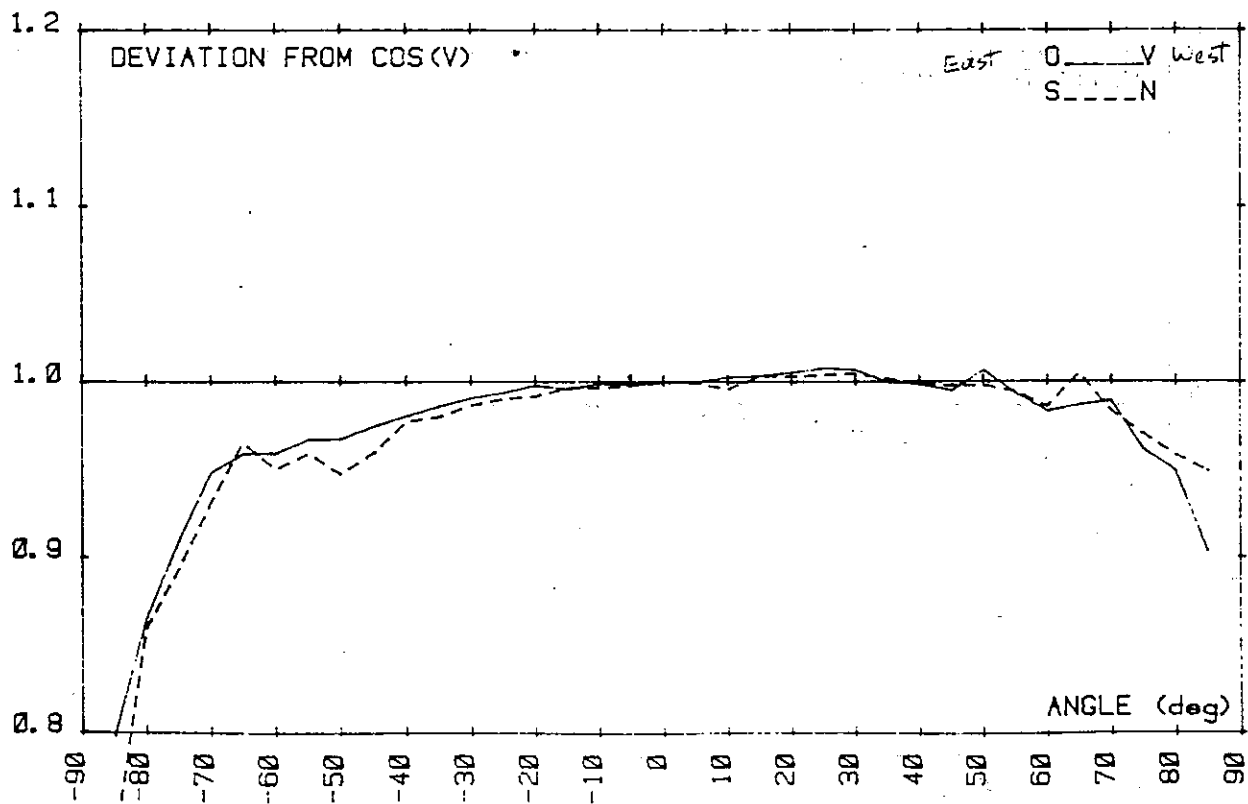
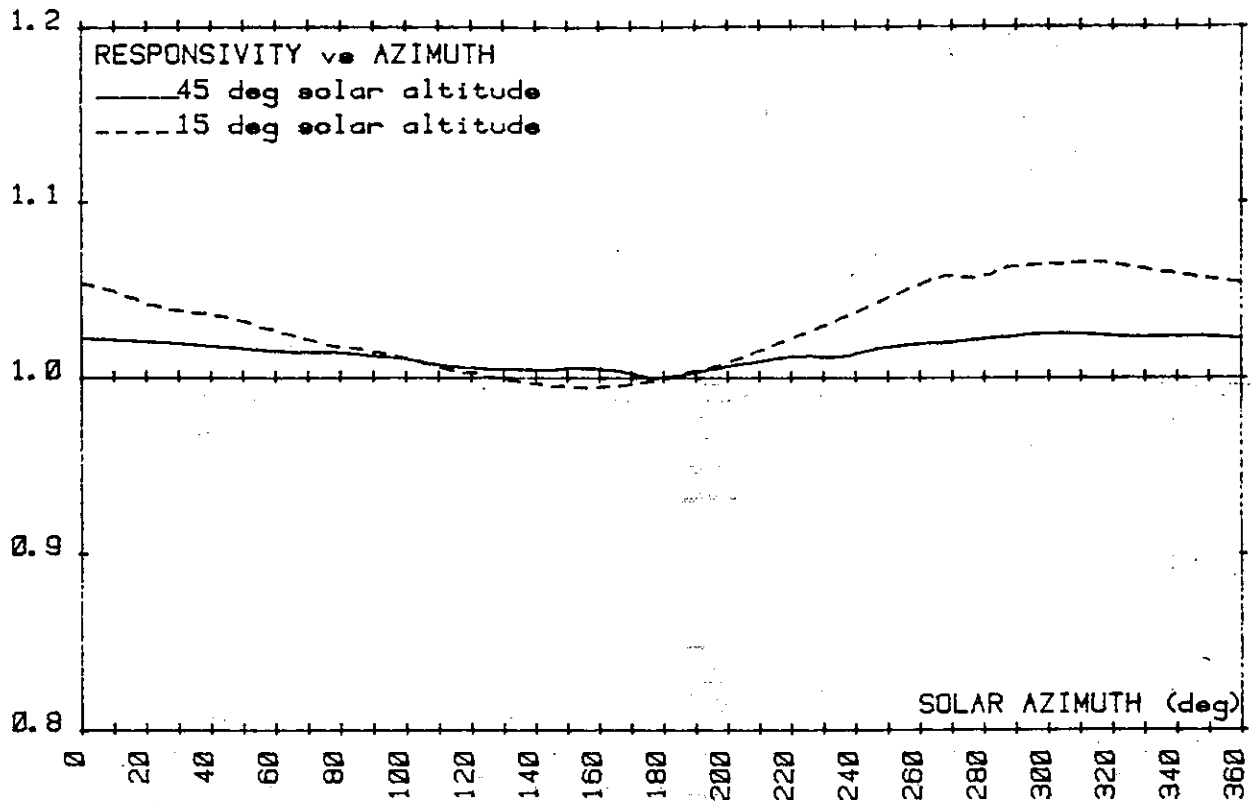

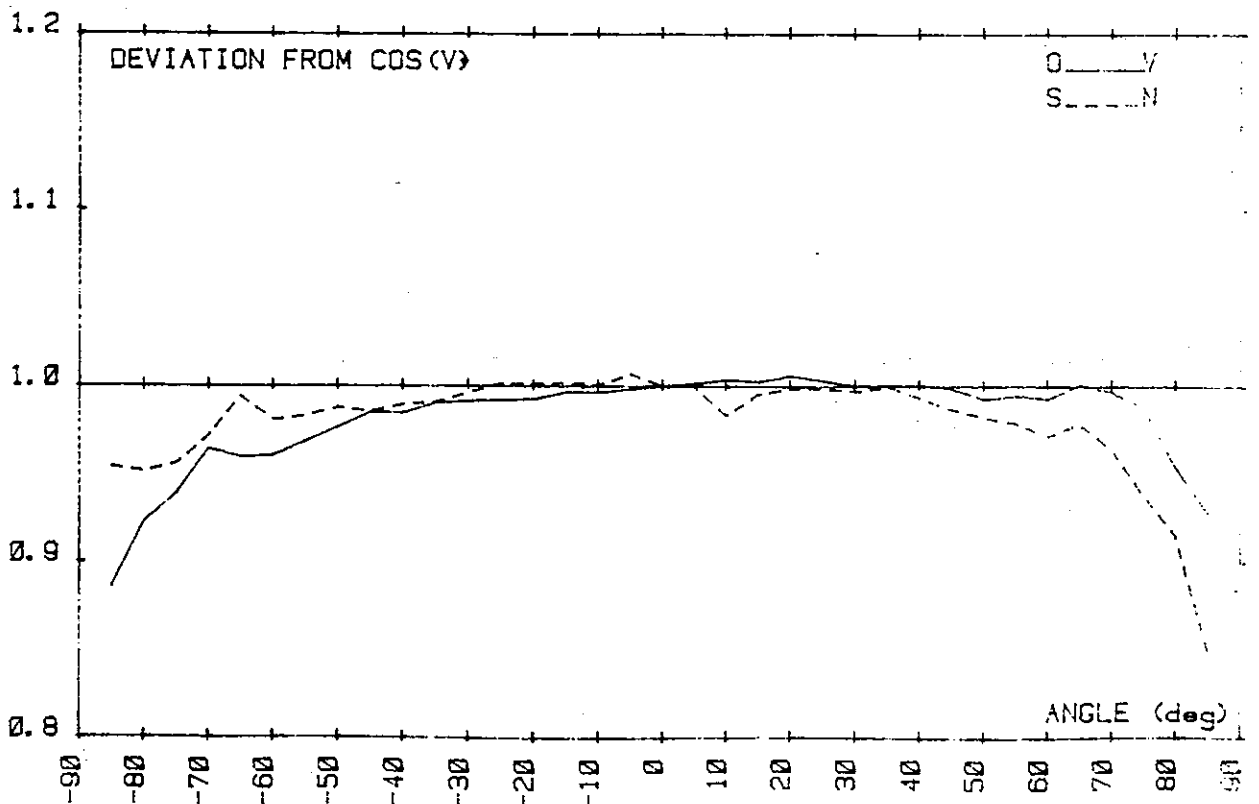
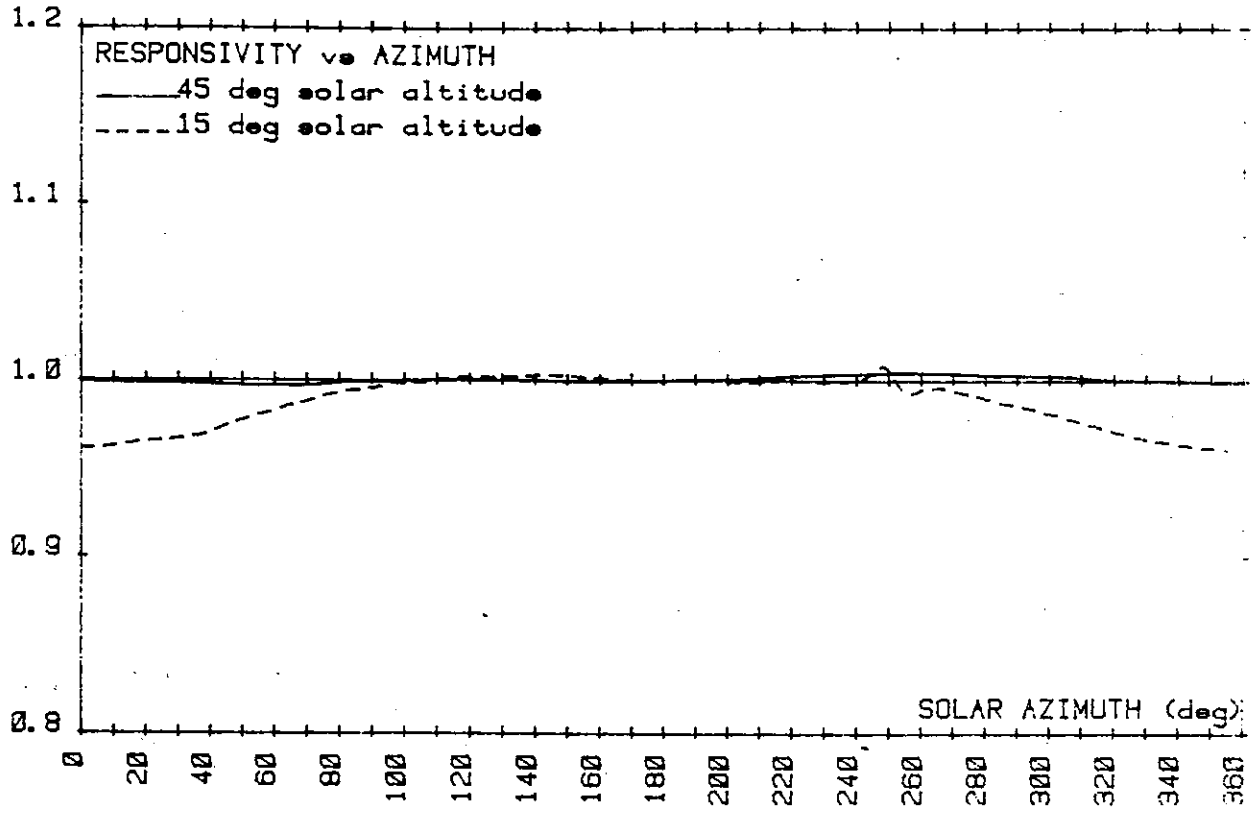

Figure 5 a
RELATIVE RESPONSIVITY VS SOLAR AZIMUTH AND
DEVIATION FROM COS(V)-RESPONSE
Pyranometer: Eppley PSP #15834F3





RELATIVE RESPONSIVITY VS SOLAR AZIMUTH AND
DEVIATION FROM COS(V)-RESPONSE
Pyranometer: Eppley PSP #15835F3





RELATIVE RESPONSIVITY VS SOLAR AZIMUTH AND
DEVIATION FROM COS(V)-RESPONSE

Pyranometer: Kipp&Zonen CM5 #3643

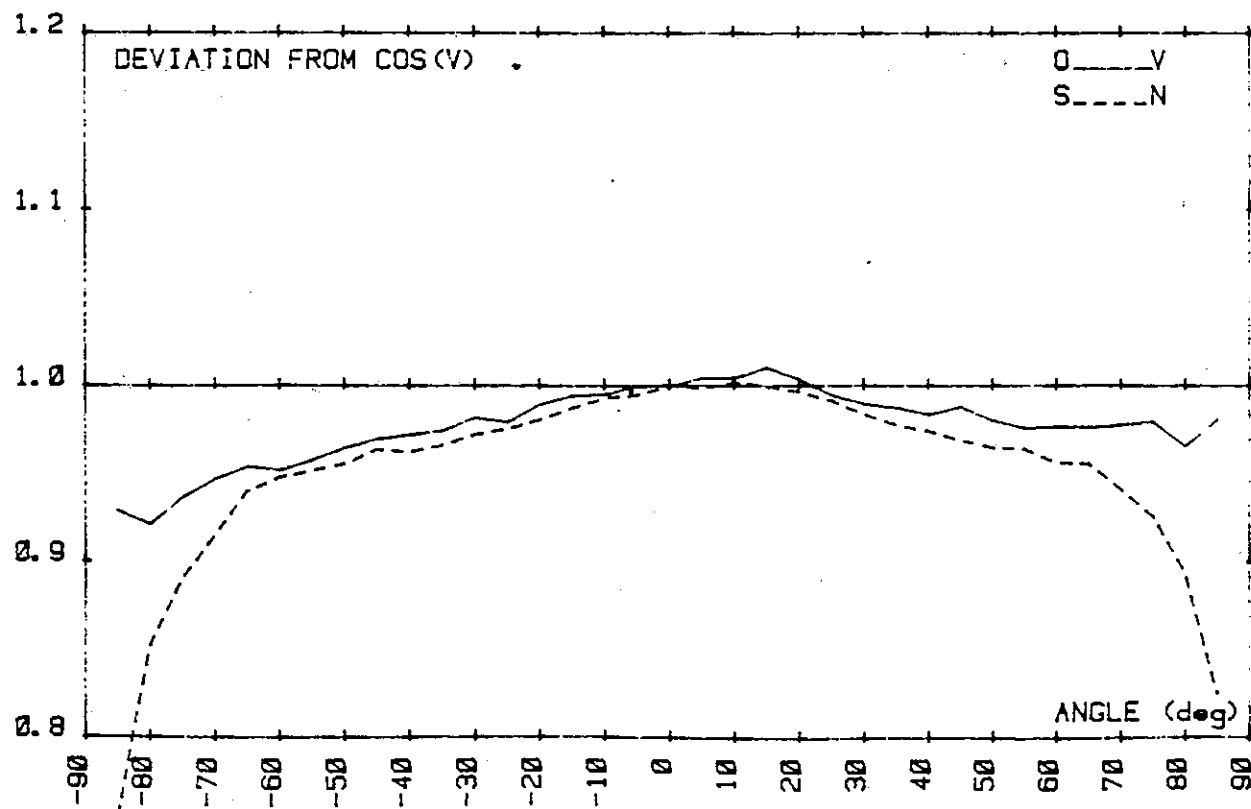
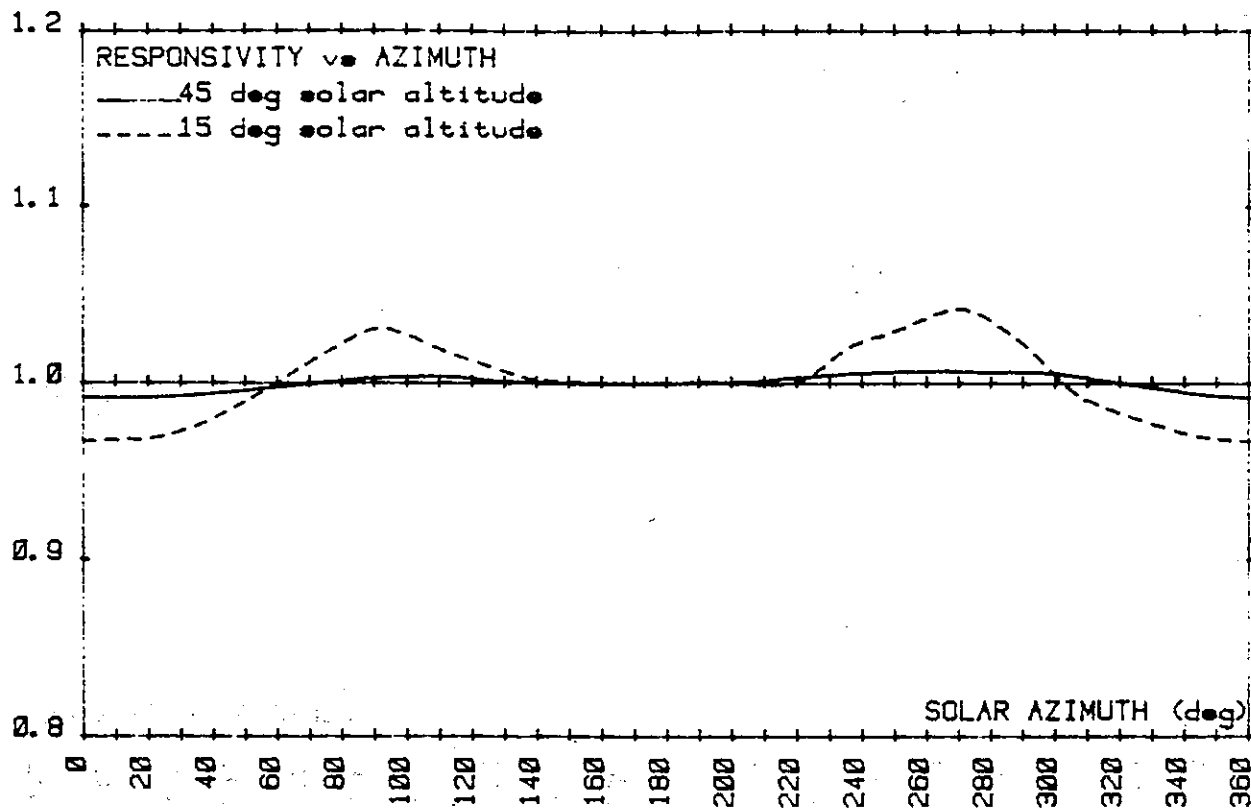



RELATIVE RESPONSIVITY VS SOLAR AZIMUTH AND
DEVIATION FROM COS(V)--RESPONSE

Pyranometer: Kipp&Zonen CM5 #3644

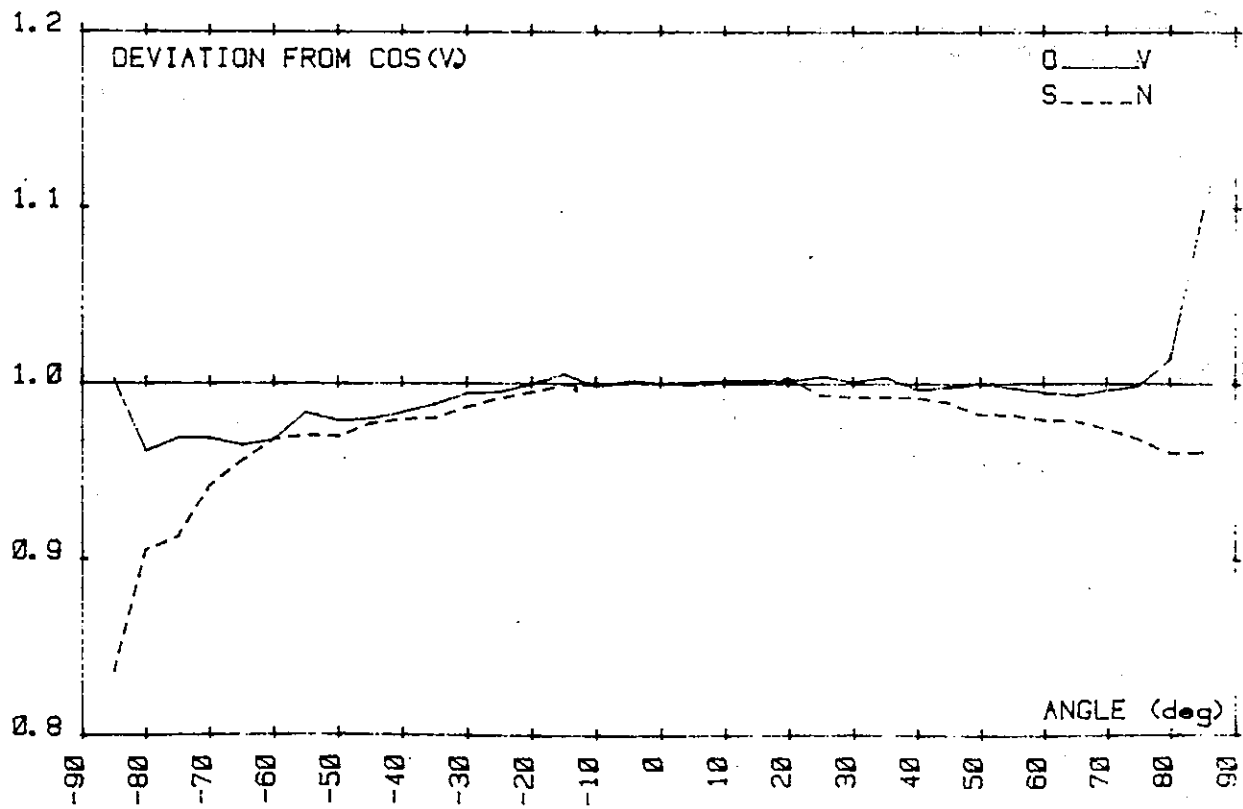
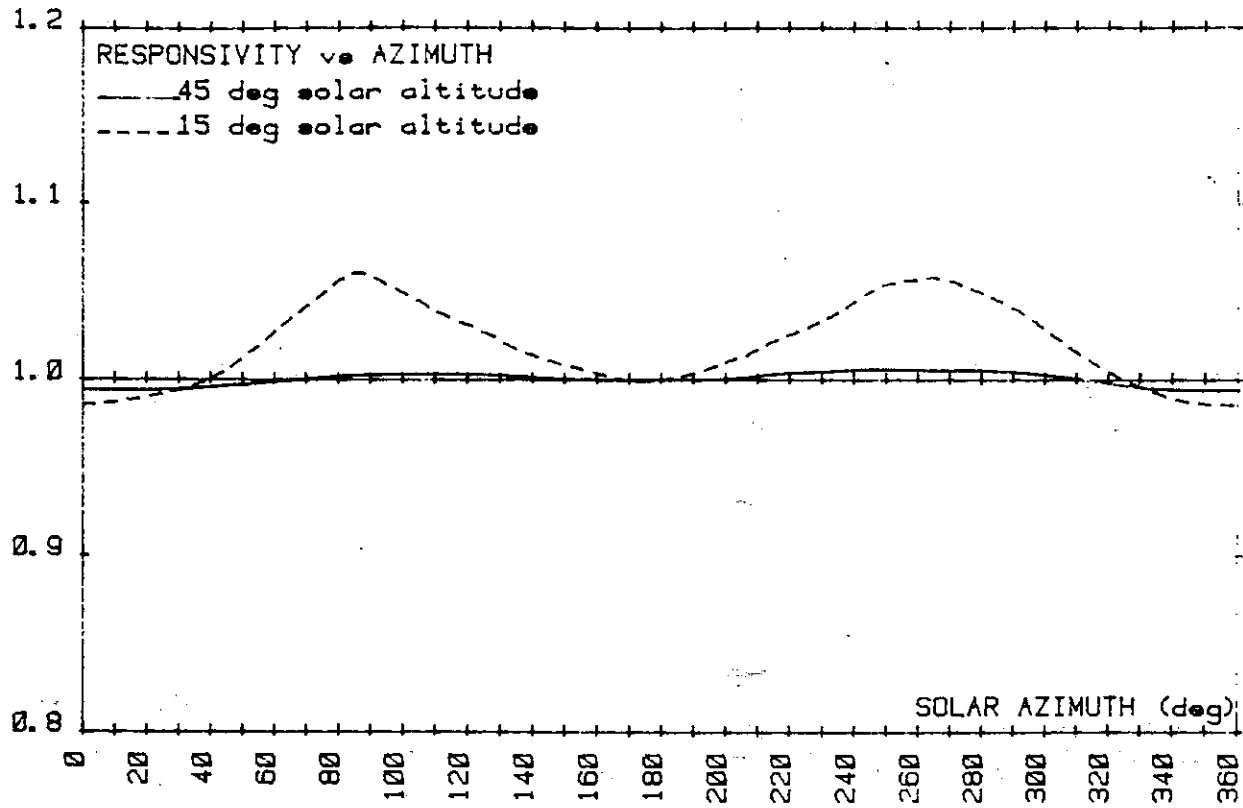



RELATIVE RESPONSIVITY VS SOLAR AZIMUTH AND DEVIATION FROM COS(V)-RESPONSE

Pyranometers: Schenk Star 8101 #2046

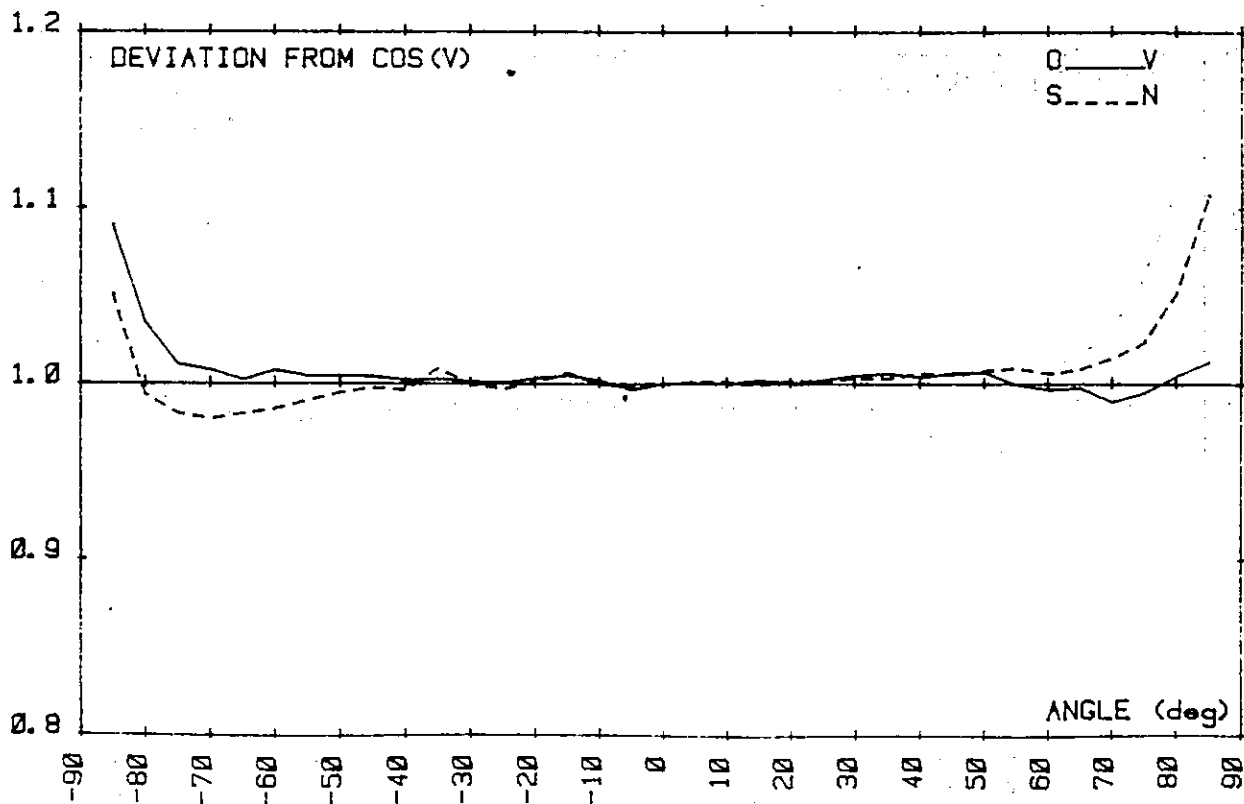
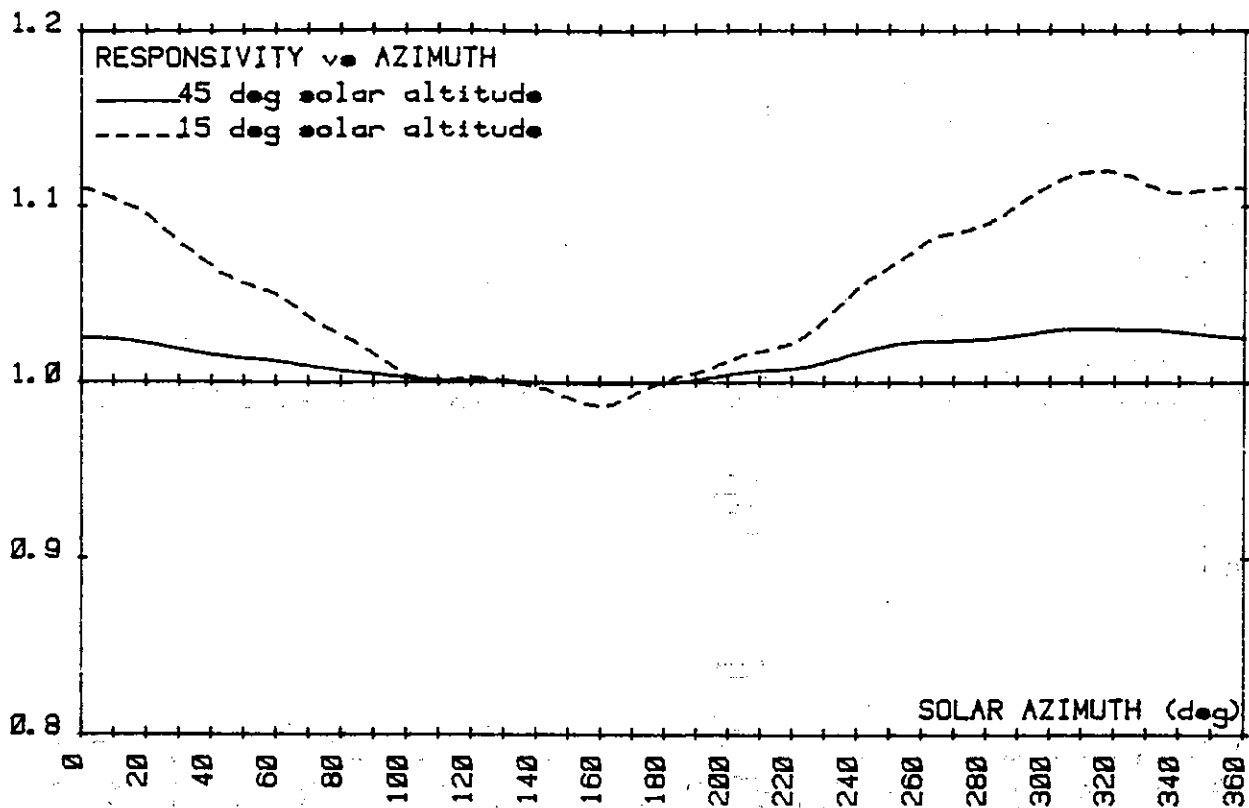



Figure 5 f

RELATIVE RESPONSIVITY VS SOLAR AZIMUTH AND
DEVIATION FROM COS(V)-RESPONSE

Pyranometers: Sohank Star 8101 #2057

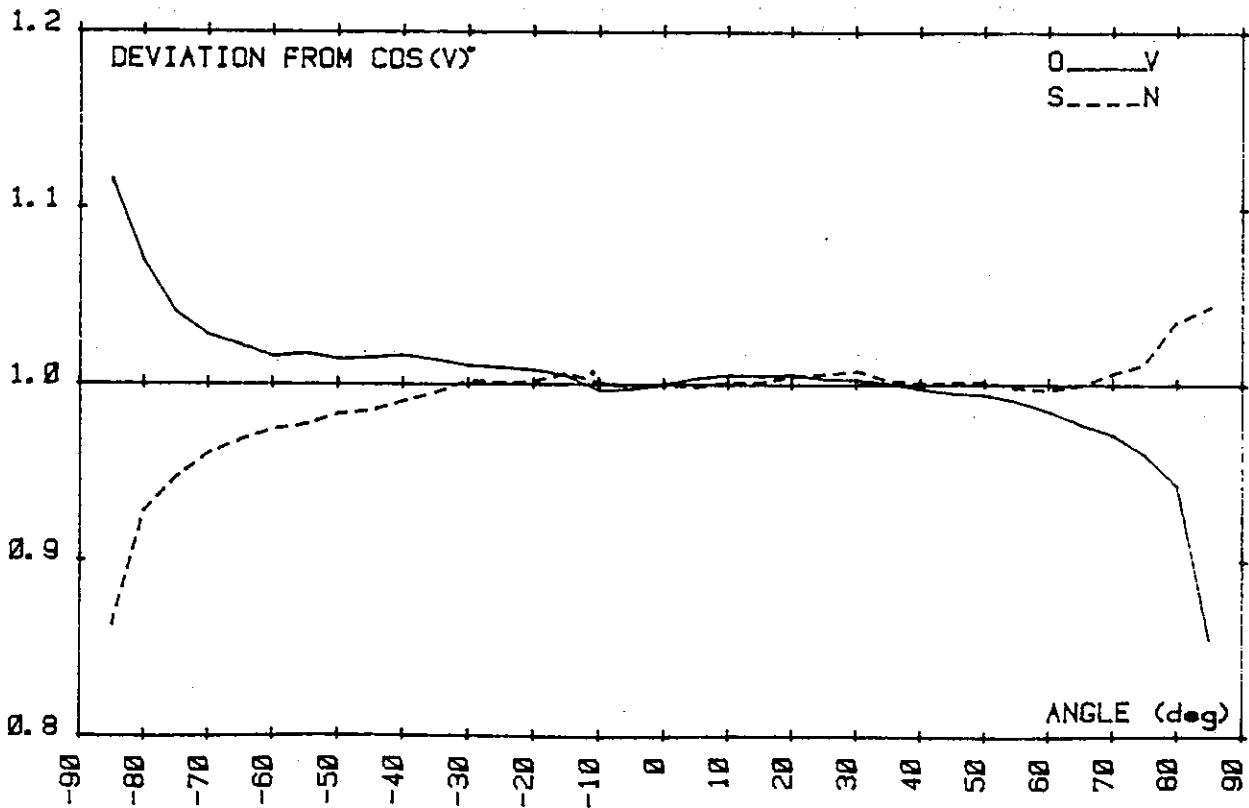
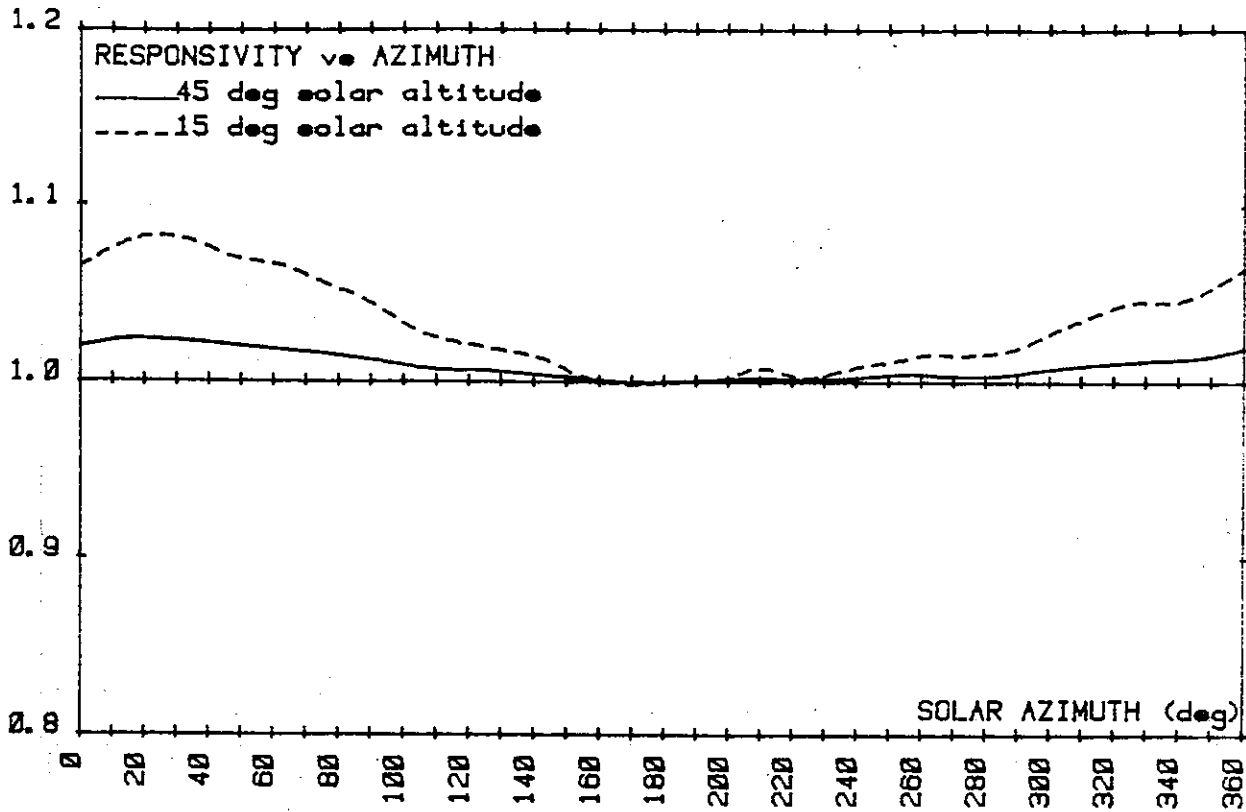
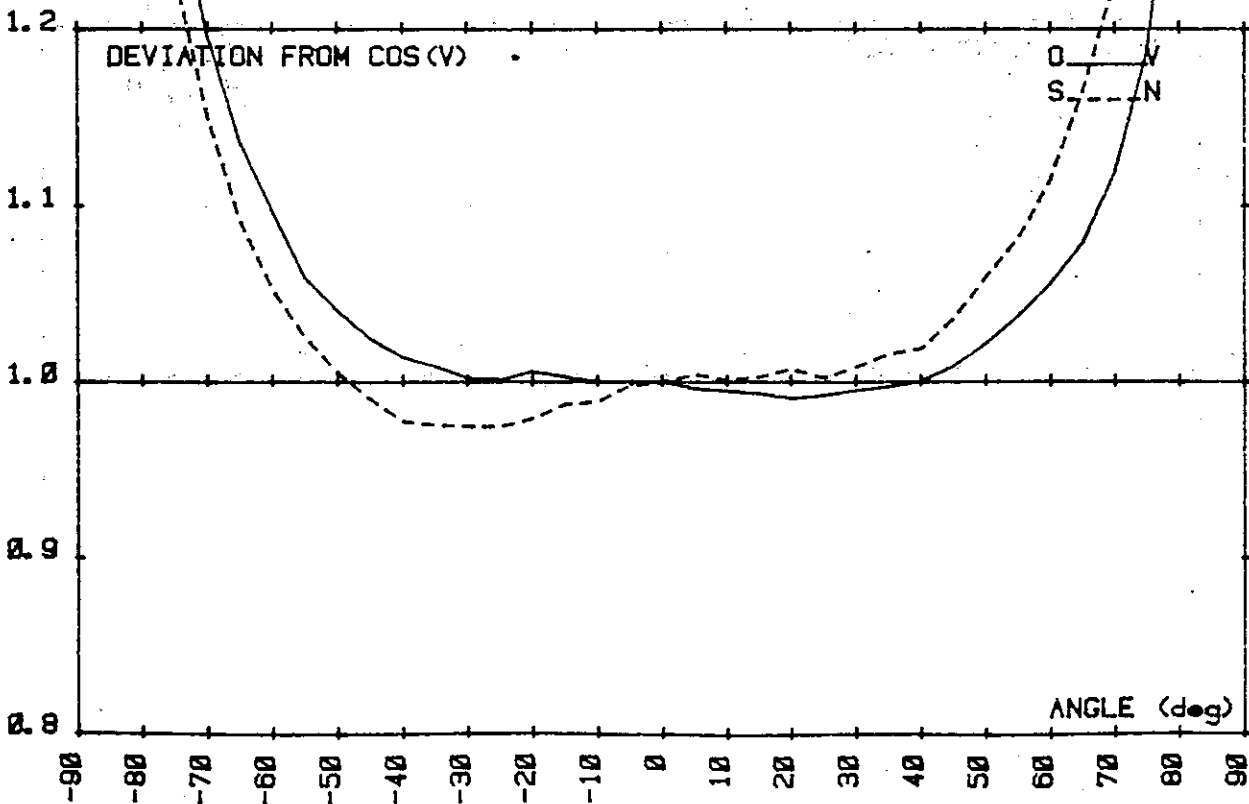
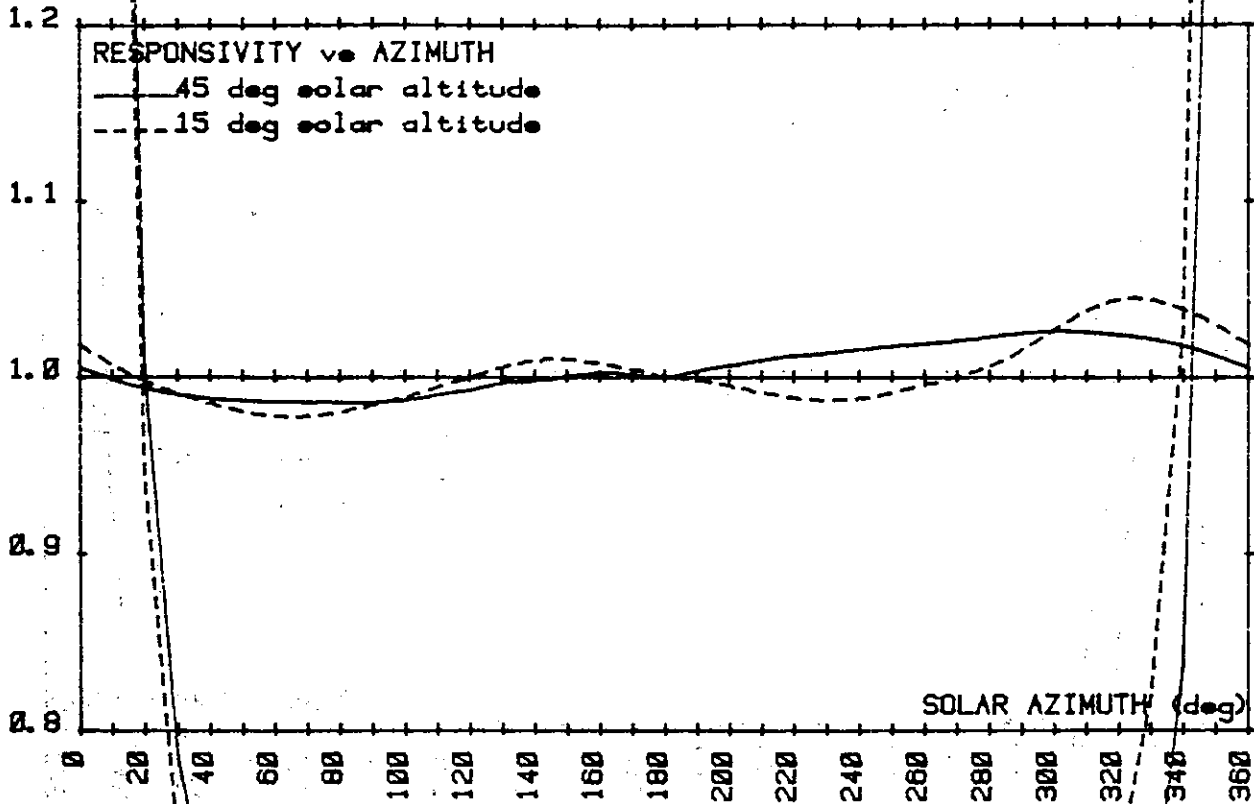

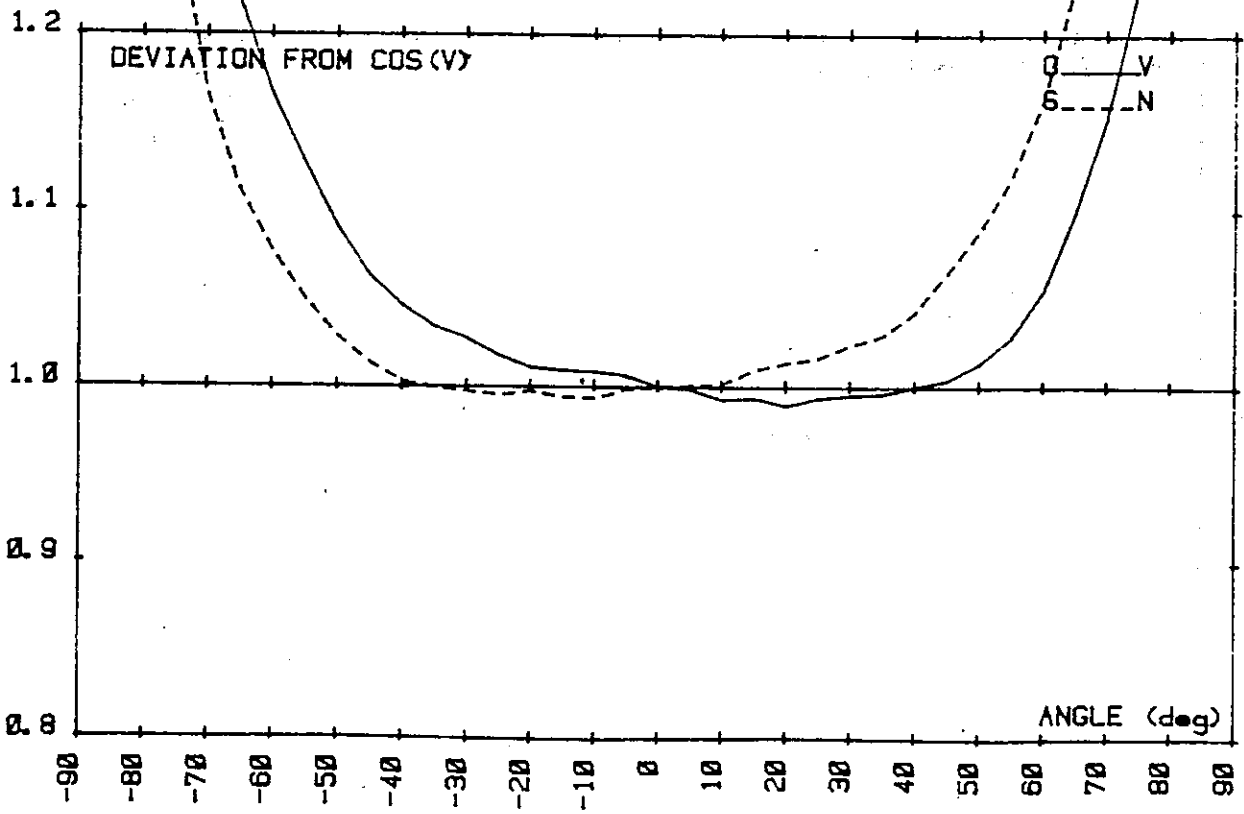
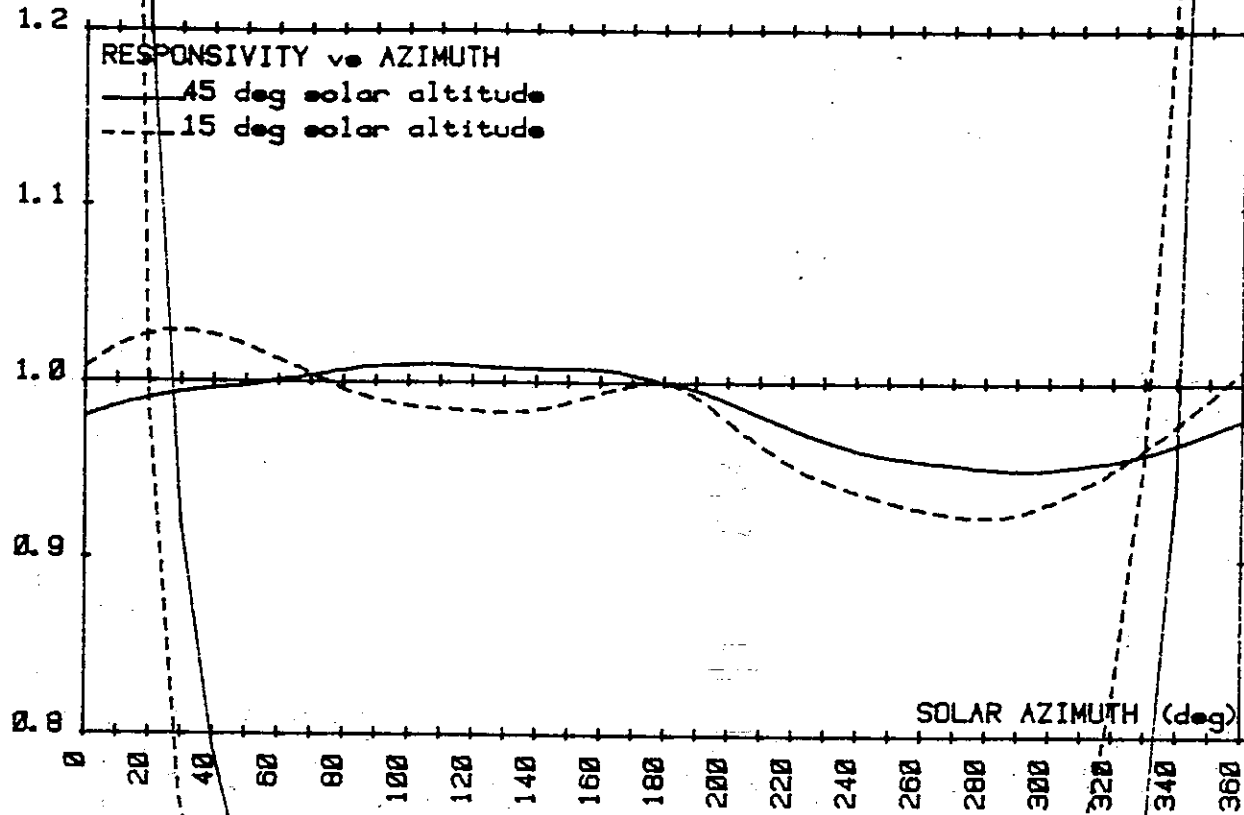

Figure 5 g
RELATIVE RESPONSIVITY VS SOLAR AZIMUTH AND
DEVIATION FROM COS(V)-RESPONSE
Pyranometer: Lintronic Dome 615 #1222





RELATIVE RESPONSIVITY VS SOLAR AZIMUTH AND
DEVIATION FROM COS(V)-RESPONSE
Pyranometers: Lintronic Dome 615 #1993





RELATIVE RESPONSIVITY VS SOLAR AZIMUTH AND
DEVIATION FROM COS(V)-RESPONSE
Pyranometer: LI-COR LI-200S #2360

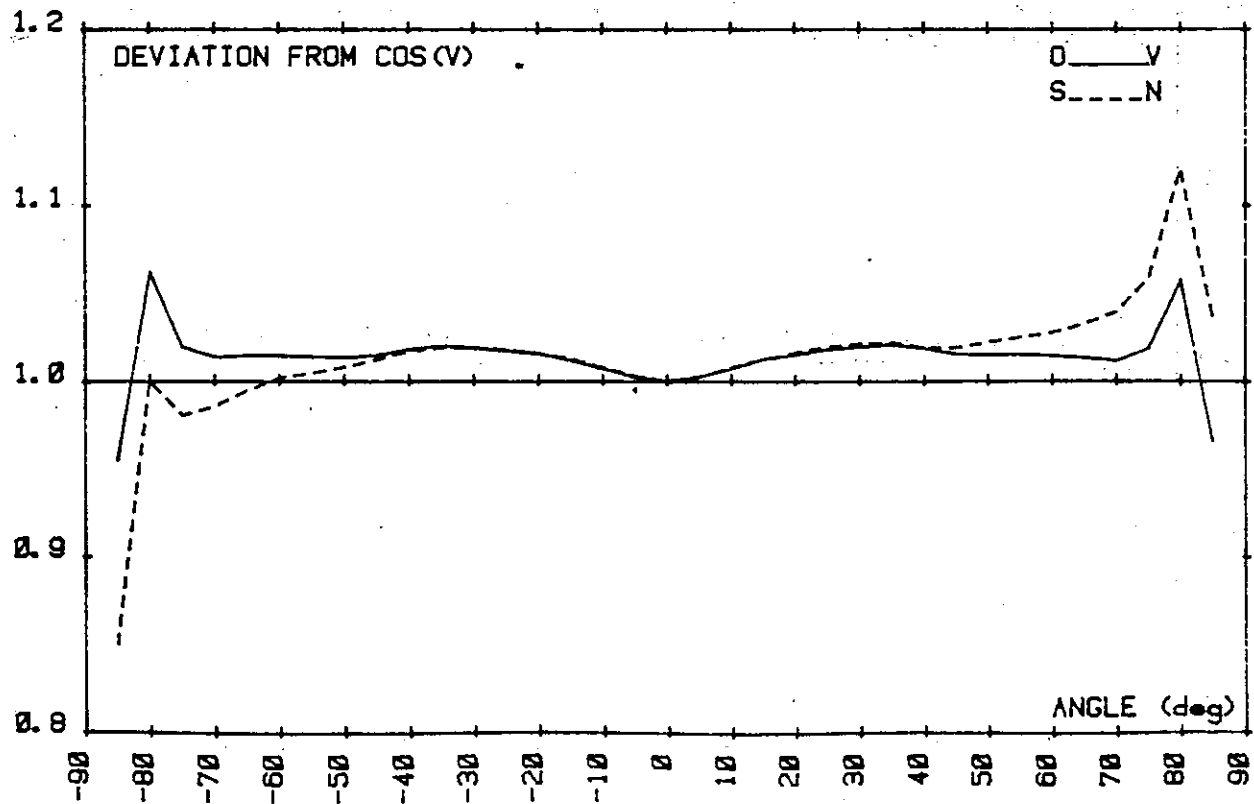
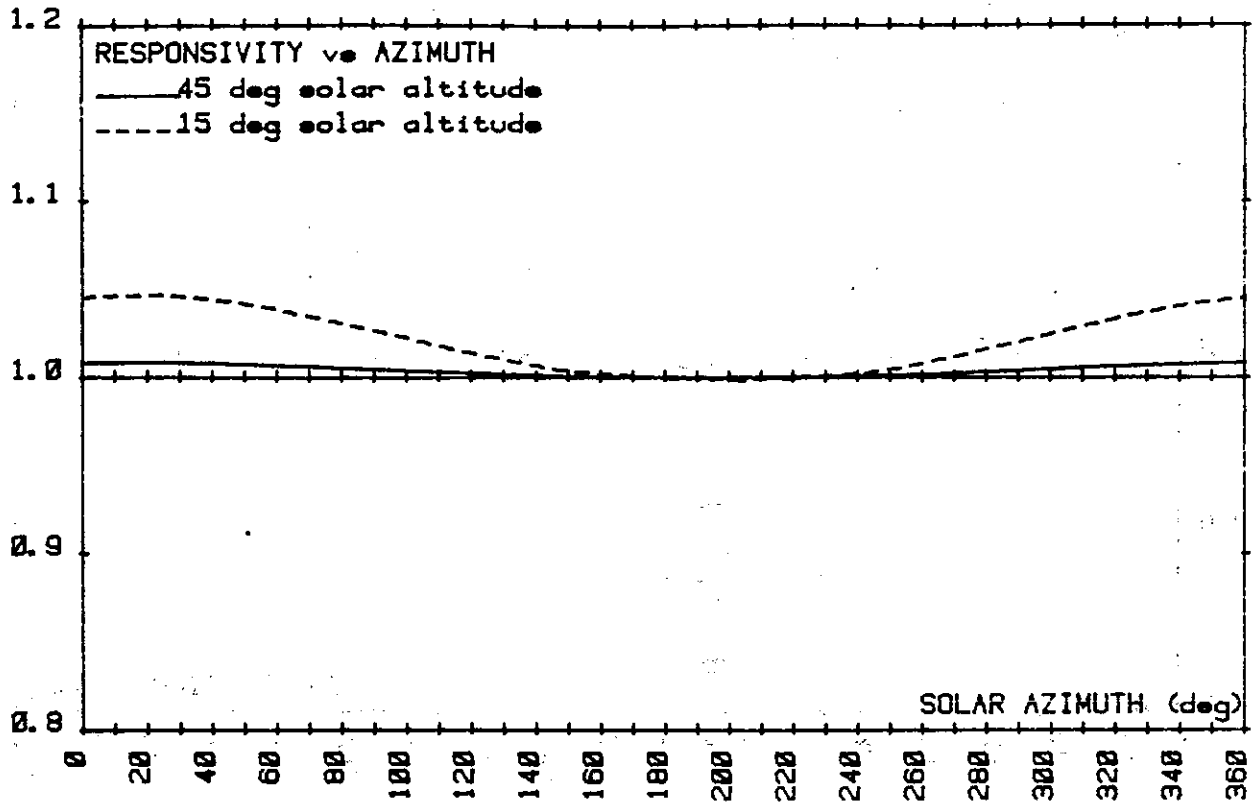



RELATIVE RESPONSIVITY VS SOLAR AZIMUTH AND DEVIATION FROM COS(V)-RESPONSE

Pyranometers: LI-COR LI-200S #2361

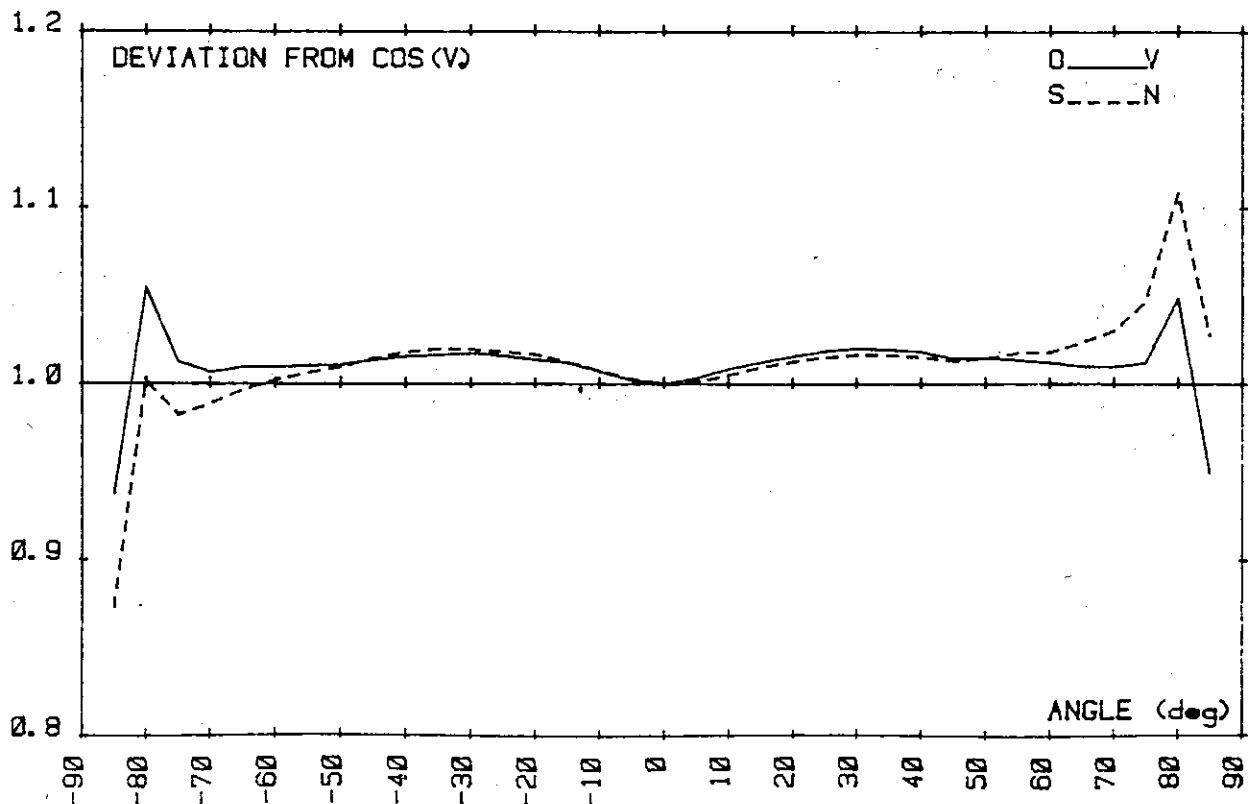
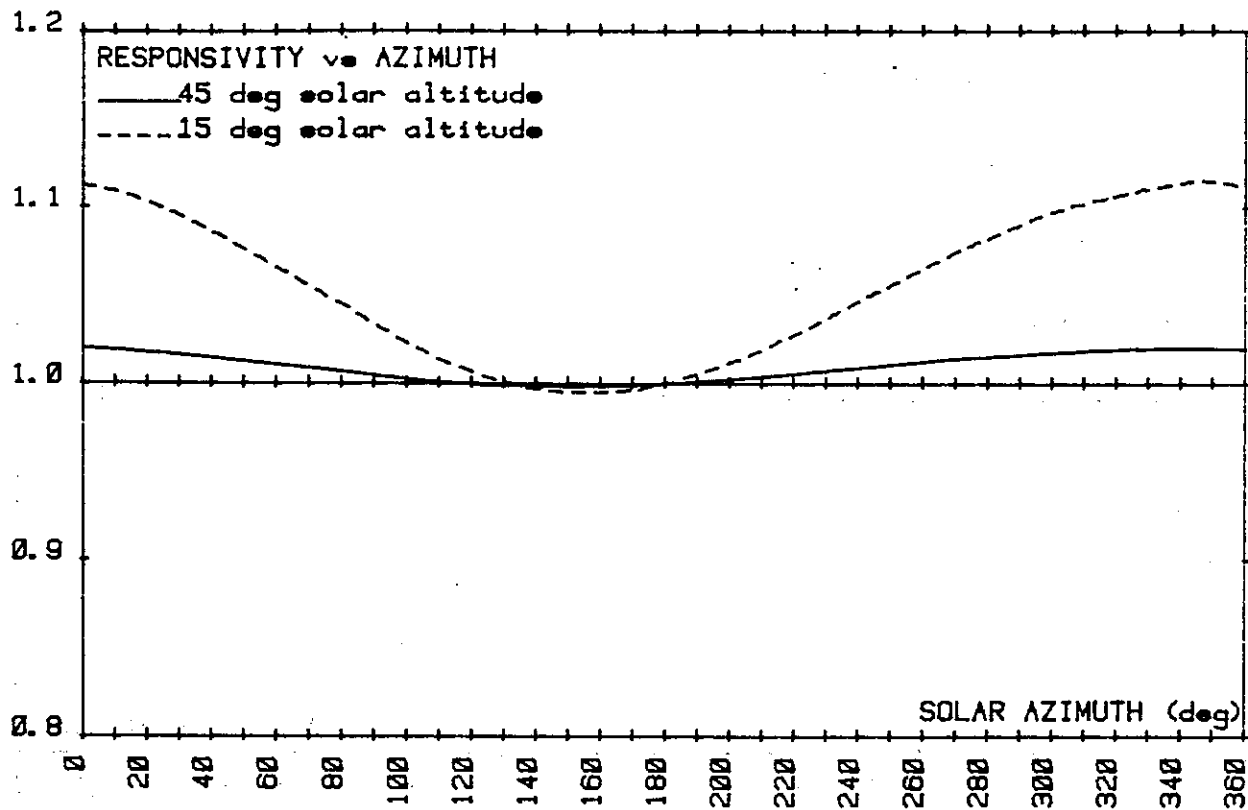



RELATIVE RESPONSIVITY VS SOLAR AZIMUTH AND
DEVIATION FROM COS(V)-RESPONSE
Pyranometers: Hollie MR-5 #1996

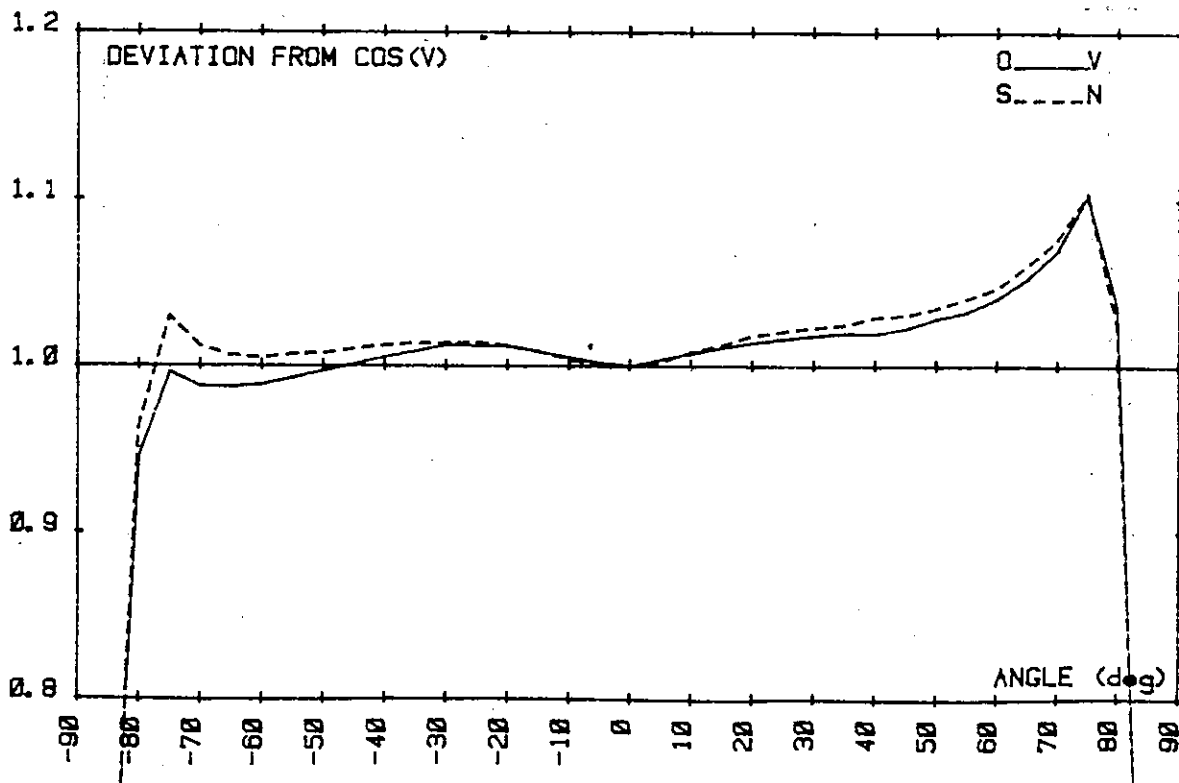
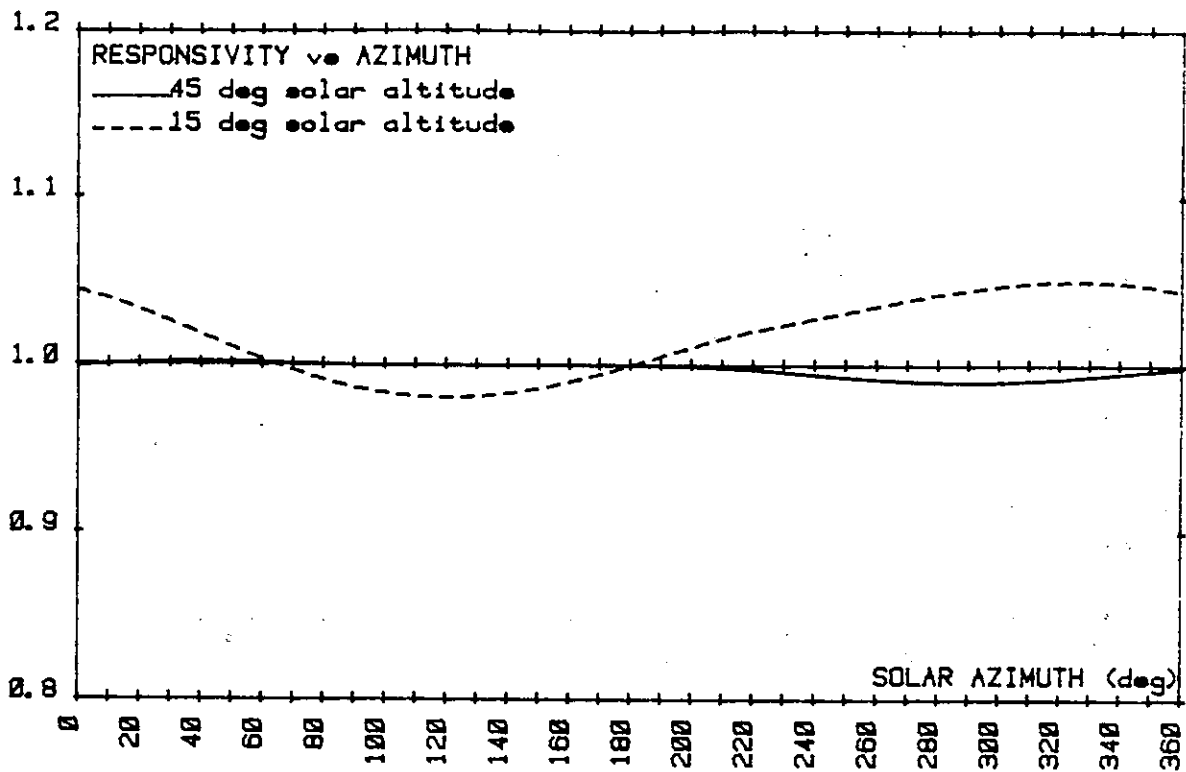

Relative spectral responsivity for Li-Cor 200S

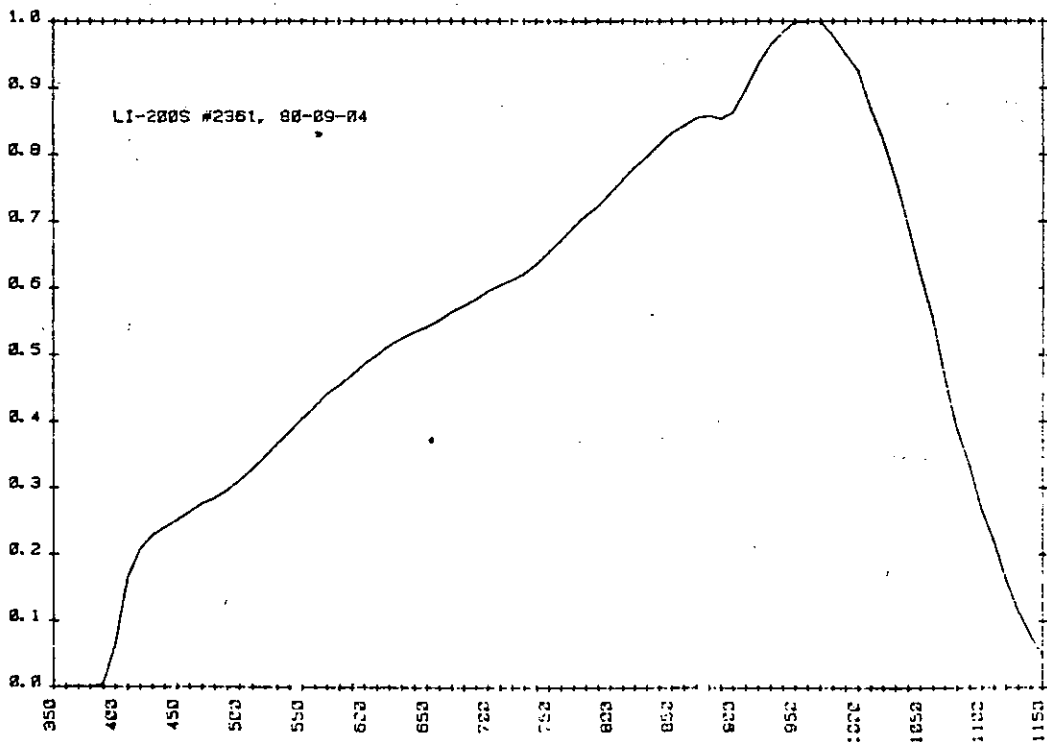
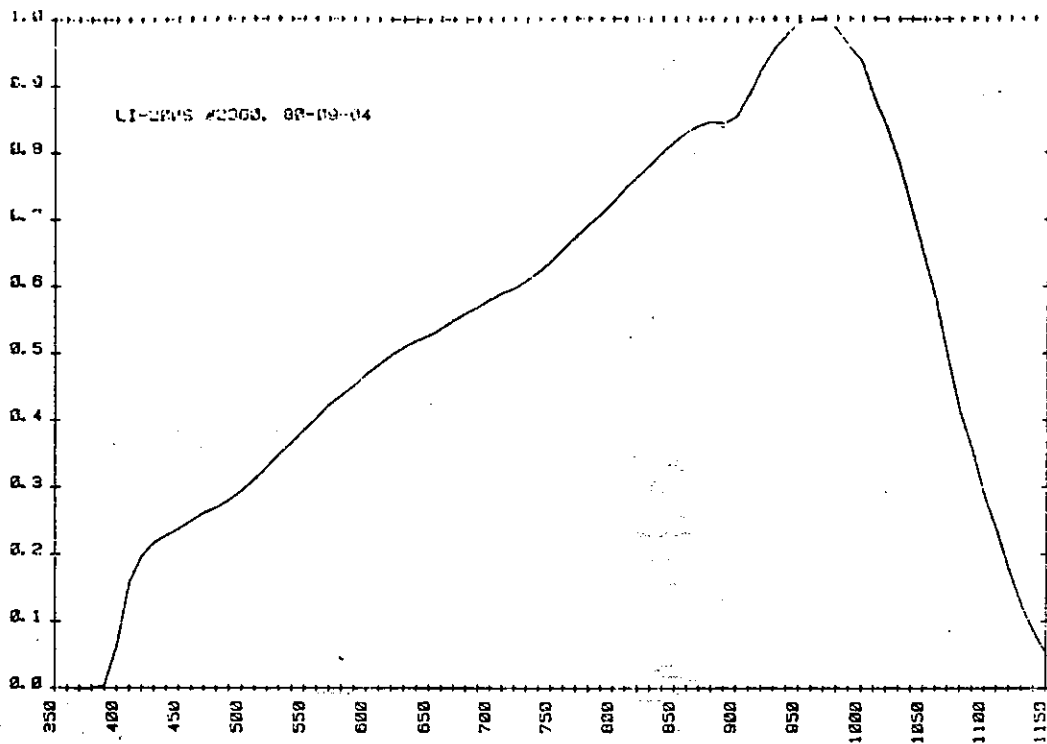

Figure 6 c

Relative spectral responsivity for Hollis MR5

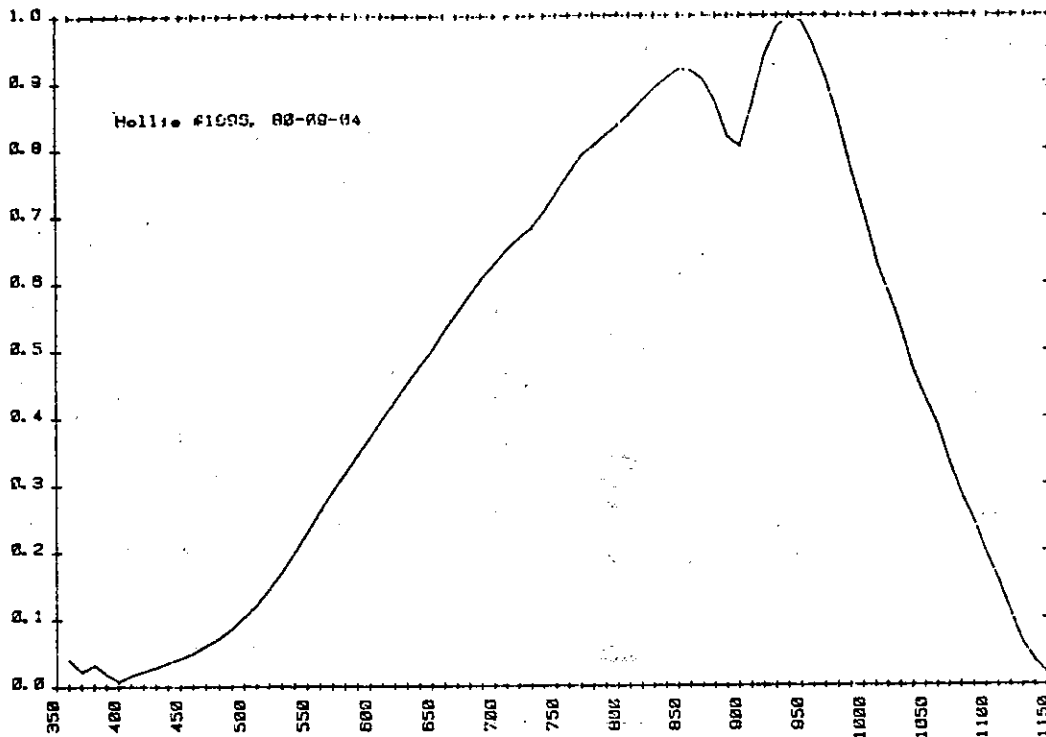

Figure 7

Spectral power distribution, dependence on air mass (Ref 4)

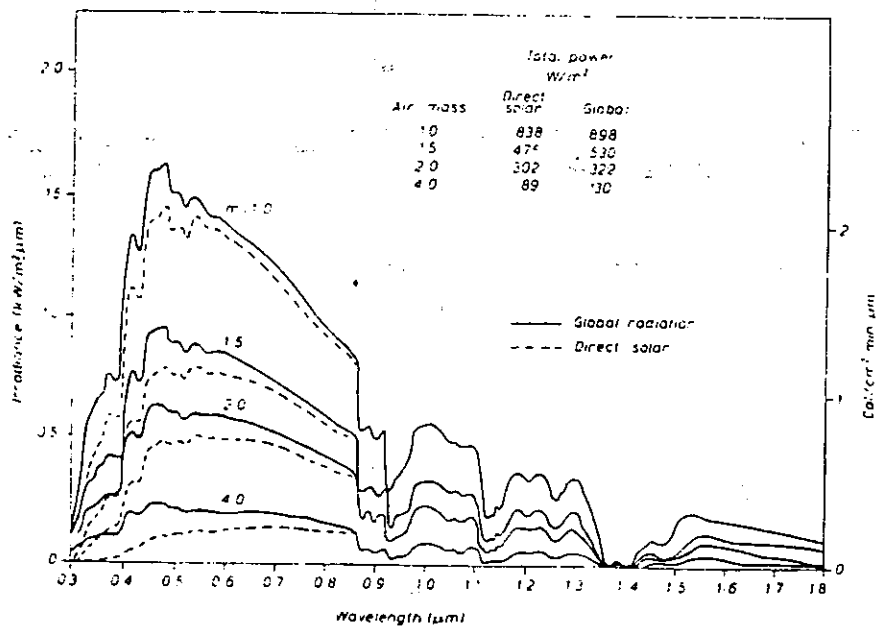

FIG. 66. Spectral power distribution of direct solar and global radiation incident on horizontal surface at sea level: dependence on air mass. Earth albedo zero, other conditions as Fig 65 except H₂O



Figure 3 a

SOLAR IRRADIANCE RELATIVE EPPLEY PSP #15834F3 (8.75 mV/kW/m²)
Pyranometers Eppley PSP #14626F3 with responsivity 9.78 mV/kW/m²
Horizontally mounted
Borås, Sweden 13-21 September 1980

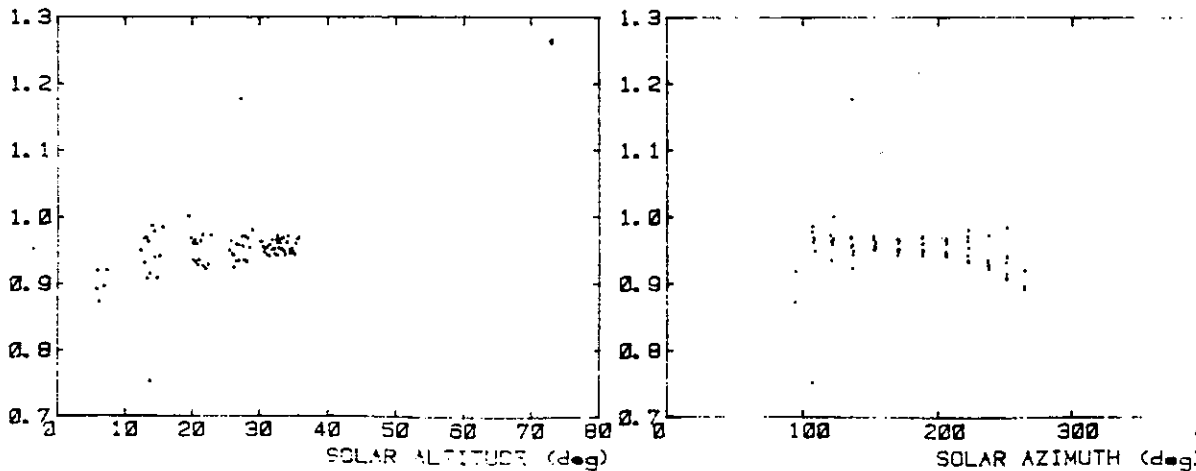
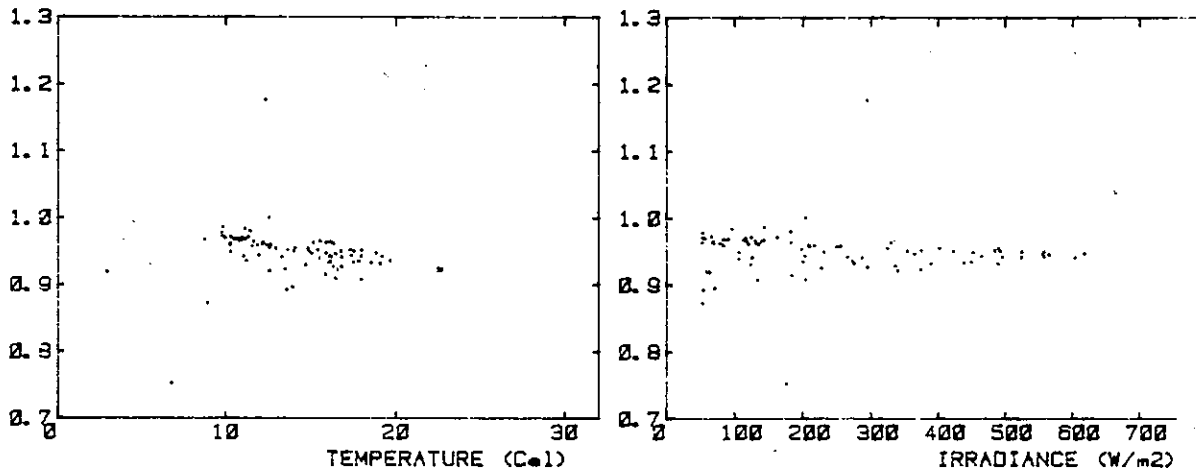
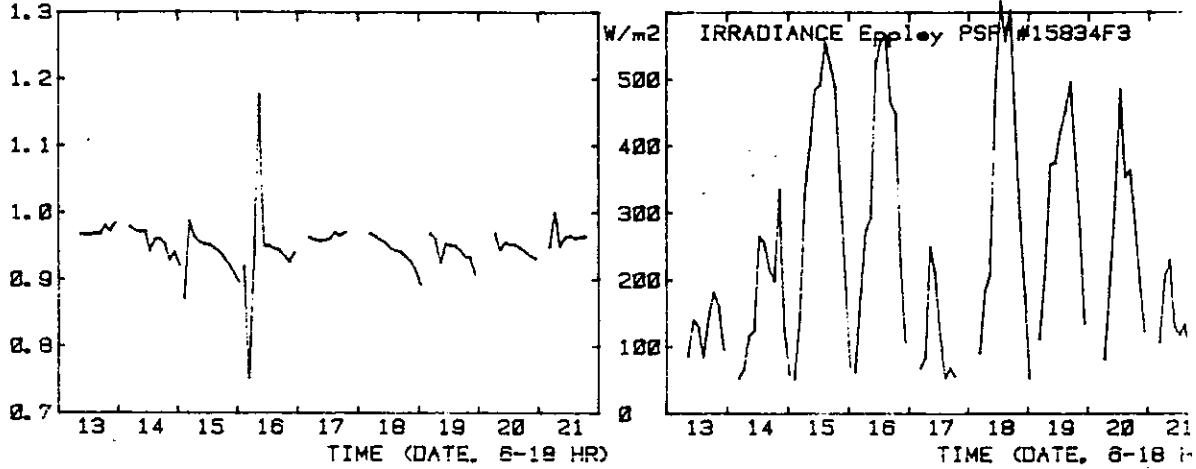



Figure 3 b

SOLAR IRRADIANCE RELATIVE EPPLEY PSP #15834F3 (8.75 mV/kW/m²)

Pyranometers: Kipp&Zonen CM5 #3643 with responsivity: 12.6 mV/kW/m²

Horizontally mounted

Barås, Sweden 13-21 September 1988

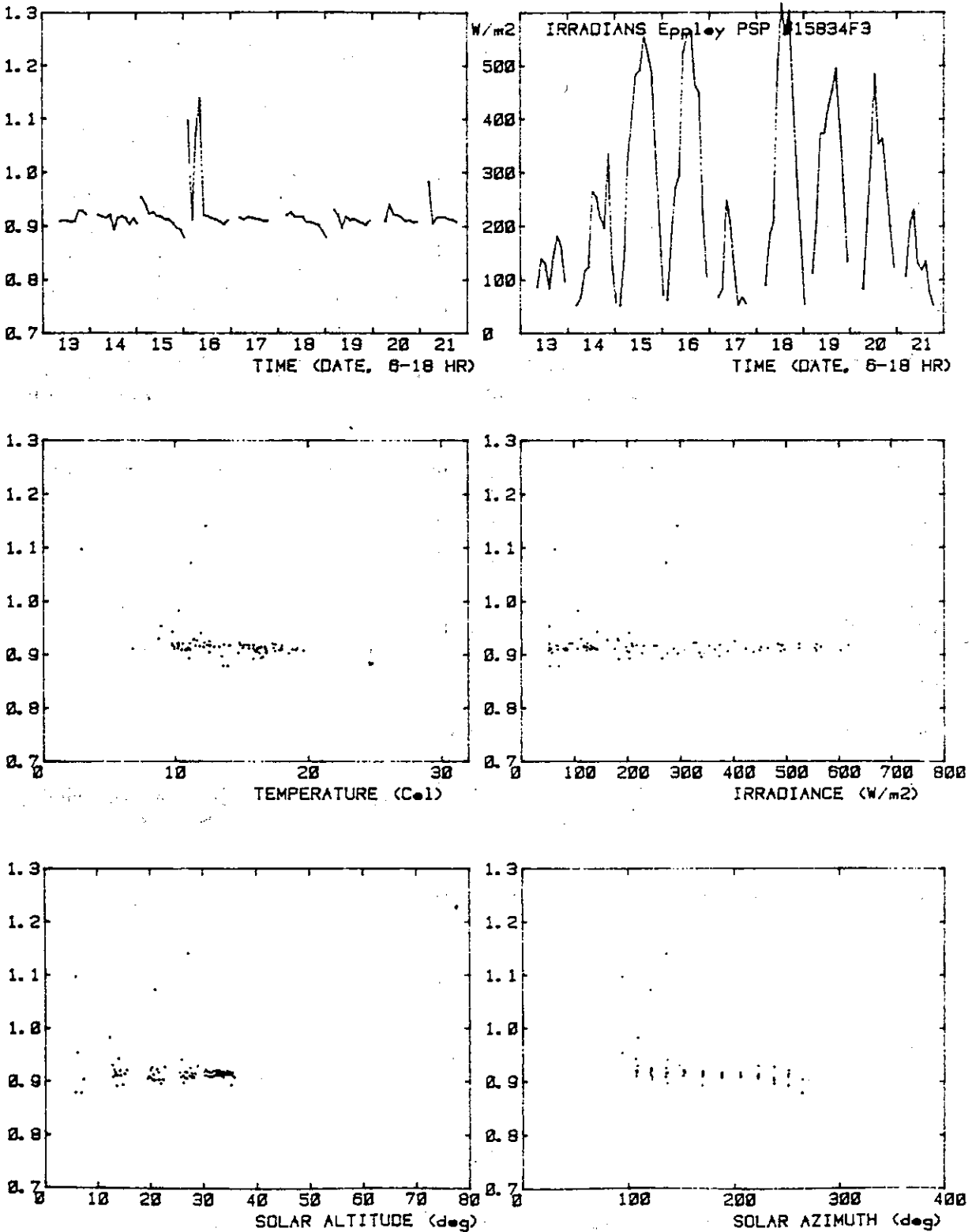



Figure 3 c

SOLAR IRRADIANCE RELATIVE EPPLEY PSP #15834F3 (8.75 mV/kW/m2)

Pyranometers Kipp&Zonen CM5 #3644 with responsivity: 12.3 mV/kW/m2

Horizontally mounted

Borås, Sweden 13-21 September 1988

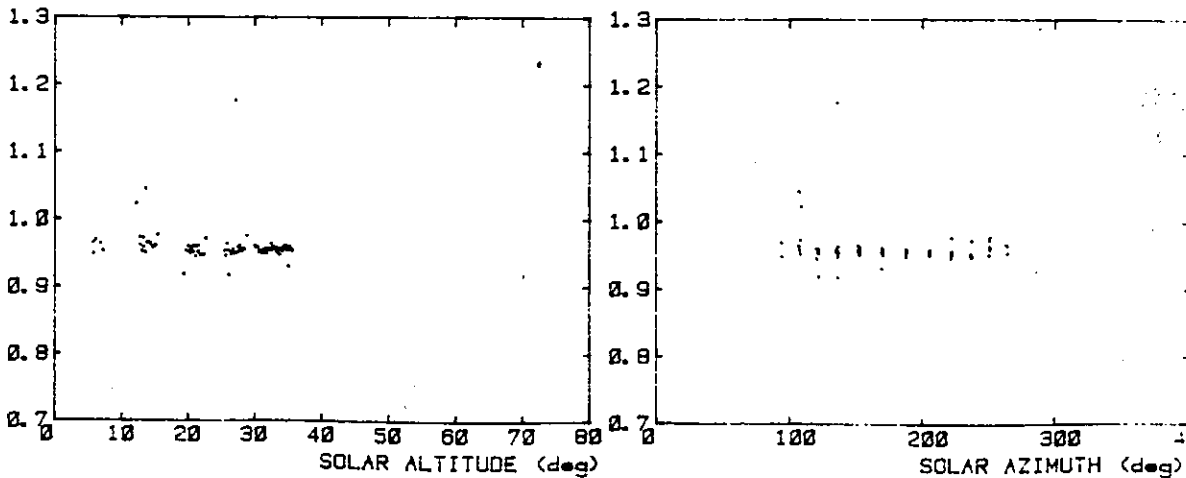
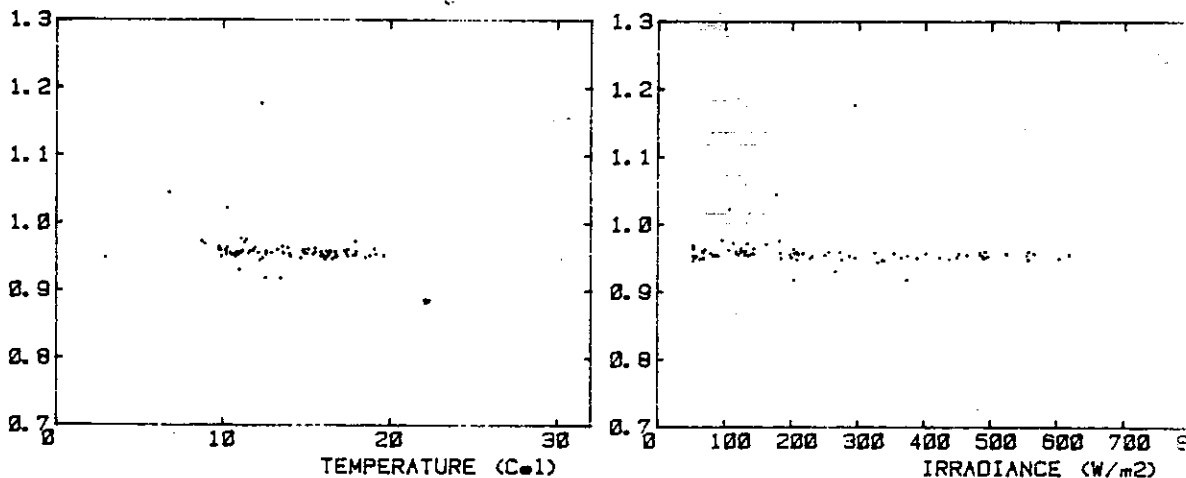
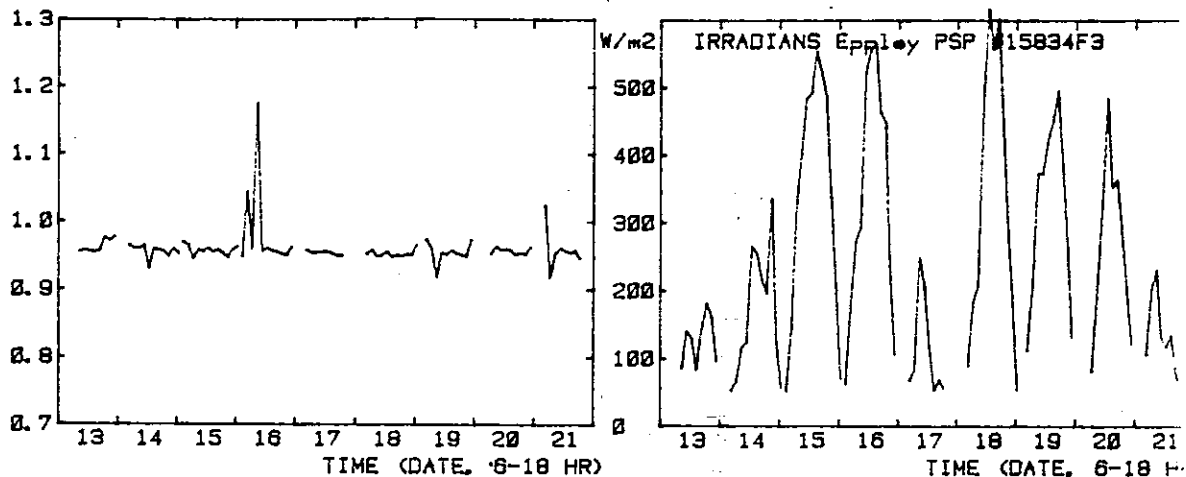



Figure 3 d

SOLAR IRRADIANCE RELATIVE EPPLLEY PSP #15834F3 (8.75 mV/kW/m2)

Pyranometers: Schenk Star 8101 #2848 with responsivity: 15.76 mV/kW/m2

Horizontally mounted

Borås, Sweden 13-21 September 1988

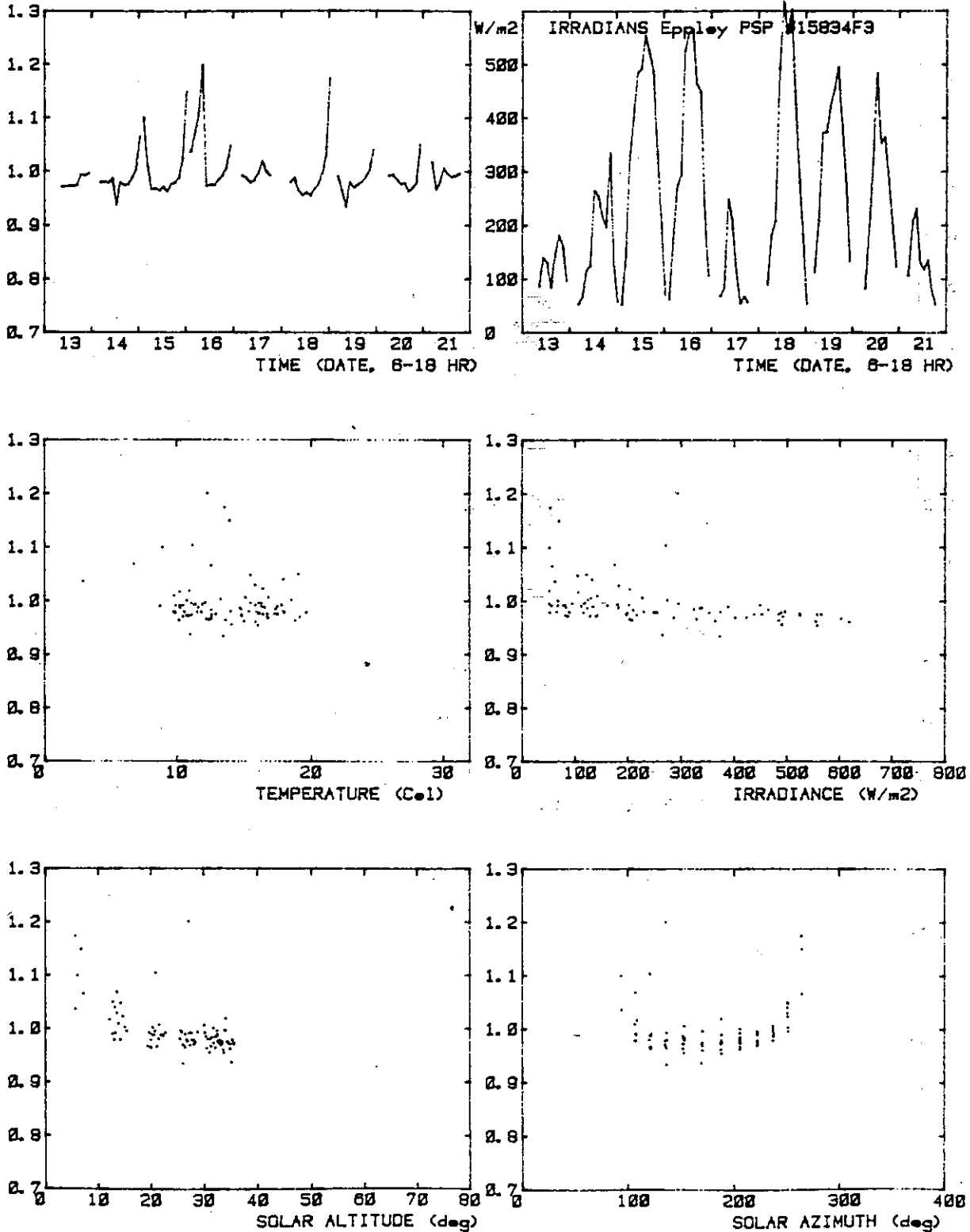



Figure 3 e

SOLAR IRRADIANCE RELATIVE EPPLEY PSP #15834F3 (8.75 mV/kW/m2)

Pyranometer: Schenk Star 8101 #2057 with responsivity: 15.76 mV/kW/m2

Horizontally mounted

Borås, Sweden 13-21 September 1980

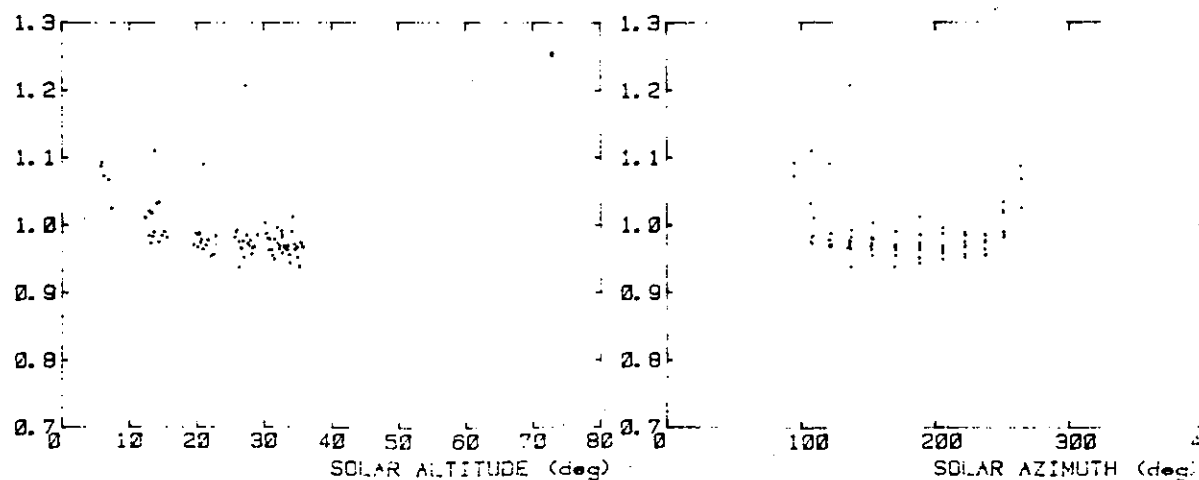
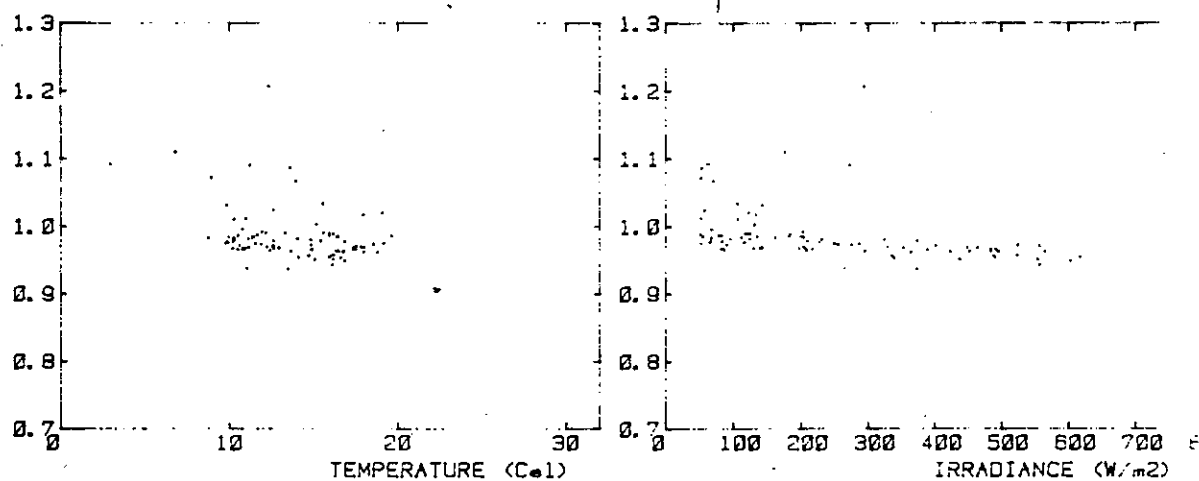
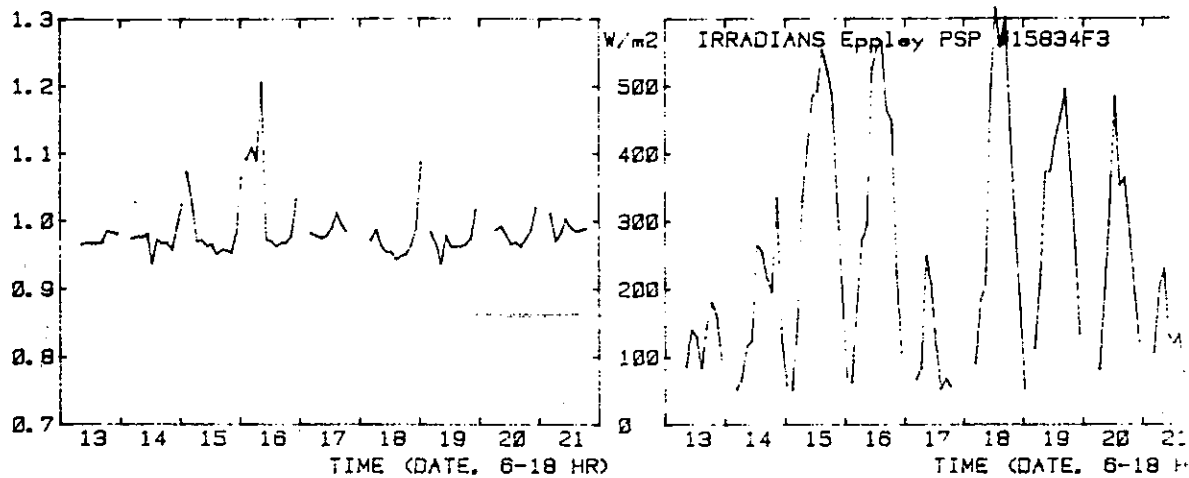



Figure 6 f

SOLAR IRRADIANCE RELATIVE EPPLEY PSP #15834F3 (8.75 $\mu\text{V}/\text{kW}/\text{m}^2$)

Pyranometers: Lintronics Dome 615 #1222 with responsivity: 11.67 $\mu\text{V}/\text{kW}/\text{m}^2$

Horizontally mounted

Borås, Sweden 13-21 September 1988

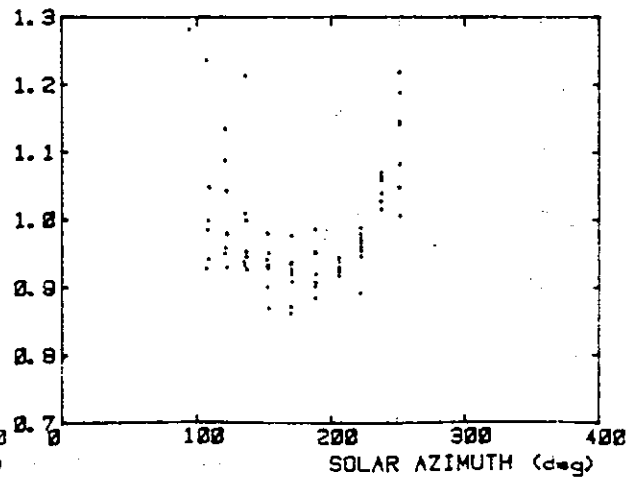
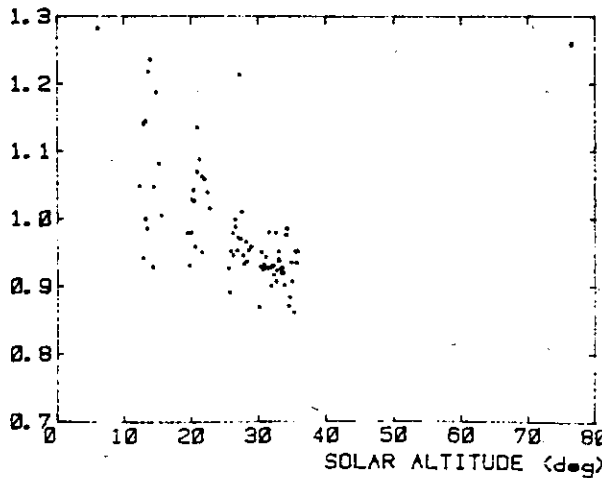
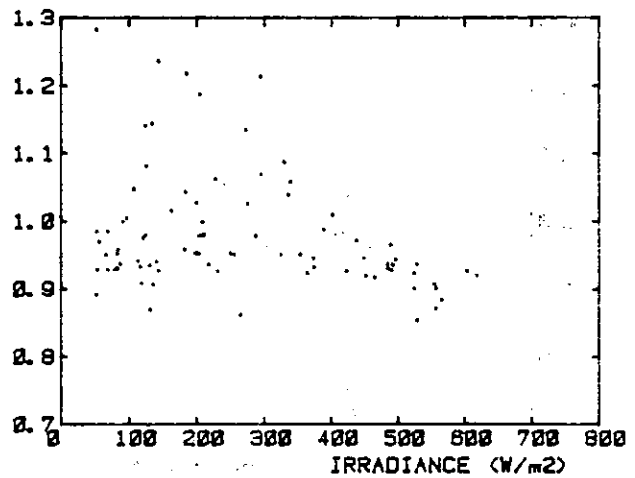
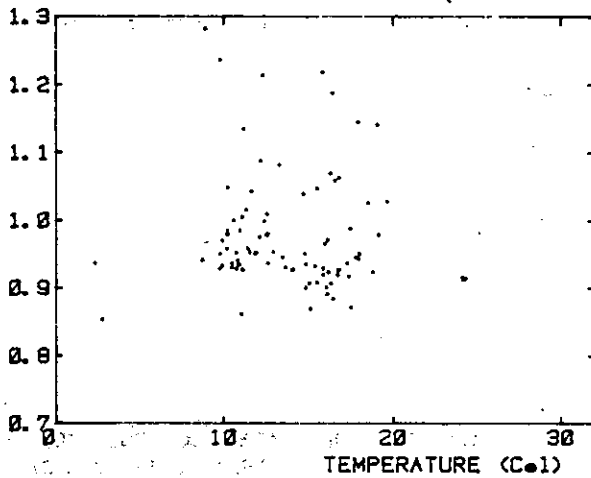
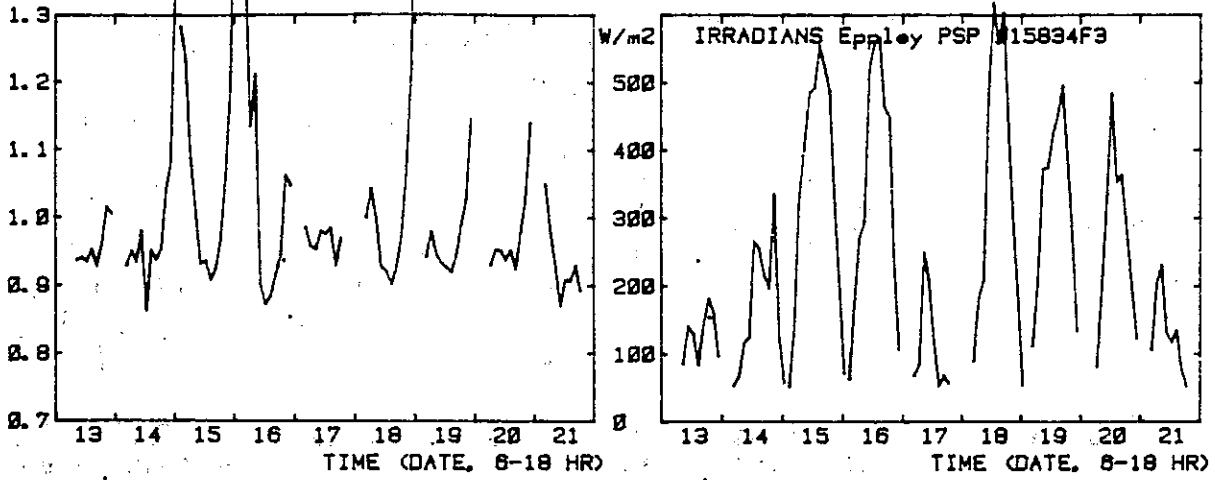



Figure 8 g

SOLAR IRRADIANCE RELATIVE EPPLEY PSP #15834F3 (8.75 mV/kW/m²)

Pyranometers: Lintronic Dome 615 #1993 with responsivity 10.98 mV/kW/m²

Horizontally mounted

Borås, Sweden 13-21 September 1980

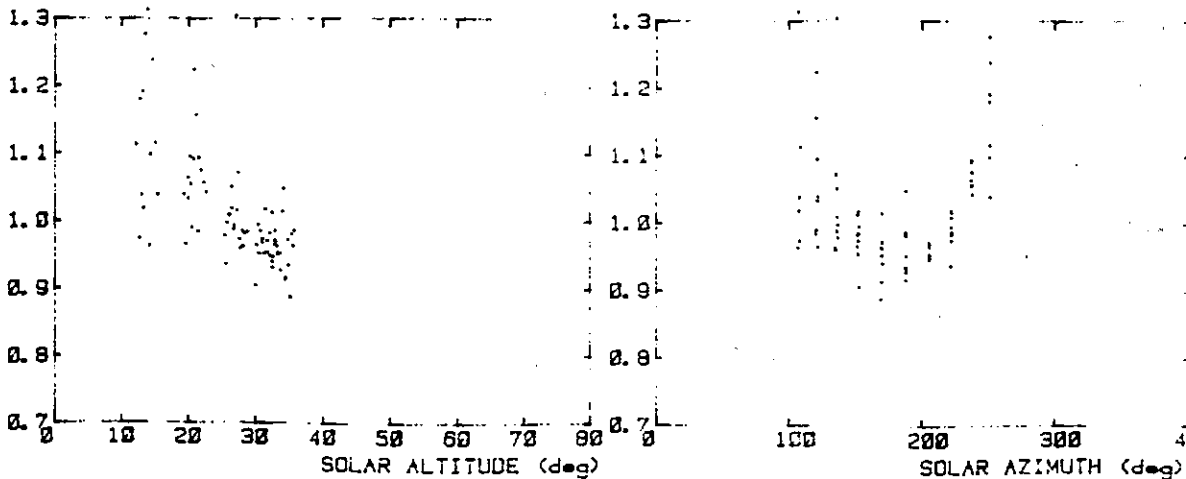
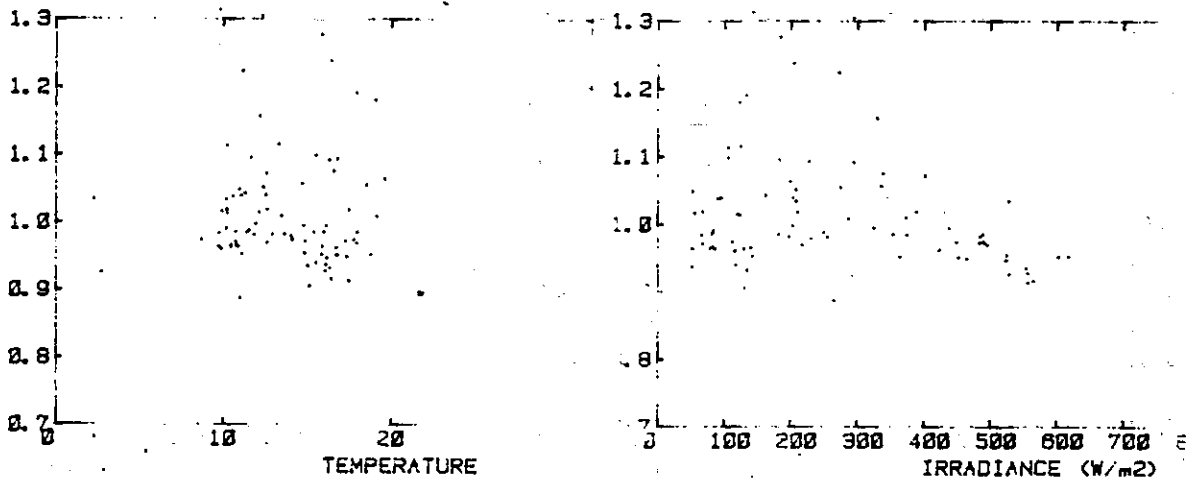
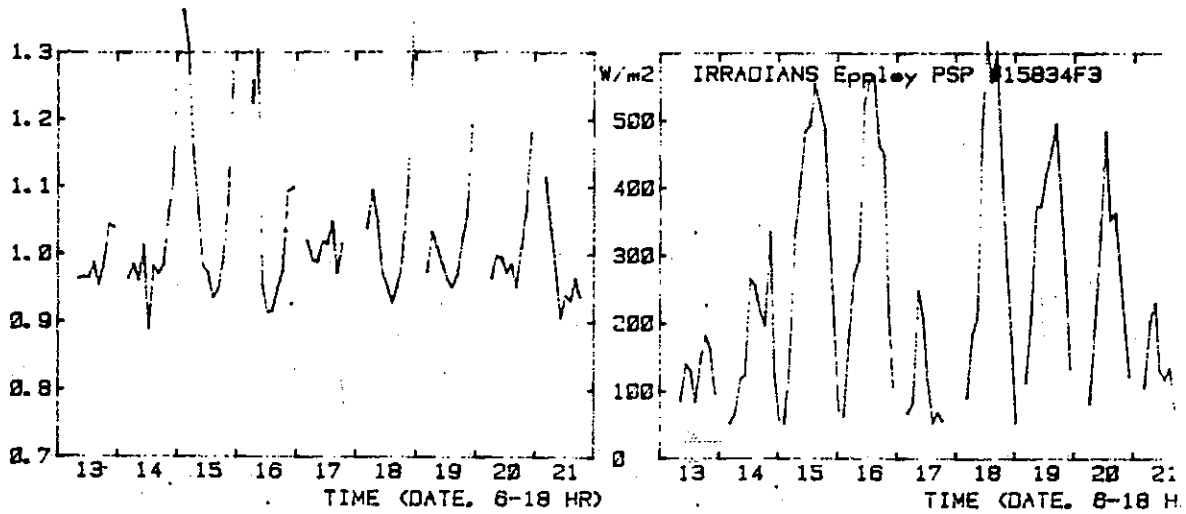



Figure 8 h

SOLAR IRRADIANCE RELATIVE EPPLEY PSP #15834F3 (8.75 mV/kW.m²)

Pyranometers LI-COR LI-200S #2368 with responsivity: 8.0 mV/kW/m²

Horizontally mounted

Borås, Sweden 13-21 September 1988

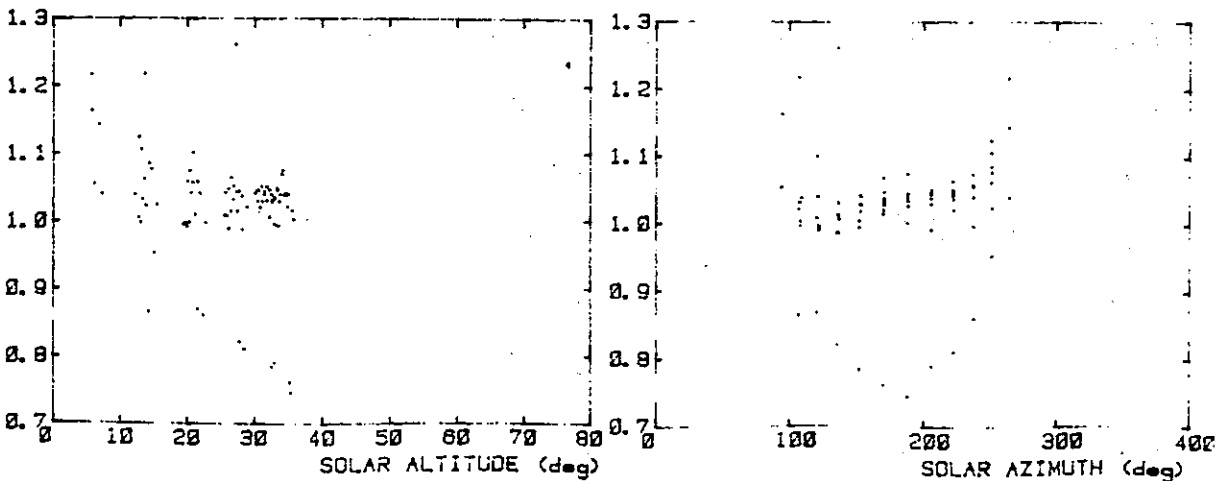
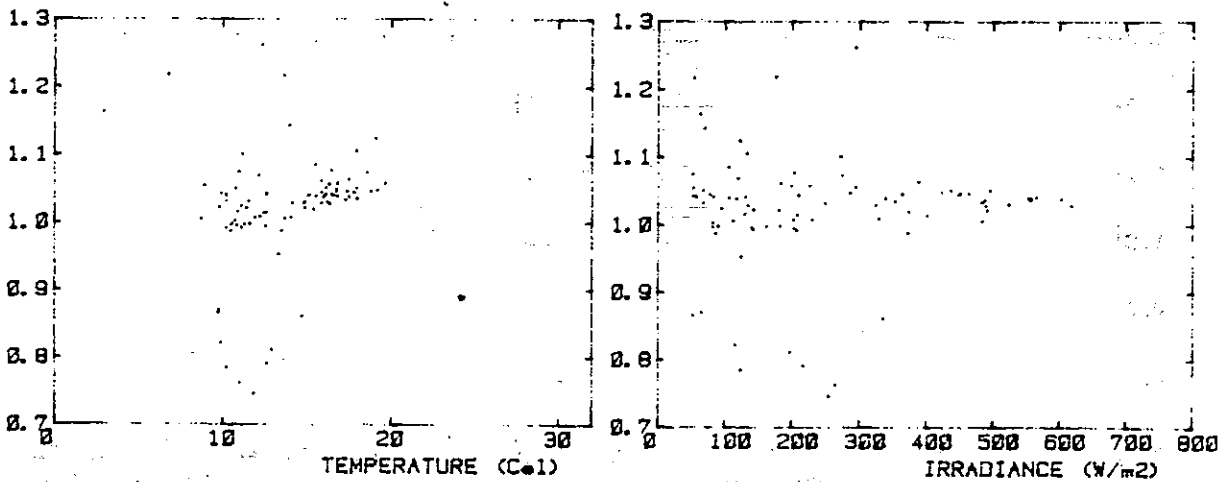
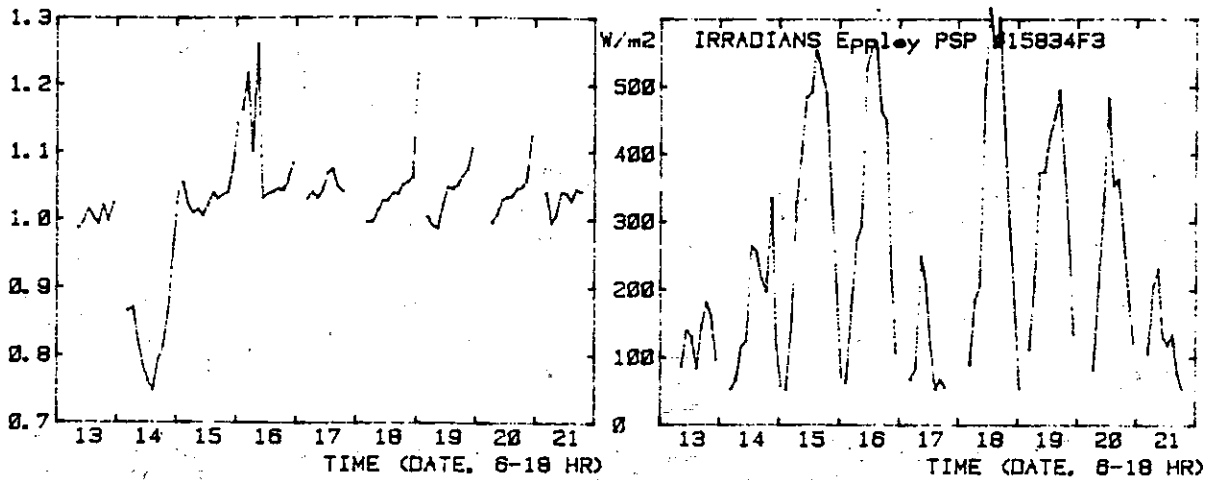



Figure 8 i

SOLAR IRRADIANCE RELATIVE EPPLEY PSP #15834F3 (8.75 mV/kW/m²)

Pyranometers LI-COR LI-200S #2381 with responsivity: 8.2 mV/kW/m²

Horizontally mounted

Borås, Sweden 13-21 September 1980

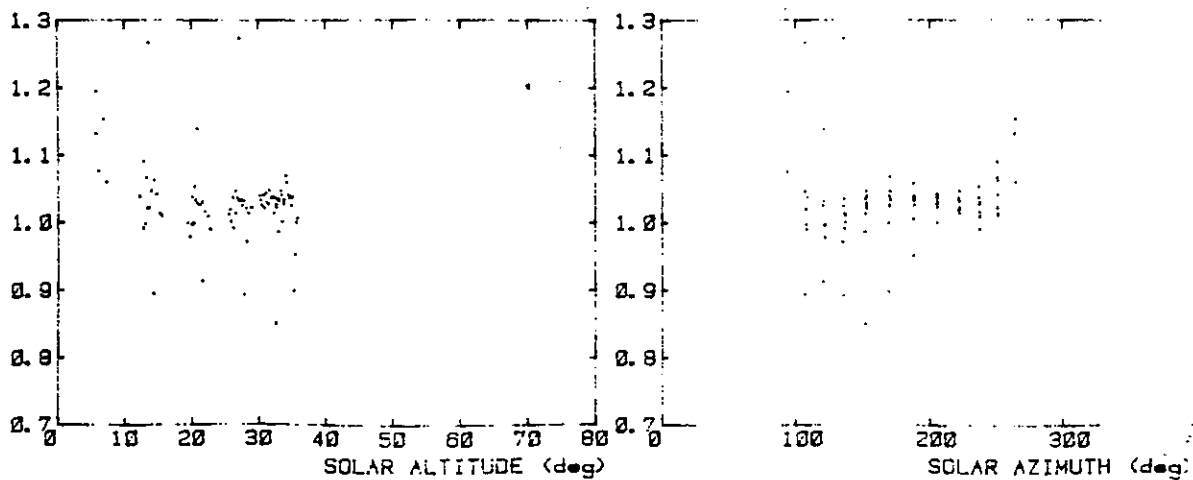
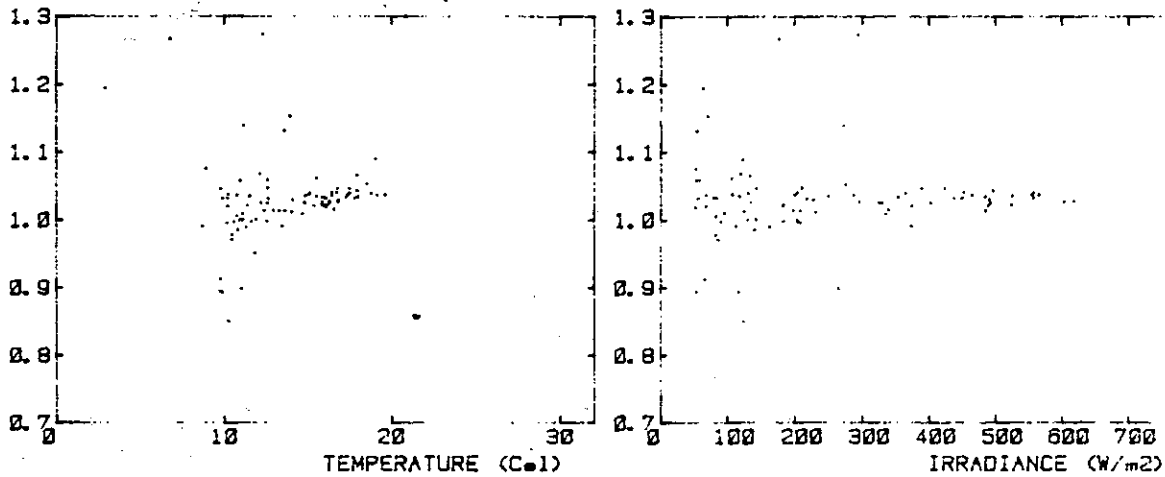
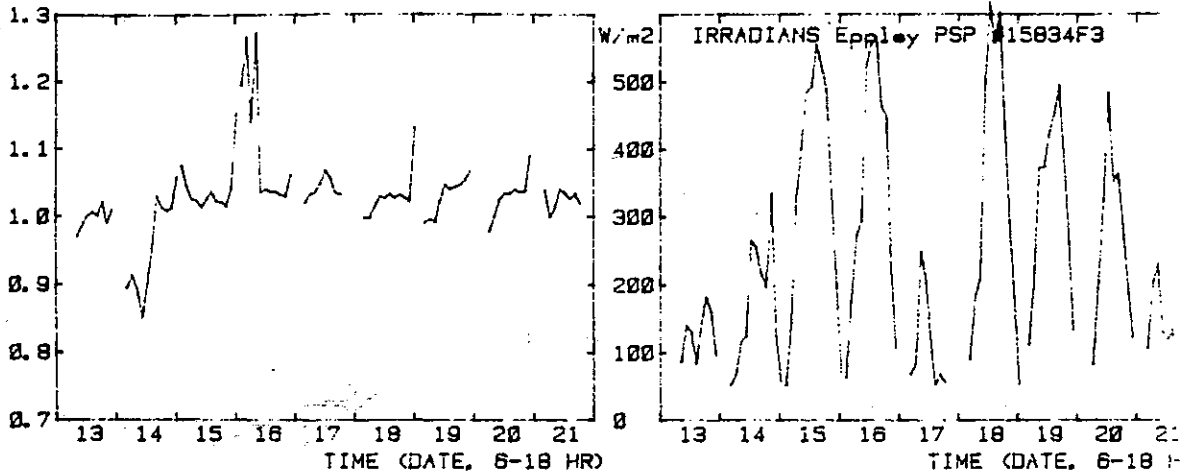
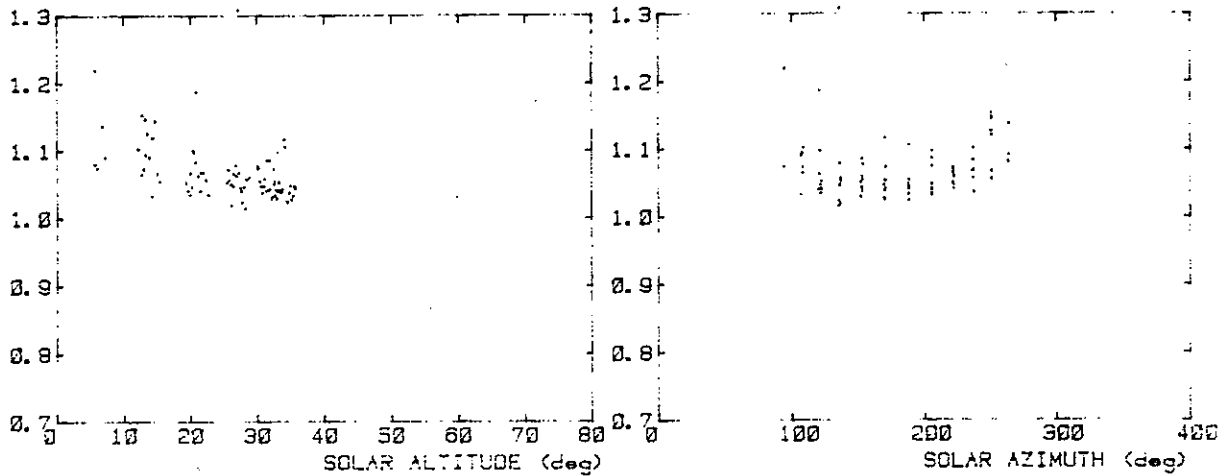
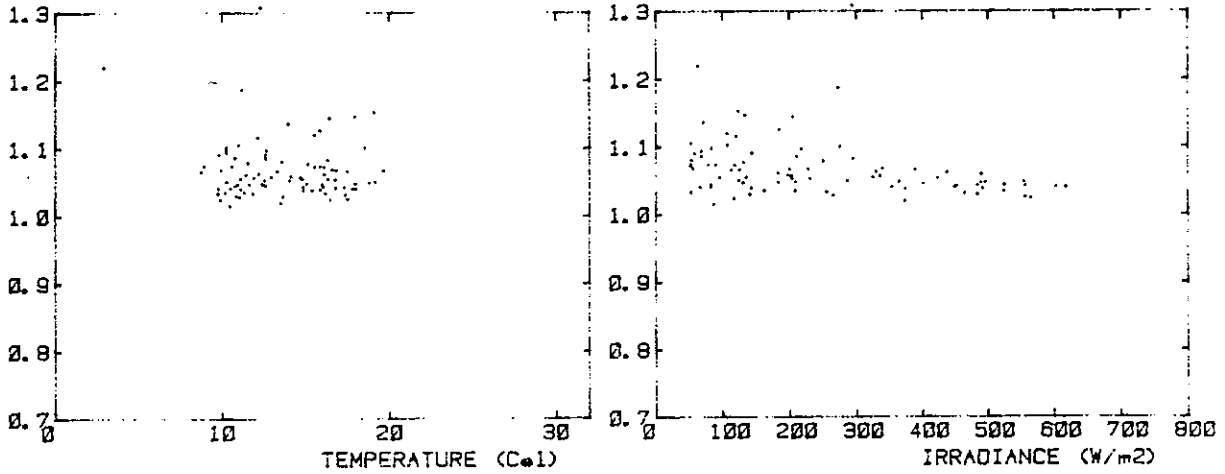
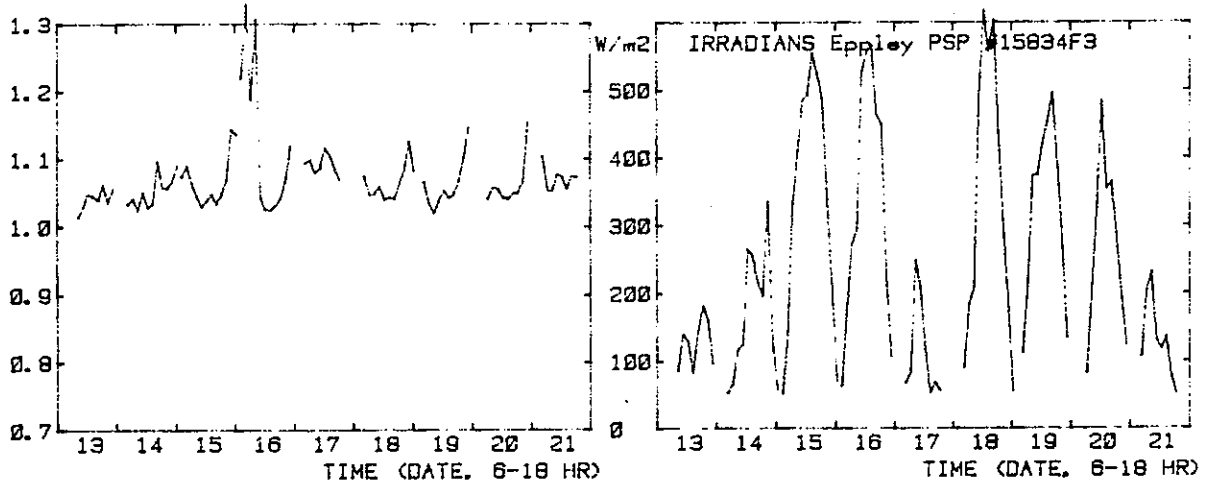



Figure 8 j

SOLAR IRRADIANCE RELATIVE EPPLEY PSP #15834F3 (8.75 mV/kW/m²)
Pyranometers Hollie MR-5 #1996 with responseivity: 71.75 mV/kW/m²
Horizontally mounted
Borde, Sweden 13-21 September 1980



APPENDIX T

**Brief Description of Pyranometer Calibration
Techniques Used by IEA Participants**

Compiled by

Michael Riches
U.S. Department of Energy
Office of Energy Research ER-12
Washington, D.C. 20545
U.S.A.

**Brief Description of Pyranometer Calibration
Techniques Used by IEA Participants**

February 1981

Compiled by Michael R. Riches

U.S. Representative Task V, Solar Heating and Cooling

Contents

- Letter to Participants
- Addressees
- An Example of Pyranometer Accuracy Assumptions
- Responses
 - Austria
 - Belgium
 - Canada
 - Denmark
 - Germany
 - Joint Research Center (EC)
 - Swiss Meteorological Service
 - Swiss IEA Task III (FIT)
 - Swiss IEA Task III (Federal Institute for Reactor Research)
 - United Kingdom
 - United States of America

1980-11-13

TO: Participants in Task V, IEA Solar
Heating and Cooling Programme

Dear Colleague:

At the recent Toronto experts' meeting of IEA Task V, we elected to support Task III in its pyranometer testing subtask. As a first step in this process we agreed to collect planning information on pyranometer calibration and comparison from each of our national radiation calibration facilities as well as provide our own experiences. Therefore I would appreciate your providing the following information:

1. a brief (one to two pages at most) description of how you calibrate pyranometers (e.g. artificial light - diffusing sphere, or direct beam; outdoor - shade disc, or direct comparison). Please include details like weather, length of exposure, intensity specifications etc., as well as general calibration philosophy.
2. by example (if possible) your experiences on comparing pyranometers after calibration by different methods or laboratories. For example, do you find a consistent difference between your calibration and a manufacturer's; do you find a wide (5%) spread on calibrations from a particular method or laboratory; do different types or series of pyranometers typically yield different results with varying calibration methods and/or exposure conditions? Again only a few pages of information is required at this time.
3. What other tests do you do on sensors? (e.g. temperature response, cosine, linearity, etc.)?

Mike Riches has agreed to compile this data for a Task III/ V only handout. Please send the material directly to Mike at:

Michael R. Riches
U.S. Department of Energy
Office of Energy Research, ER-14
Mail Station G-256
Washington, D.C. USA 20545

Please mail the material by December 15, 1980.

Sincerely,

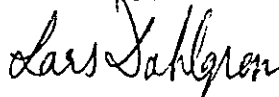

Lars Dahlgren, Chairman
IEA Task V Solar Heating and Cooling

cc: S. Blum
N. Jennings
P. Sens
E. Öfverholm

IEA SOLAR HEATING AND COOLING PROGRAMME

TASK V: USE OF EXISTING METEOROLOGICAL INFORMATION FOR SOLAR ENERGY APPLICATION

Dr. F. Neuwirth
Zentralanstalt für Meteorologie
und Geodynamik
Hohe Warte 38
A-1190 Wien

Mr. R. Dogniaux
Institut Royal Meteorologique
Avenue Circulaire 3
A-1180 Bruxelles

Dr. Thorne K. Won
Meteorological Application Branch
Atmospheric Environment Service
4905 Dufferin Street
Downsview Ontario, M3H, 5T4

Mr. H. Lund
Thermal Insulation Laboratory
Technical University of Denmark
Building 118
DK-2800 Lyngby

Dr. C. Gandino
CEC Meteorological Observatory
I-210 20 Ispra (Varese), Italy

Dr. K. Dehne
Deutscher Wetterdienst
Meteorologisches Observatorium
Hamburg
Frahmredder 95
D-2000 Hamburg

Dr. Franco Vivona
Consiglio Nazionale Ricerche
Progetto Energetica
Via Nizza 128
00198 Roma

Mr. A. J. Frantzen
Koninklijk Nederlands
Meteorologisch Instituut
Postbus 201
3730 AE de Bilt

Mr. Luis R. Nadal
Inst. Nacional de Tecnica
Aerospacial
Torrejon de Ardoz
Madrid

Dr. Lars Dahlgren
Swedish Meteorological and
Hydrological Institute
Box 923
S-601 19 Norrköping

Dr. Peter Valko
Schwiez, Meteorologische
Zentralanstalt
Krahbühlstrasse 58
CH-8004 Zurich

Mr. W. Gordon Durbin
U.K. Meteorological Office
Eastern Road
Bracknell RG 12, 2UK
Berkshire

J. W. Grüter
KFA
Programme for Solar Energy
Jülich 1
Postfach 1913
D 5170
Germany

H. Talarek
KFA
IKP - Solar Energy Branch
Jülich 1,
Postfach 1913
D 5170
Germany

Dr. Manfred Bruck
Austrian Solar and Space Agency
Gernisongasse 7
A-1090 Wien

Dr. E. Aranovitch
European Commission
Joint Research Center Euratom
I-210 20 Ispra (Varese), Italy

Dr. A. Hardt
Projektleitung Energieforschung
Kernforschungsanlage Jülich GmbH
Postfach 1913
D-5170 Jülich

Dr. A.P. van Ulden
Koninklijk Nederlands
Meteorologisch Instituut
Postbus 201
3730 AE de Bilt

THE FLUCTUATION OF SOLAR IRRADIANCE IN HONG KONG

C. T. LEUNG

Department of Mechanical Engineering, University of Hong Kong,
Hong Kong

(Received 29 April 1980; revision accepted 25 July 1980)

Abstract—Measurements of the total global solar irradiance on a horizontal surface in Hong Kong during the 10-yr period 1969–78 are analysed. Mean annual, monthly and daily totals and their frequency distributions are computed and examined. The seasonal and climatic effects on the fluctuation of solar irradiance in Hong Kong are discussed. The effect is particularly large during the spring months when the transition from cold to warm weather occurs.

The diurnal variation of total global solar irradiance in Hong Kong is also examined and the measured hourly data are observed to be in good agreement with Liu and Jordan's procedure of estimation from daily totals.

Results of regression analysis relating total solar irradiance with duration of bright sunshine hours based on data for Hong Kong are summarized. The yearly regression coefficients are found to be varying in an unsystematic manner.

Estimation of the Hong Kong monthly average diffuse solar irradiance based on the correlation with the cloudiness index is also performed and the results are found to vary between $7.39 \text{ MJ m}^{-2} \text{ d}^{-1}$ in the summer and $4.44 \text{ MJ m}^{-2} \text{ d}^{-1}$ in the winter.

1. INTRODUCTION

Solar insolation data for most parts of the world are now available. However, such information for the region of South East Asia, especially China is scarce. The present study is carried out to provide more detailed solar irradiance information for the designers of solar energy utilization systems under the climatic conditions of Hong Kong. Although the analysis is based on the data collected in Hong Kong at a station (King's Park) located at $22^{\circ}19'N$, $114^{\circ}10'E$, it may also serve as a useful reference for system designers and users in other subtropical regions of Asia and elsewhere which have the similar climatic conditions.

Measurements of the daily total global solar irradiance and duration of bright sunshine have been carried out in Hong Kong by the Royal Observatory for many years since June 1958 up to the present. Daily observations of the duration of sunshine are recorded by the Campbell–Stokes type heliograph and values of the total global solar irradiance are obtained from recordings of a bimetallic actinograph, British Meteorological Office Pattern Mk III, with a wavelength range between 0.3 and $4 \mu\text{m}$ and accuracy to within 5 per cent. The instrument has been calibrated against a standard recorder at the Kew observatory, and all the measurements presented in this paper are based on the International Pyrheliometric Scale of 1956 (IPS 1956). Unfortunately, continuous and reliable records may not be available for some appreciable long periods due to the malfunctioning of instruments and lack of calibration. Much of the present work is based on the statistical analysis of a continu-

ous set of data available for the 10-yr period between 1969 and 1978. On the other hand, the recordings of the total global solar irradiance on an hourly basis have been obtained only since December 1978. The measurements on hourly data are made by means of a thermo-electric pyranometer of the sealed thermopile dome solarimeter type, manufactured by Kipp and Zonen, Delft, Netherlands. The instrument has a wavelength range of 300 nm – $2.5 \mu\text{m}$, and accuracy within 1 per cent. It is calibrated against an Eppley Ångström Pyrheliometer and the radiation reference employed is also The International Pyrheliometer Scale (1956). The preliminary analysis on the Hong Kong hourly data presented in this paper is based only on the 12-month period between December 1978 and November 1979.

In this paper, the average values of the monthly, yearly daily totals of global solar irradiance in Hong Kong are presented and the seasonal effects on the frequency distribution are discussed. The diurnal variation of solar irradiance and the validity of Liu and Jordan's [1] procedure of estimating hourly totals from daily values in Hong Kong are then examined. The characteristics of the yearly variation of sunshine duration in Hong Kong and its correlation with total solar irradiance are discussed. Finally, the monthly average values of diffuse irradiance in Hong Kong are estimated by two different methods and compared.

2. GENERAL CLIMATE OF HONG KONG

The territory of Hong Kong which consists of the Hong Kong island proper, the peninsular of Kow-



ÖSTERREICHISCHE GESELLSCHAFT FÜR
SOLAR ENERGIIE UND WELTRAUMFRAGEN G.E.S.M.B.H.
AUSTRIAN SOLAR AND SPACE AGENCY (ASSA)

A-1090 WIEN, GARNICONGASSE 7, TEL. (0222) 43 61 77-0, 43 60 31-0
TELEX: 76550 assa a, TELEGRAMM-ADRESSE: ASSASPACE WIEN

Herrn
Dr. H. Talarek
Kernforschungsanlage Jülich GmbH
IKP-Solar Energy Branch

Vienna, 1980 12 01
1628/MB/es

Postfach 1913
D-5170 JÜLICH

Pyranometer comparison test

Dear Sir,

The documents of the Task V-Toronto-meeting seem to show that Austria's participation (Messrs. Schenk) at the pyranometer comparison test is not provided, as only the Kipp & Zonen and Eppley-equipments are mentioned in the corresponding documents.

In this context I would like to point out again that Messrs. Schenk are prepared to place a maximum of 12 pyranometers at your disposal for the comparison test, and that we also lay stress on the consideration of these equipments within the framework of the IEA-project mentioned above.

With kind regards,

M. Bruck

cc/Mr. Dahlgren

Dr. Fritz Neuwirth
ZENTRALANSTALT FÜR
METEOROLOGIE UND GEODYNAMIK

A-1190 WIEN, HOHE WART 38

DIREKTOR:
UNIV.-PROF. DR. HEINZ REUTER

WIEN, den 16.12.1980

TELEFON 0222/36 44 53

PSK 5050257

TO: Michael R. Riches
U.S. Department of Energy
Office of Energy Research, ER-14
Mail Station G 256
Washington, D.C.
USA 20545

Reference: Letter of Lars Dahlgren from 1980-11-13
pyranometer testing subtask

Dear Colleague:

This is the required information on pyranometer calibration in Austria at the Central Institute for Meteorology and Geodynamics, whereby this information I have received from O. Motzchka and E. Wessely, who perform this calibration procedures regularly in our institute.

ad 1.: In the Austrian radiation measuring network Schenk-star-pyranometers are used exclusively.

As standard instruments for the calibration procedure Angström-pyrheliometers are used, which are connected to the World Radiation Center Davos in the frame of the International Pyrhelio-meter Comparison, and also actinometers (e.g. Linke-Feußner-Actinometer). By means of these standard instruments three selected pyranometers were calibrated continuously in natural conditions, and these pyranometers are used as reference pyranometers. The calibration procedure for these reference pyranometers is carried out outdoor during direct beam by the shadowing method with different sky radiation (measurements in 200 and 3100 m altitude above sea level).

These reference pyranometers are used for the control calibration of the pyranometers in the radiation measuring network by half to one-hour measurements, which are performed halfyearly and simultaneously during the momentary radiation situations.

In the case of the first calibration of a pyranometer, this pyranometer and the reference pyranometers are connected to a data acquisition system. The duration of these comparing measurements depends on the following requisitions: For the calibration should be available in any case at least three days without clouds, with varying clouds and with overcast. Therefore in practice such a calibration procedure will last about three weeks. As smallest time increment in this method one hour is used. By this data acquisition system also the sky radiation is measured, therefore the following examinations of the calibration factors are on hand:

- a) The calibration factors are existent for the different radiation conditions and must be the same for all these conditions.
b) The spectral total sensitivity can be checked.
c) The time constant of the instruments can be estimated

Shadow Disk →
A + LINK F

DAG: 1 hr Sample
37 days Days
over 3 weeks

conditions?

d) Daily variations of the calibration factors should not be existent. If so, they are caused by bad cosine response and dependence on azimuth.

ad 2.): From own experiences there are known differences in the calibration factors, if the pyrometers are calibrated by artificial light (up to 15%). Calibrations under direct beam show calibration factors within $\pm 3\%$, which is recommended by WMO. Because of close cooperation differences in the calibrations between our calibration and the calibration of the manufacture are not yielded.

15%
M-F-F-W
CIG
0 ± 3%

Apart from differences in the sensitivity between pyrometers of older type of construction (about 5 years ago) and the new actual pyrometers there have not appeared any suspicious differences in the specifications. Differences to the black-surface-instruments in comparison to the starpyrometer are existent.

ad 3.): Regularly the star pyrometers are tested indoor with regard to the cosine and azimuth response. From time to time in the laboratory linearity tests are performed, also tests about the negative temperature coefficient (negative output during darkening as e.g. with black-surface-instruments).

Yours sincerely,

F. Neuwirth

F. Neuwirth

INSTITUT ROYAL MÉTÉOROLOGIQUE

DE
BELGIQUE

N°

à rappeler avec la date

Annexe

TÉLÉPHONES :

DIRECTION : 74 43 00

AUTRES SERVICES { 74 67 87
74 02 79
74 09 41
74 02 48

Uccle-Bruxelles 18, le January, 19th, 1981
AVENUE CIRCULAIRE, 3

Mr. Michael R. Riches
U.S. Depart. of Energy
Office of Energy Research ER-14
Mail Station G - 256
U.S.A.--Washington, DC, 20545

Concerned : Support to IEA Task III : pyranometer's comparisons.

Dear Mr. R. Riches,

I received your letter dated January 9th, claiming a response to the collect of informations concerning the pyranometer calibration procedures applied in our meteorological office in Belgium.

First of all I would like to confirm my position concerning the organization of such comparisons by agencies other than W.M.O. W.M.O. and particularly its Working Groups on Radiation undertake to plan pyr heliometric comparisons every about 5 years on a international basis. Beside these comparisons of the standards instruments of the Regional Centers, comparisons of the national standard pyr heliometers are regulary performed in a regional basis (for Region VI at least) in accordance with the W.M.O. regulations.

The responsibility of calibration for pyranometers and other secondary radiometers devolves of the national radiation centers or, by lack of facilities, to the W.M.O. regional radiation centers.

in point? → The methods of calibration are well known and are described in detail particularly in the W.M.O. Guide on Instruments and Methods of Observations.

→ If some systematic divergences appeared in the results of some previous comparisons such the last one in March 1980 in Davos, the explanation of which is to hunt not about for the method but for the values of the Davos's instrument adopted as references.

These reasons justify my decision to does'nt participate to the

./.

INSTITUT ROYAL MÉTÉOROLOGIQUE

DE
BELGIQUE

N°

à rappeler avec la date

Annexe

TÉLÉPHONES :

DIRECTION : 74 43 00

AUTRES SERVICES { 74 67 87
74 02 79
74 09 41
74 02 48

II.

Uccle-Bruxelles 18, le January, 19th, 1981.
AVENUE CIRCULAIRE, 3

Mr. Michael R. Riches
U.S.A.-Washington, DC, 20545

./.

exchange of pyranometers carried out by the task III.

This being said, you will find in the annexed sheet my response to the questionnaire of Mr. Dahlgren.

With my kindest regards,

Yours sincerely,

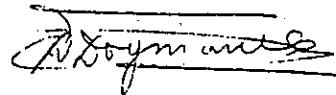

R. Dogniaux.

Information concerning the calibrating procedure of pyranometers used in the Royal Meteorological Institute of Belgium

1.- Method of direct outdoor calibration against direct sun's beam as reference source measured by our standard pyr heliometer according the procedure described in the W.M.O. Guide on Instruments.

The same shade disc used for the records of sky radiation is used during the calibrations.

- We characterize the turbidity of the atmosphere by the Linke turbidity factor, which implies clear sky conditions.

*cosine constant -
Calculation of direct
beam?* - Length of exposure : depending of the time of response of the sensors and of the stability of the radiation : generally alternances of 4 minutes between sun and non sun exposures can be accepted.

2.- Very often important differences between our calibration factors and those given by the manufactures are found. There are several possible explanations for that :

a/. - the manufactures are not equipped with adequate references standard

b/. - the procedures of calibration are different (lamps, diffusing sphere, sun)

c/. - some ageing effect of the thermopiles can affect the original calibration.

Environment 3.- Independent tests of temperature response, cosine deviation and linearity are performed in a laboratory calibrating test chamber especially built for the study of the characteristics of the radiometers and of the effect of the environment on their behaviour.

Uccle, January 19th, 81.

R. Dogniaux.

Pyranometer Calibration Procedures at the
Canadian National Atmospheric Radiation Centre

A Short Description for I.E.A. Task III and Task V

Standards

The primary standard for atmospheric radiation measurement in Canada is derived from a group of pyrhemometers including Abbot silver disc pyrhemometers, Angstrom pyrhemometers and two absolute cavity radiometers. These are intercompared regularly during annual visits to Mt. Kobau in British Columbia and at least one of them has been present at all WMO-IPC comparisons.

Radiation Scales

Since 1960 the IPS (1956) as defined by the Smithsonian Scale of 1913 - (2%) has been the Canadian Reference. As maintained by NARC since 1970 (and as distinct from the other definition of IPS based on the Angstrom Scale) this scale can be demonstrated as identical to the new World Radiometric Reference to within 0.3% or less.

Reference Pyranometers

A group of ten or so reference pyranometers are calibrated from the standard pyrhemometers on a two-yearly schedule at Mt. Kobau, usually in July. The transfer is made both by occultation and via two Convertible Abbot pyranometers.

Sphere Calibration

The calibration procedure for the two hundred or so pyranometers that pass through NARC each year is by the sphere method. The signal from the pyranometer under test is compared with those from one or two reference pyranometers of like manufacture while all are inside a six (6) foot diameter diffusing sphere in the laboratory.

Other Regular Tests

- (i) The temperature coefficient of response is measured on every tenth pyranometer.
- (ii) Unless there is special reason not to do so, the pyranometer is adjusted so that the direction of maximum sensitivity is vertical.

Some Comments on Accuracy and Reproducibility

- (i) The definition of sensitivity of a non-Lambertian pyranometer requires (but seldom receives) care in formulaing. Essentially, we take a mean on each sunny day in July at the Mt. Kobau site during the four hours on either side of local solar noon. As such, the numbers reproduce within a total range of 2%.

- (ii) The two distinct transfer methods from pyrhelimeter to pyranometer agree to 0.5% r.m.s.
- (iii) The relation between laboratory sphere calibration and field calibration depends on individual instruments. For example, the difference with Eppley model 2's and P.S.P.'s is usually small but occasionally can be as much as 2%. A similar discrepancy would result if a CM6 ere calibrated in the sphere against P.S.P.'s.
- (iv) The error in the absolute calibration by the sphere method with the definition (or perhaps caveat) is, in the light of the above uncertainties and others, considered to be 3% or less.
- (v) The reproducibility and stability of the sphere method can be estimated from the following. In a sample 244 cases of two or more calibration separated by two years or more being done on the same instruments, 69% exhibited a change of less than 0.5%.
- (vi) Agreement with Manufacturer's calibrations. It is assumed that both manufacturer's use the IPS Angstrom scale which differs by 2.2% (IPC IV) from the WRR which (see above) is already the scale used by NARC. Thus, one should expect.

$$\frac{\text{Manufacturer's sensitivity}}{\text{NARC sensitivity}} = 1.022$$

The actual situation is that the Kipp values since 1973 have been in serious disagreement.

KIPP/NARC			EPPLEY/NARC		
1971-73	1.017 ± .013	(75)	69-75	1.029 ± .008	(53)
1976-78	1.076 ± .011	(22)	76-78	1.035 ± .019	(16)
1979-80	1.076 ± .010	(18)	79-80	1.038 ± .011	(40)

D.I. Wardle
2/2/81

THERMAL INSULATION LABORATORY
TECHNICAL UNIVERSITY OF DENMARK

Building 118
DK-2800 Lyngby, Denmark
Telephone: 2-89 35 11
Telex: 37529 DTHDIA DK
1981-02-01
HL/hg

Mr. Michael R. Riches
U.S. DOE
Office of Energy Research
Suite 123, Amtrak Building
400 N. Capital St. NW
Washington D.C. 20585
USA

Conc.: IEA Solar Heating and Cooling Programme
Calibration of pyranometers.

Dear Mike,

Please find herewith my reply to the question in Lars Dahlgrens
letter.

Sorry for the delay!

Sincerely yours

Hans Lund
Hans Lund

1981-02-02

Calibration of pyranometers in Denmark

This is answers to questions made by Dr. Lars Dahlgren, chairman of IEA, Solar Heating and Cooling programme, Task V.

1. In Denmark no systematic calibration of pyranometers has taken place. The manufactures calibration has been used except in one institution mentioned below.

At the Thermal Insulation Laboratory the manufactures calibration has been checked in a few cases, with an Eppley Ångström Pyrheliometer and a shading disc, instantaneous measurements. No errors was found.

At the Royal Veterenary and Agricultural University, Hydrotechnical Laboratory all instruments have for some years been calibrated under a tungsten lamp by comparison with an Eppley pyranometer.

With a comparison in natural climate over some days we have shown that this calibration has bad given results and it will be revised, or the original manufactures calibration will be used.

2. No particular experiences exist here, except as mentioned above. 10 Kipp and Zonen CM5 pyranometers of various ages and 1 Epply were compared. No clear conclusions could be drawn, connecting age or serial numbers with calibration factor.
3. No other systematic tests.

Hans Lund

Dr. K. Dehne in
DEUTSCHER WETTERDIENST
Meteorologisches Observatorium Hamburg

Frahmredder 95
2000 Hamburg 65

Tel. 040/601 79 24
Telex 02162912 DWSA D

Az.: --

Datum: 20. Jan. 1981

Michael Riches
U.S. Department of Energy
Office of Energy Research, ER-14
Mail Station G-256

Washington, D.C., U.S.A. 20545

Subject: Pyranometer calibration
Ref.: IEA Task V - Circular of 1980-11-13
Your reminder of 1981-1-9
Encl.: 1

Dear Mike:

Enclosed I am sending you my contribution to the Task V-
inquiry of November 1980. Later on I will try to deliver
more detailed information to item 2.

I apologize my late answer.

With best wishes for 1981

Yours sincerely



Item 1.

General remarks on the calibration routine for pyranometers at
Meteorologisches Observatorium Hamburg

Outdoor calibration:

- 1) Normally, the pyranometers are calibrated using the direct solar radiation I measured by a standard pyr heliometer according to the formula: $I \cdot \sin \gamma = G - D$. D (diffuse sky radiation) is determined by the same pyranometer to be calibrated, using a shading disk.
- 2) Since this method requires fine weather conditions which are rare at Hamburg, only the standard pyranometers and special pyranometers are calibrated by this method. To obtain more data for statistics especially in the case of non-stable weather conditions, an 1-minute-procedure is used to measure G and D .
- 3) As calibration factors, the values close to the solar zenith angle of 60° are used because this is about the mean value of German latitudes. Furthermore, the calibration factors are converted to 20°C in order to have the same temperature conditions as at the indoor calibration. A temperature correction of the network data will be performed at a later time by means of a computer routine.
- 4) The calibration of network pyranometers by a standard pyranometer using global radiation generally requires several weeks and is therefore not introduced as routine method.

Indoor calibration:

- Xenon source
High E_h, UV*
- 1) Normally, network pyranometers are calibrated indoors using a standard pyranometer. As radiation source, a xenon high pressure lamp with a sun-similar spectrum is used.
 - 2) Assuming the sensitivities of different solarimeters of type CM 5 to depend on the incidence angle in a similar manner, the normal beam incidence on the horizontal receiver surface was applied for calibration. But recent measurements of the "cosine response" of different

pyranometers showed that this assumption is not justified in many cases. To obtain more accurate calibration factors, a tiltable mount for the pyranometers has just been installed which offers the opportunity to calibrate at different angles of incidence. The tilt effect can now be corrected for.

- 3) The calibration factor is evaluated from the difference: Signal after 1 min irradiation minus signal after 1 min shading. Only in case of big differences in the time response of the standard pyranometer and the network pyranometer, a longer period for irradiation and shading should be used.

S-D

It may
input I??

A summary of the calibration routine is given on page 3.

Item 2

- 1) We do not have great experience in comparing pyranometers calibrated by different methods. Only a few pyranometers have been calibrated both outdoors and indoors. The results generally differ by less than 2%.
- 2) The differences between the calibration factors given by the manufacturer Kipp & Zonen and determined by us, respectively, are generally between 0 and -3%. vs consider 7% !!
- 3) In general, global irradiance measured by different pyranometers differs by ± 1% or less as far as the hours around sunrise and sunset are excluded.

2% Δ
indoor
outdoor

Item 3

The following specifications of pyranometer can be tested at the Obser -
atory: Time response, temperature response, non-linearity, tilt effect,
azimuthal error and cosine error. The test procedures are summarized on
the tables on pages 4 and 5.

Calibration routine for pyranometers at Meteorologisches Observatorium Hamburg

Type	Method	Procedure	Source Type	Source μm^{-2}	Incid.	Angles Azim. Mean	Tilt	T/ $^{\circ}\text{C}$
Outdoor	Comper. with Stand.-Pyrehel.	Sum: 1 min Shade: 1 min	Sun (+Sky)	500-900	60 $^{\circ}$	$\approx 45^{\circ}$ (cable out-let to north)	0 $^{\circ}$	Correct. to 20 $^{\circ}\text{C}$
Indoor	Comper. with Stand.-Pyranom.	Beam: 1 min Shade: 1 min	Xenon-lamp X80 450 W	300	0 $^{\circ}$	--	0 $^{\circ}$	Climate chamber 20 $^{\circ}\text{C}$

Remarks on outdoor calibration:

- 1) Weather conditions: Quasi cloudless sky. No wind from the direction of solar azimuth angle. Required stability of signals of perheliometer: better than 1 %.
- 2) Pyreheliometer standards: Angström-Pyreheliometer 568; Absolute Red. PM6-4; Working standard: Linke-Feußner-Aktinometer Nr. 77
- 3) Shading device: Disk (ϕ 6 cm) on a thin rod, manually shifted. Shading angle: 10 $^{\circ}$.
- 4) The 1min-period of "sun and shade" can deliver calibration factors up to 1 % too high according $\Delta J_{\text{v}} \neq 0$ to the time response of the pyranometers.

Remarks on indoor calibration:

- 1) New installation: Sledge for mounting standard pyranometer and network pyranometer side by side can be tilted by 30 $^{\circ}$, 45 $^{\circ}$ and 60 $^{\circ}$.
- 2) The 1min-period of "beam and shade" delivers for Kipp & Zonen Pyranometers within 0,5 % the same results as longer periods.
- 3) The homogeneity of the beam irradiances is within about ± 1 % over the area of the receiver surfaces.

1) Time constants

Aim: Determination of the time necessary for achieving a final value

Method: Recording of signals after shading the lamp (~ 3 order of magnitude).

Conditions:

Source	Recorder	Pyranometer
Lamp: XBO-450W Irradiance: $\approx 300 \text{ W/m}^2$ ↑ ?	Strip chart recorder, DVM, data scanner (sampling rate: 2 s^{-1})	Horizontal position in climatic chamber, unventilated. Preradiated: $\approx 300 \text{ s}$

Determination of measuring value: Signal (t) minus Zeropoint (electr.)

2) Temperature response

Aim: Sensitivity as function of Temperature

Method: Irradiation of pyran. in a climatic chamber by an extern lamp.

Conditions:

Source	Climatic chamber	Recorder	Pyranometer
Lamp: XBO-450W Irradiance: $\approx 300 \text{ W/m}^2$ ↑	$-20^\circ\text{C} \rightarrow 40^\circ\text{C}$, $\Delta t = 10^\circ\text{C}$, low rel. humidity	DVM (high stabil.), strip chart recorder.	Horizontal Position. Ventilation by circulation of chamber air.

Determination of measuring value: Signal after 1 minute of irradiation minus signal after 1 minute of shading

3) Non - linearity

Aim: Sensitivity as function of irradiance

Method: Attenuation of beam by a rotating sector disk

Conditions:

Source	Rotating sector	Recorder	Pyranometer
Lamp: XBO-2,5 kW Irradiance: 1 kW m^{-2} (Achromatic lenses)	Slit height: 6 cm; 1=60 Hz. Sector positioned in the focus of the 1. achrom. lens.	DVM	Vertical (or horizontal) position. Ventilated.

Determination of measuring value: As for 2)

4) Tilt effect

- 5 -

Aim: Sensitivity as function of the tilt angle of the pyranometerMethod: Pyranometer irradiated independent of tilt angle by diffuse radiation of the whitened internal walls of a turnable drum.Conditions:

Source	Turnable drum	Recorder	Pyranometer
Lamp: XBO-2,5 kW Irradiance: 1 kW m^{-2} (Independency on tilt angle; controlled by silicon cell)	Cylindrical design, symmetrical axis = rotation axis (hollow axis for entrance of light positioned in focus of achrom. lens). MgO-whitened. Air circulation.	DVM	Flanged to an opening in the drum jacket Glas dome inside drum ventilated.

Determination of measuring value: As for 2)5) Azimuthal responseAim: Sensitivity as function of azimuthal angle.Method: Pyranometer turned around an axis perpendicularly to the receiver surface and irradiated by a fixed beam (quasi homogeneous and parallel) at selected angles of incidence.Conditions:

Source	Turntable for Pyranometer	Recorder	Pyranometer
Lamp: XBO-2,5 kW Irradiance: $\approx 250 \text{ W m}^{-2}$ Inhomogeneity within 25 mm β : $< 1\%$ Divergence: $\alpha \approx 6^\circ$	Combination of vertical turntable for mounting the pyranometer (adjustment of azimuth angle) with horizontal turntable (adj. of angle of incidence)	DVM	Vertical position. Ventilated. Angle of incidence 60° and 80° .

Determination of measuring value: Signal reading every 30 s (before the exchange of azimuth angle).6) Cosine errorAim: Sensitivity as function of angle of incidence.Method: Pyranometer (vertical positioned) turned around an virtual vertical axis (equal to the diameter of the receiver surface) for variation of the incidence angle of a fixed horizontal beam.Conditions:

Source	Turntable for Pyranometer	Recorder	Pyranometer
As for 5)	As for 5)	As for 5)	Vertical position. Ventilated. Incidence region: $-90^\circ \rightarrow 0^\circ \rightarrow 90^\circ$. Angle of azimuth: cable outlet to the left side or to nadir.

Determination of measuring value: As for 2)

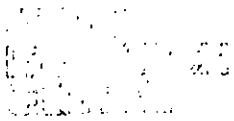

Ispra Establishment

21020 Ispra, Varese, Italy
Tel. (0323) 360271
Telex 320000 EUR I

HEAT TRANSFER DIVISION

Ispra, 20.1.1981
161/DET/69/81 CG/ir

U.S. DEPARTMENT OF ENERGY
Office of Energy ER 14
Mail Stop G-256 (Dr. Riches)
USA-205 45 WASHINGTON, D.C.

Dear Mr. Riches,

I have already sent to you a table with the small differences between Kipp & Zonen calibration and the check at Carpentraes (France). Another copy of that table is enclosed to this letter.

At Carpentraes they use outdoor comparison between a LINKE-FEUSSNER Pyranometer and global and diffuse irradiation on mine pyranometers, following the equation

$$H = H_d + H_b \sin (90 - \text{TETA})$$

The horizontality of a pyranometer is controlled by a new spiritlevel. Many cycles of 4 minute measurements of diffuse and global irradiation are carried out under different sun elevation.

The result is written in a certificate which contains many elements among which the number of micro-volt/milliwatt sqcm that one has to put into the integrator.

Thank you for having sent to me and Mr. Aranovitch many copies of the two reports of the IEA Task 4.

Sincerely yours,

409 C. Gandino

Meteorological Observatory of Ispra, 28-X-80.

COMPARISON BETWEEN THE ORIGINAL CALIBRATION CERTIFICATE (Kipp & Zonen) AND THAT MEASURED AT CARPENTRAS AFTER NEAR TWO YEARS OF USE AT ISPR: OF PYRANOMETERS (mVolts produced by one W/sqcm)

NUMBER OF ORIGINAL CALIBRATION NEW CALIBRATION AT
INVENTORY AT KIPP & ZONEN 1976-77 CARPENTRAS, France, 1979.

ALL PYRANOMETERS ARE CM5 AND ARE CALIBRATED FOR HORIZONTAL PLAN.

76+3487	123	123
76+3169	122	121
76+3176	118	117
76+3479	128	127
76+3450	128	128
76+3487	123	123
77+4152	129	126

These results show that the pyranometers used at Ispra loss only one percent per year of the original calibration, in agreement with the conclusion written by Ronald Latimer some years ago.

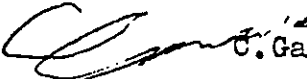
C. Gandino.

This is a sort of circular information sent to these adress:

- 1) Lars Dahlgren,
Swedish Meteorological Institut, S-601 19 Norrkoping, Sweden.
- 2) J.W. Grueter ,
Kernforschungsanlage, PB 1913, 517 Juelich, West Germany.
- 3) Michael R. Riches,
U.S. Departement of Energy, Office ER-14,
MS G256, Washington D.C. ~~2024~~ U.S.A. 20245

__o__o__o__o__



Schweizerische
Meteorologische Zentralanstalt

Institut Suisse
de Météorologie

8044 Zürich, 26th January, 1981
Krähbühlstrasse 58

Mr. Mike Riches
U.S. Department of Energy
Office of Energy Research
Satel. Power Syst. Prog. ER-55
400 N. Capitol St. N.W. M.S. 123

U.S.A. Washington, DC 20585

I/Zeichen:
V/réf.:

U/Zeichen: PV/bb
N/réf.:

Pyranometer Calibrations

Dear Mike,

Thank you for your circular letter of January 9th. I hope you have received my letter of December 24th, 1980 in this matter; a sheet showing some results of calibrations was enclosed. For security you will find attached a copy of my letter.

I am mailing you under separate cover a copy of "Klimatologie der Schweiz, Heft No 26/I" containing data on global and diffuse radiation measured at Swiss stations. Here you will find on pages 6-9 some information of earlier (1958-1972) pyranometer calibrations in Switzerland. The sheet you should have received with my letter is identical with Figure 8 in the reprint I send you now. We have calibrated the pyranometers against pyrhelimeter readings by the common shading method: several times a year in fine weather conditions at different solar elevation angles the pyranometer was shaded with a disc as shown in the reprint (left side of Fig. 2) during about 10 minutes (to allow for temperature compensation). Simultaneously direct sun intensity was measured by a pyrhelimeter. The pyrhelimeter (a Linke-Feussner type) was

again controlled regularly by comparisons with the Ångström standard absolute pyrheliometer of Davos.

Our new network of automatic weather stations are, as you perhaps know, all equipped with Kipp and Zonen pyranometers. The calibration principle of these devices (at present 45 stations are operating, 60 will operate in the next future) is the following:

1. The Davos Standard Pyranometer (DSP) is calibrated with the shading method against the Davos Standard Absolute Radiometer.
2. The Principle Pyranometer of the Swiss Met. Institute (PPM) is compared with DSP periodically at different seasons and times of day on clear days (global irradiance $\geq 500 \text{ Wm}^{-2}$).
3. PPM is also calibrated against a halogen lamp.
4. The halogen lamp is transported to all stations of the automatic network; by this each station is checked about once a year to control the calibration factor determined before the station has started to operate. This way the whole network should be kept adjusted to the PPM.

Under separate cover I also send you a copy of describing the method of calibrating the pyranometers in our automatic network together with a reprint giving a brief survey on the network itself.

Concerning the other questions in Lars Dahlgren's letter I believe, you are already informed by the Task III report. Yes, there are consistent differences if different calibration methods are applied. If you want to know more details Claus Fröhlich has to prepare some document - at present he has not prepared such a description.

I hope you may make some use of this information.

Best wishes,

P. Valko



Schweizerische
Meteorologische Zentralanstalt

Institut Suisse
de-Météorologie

8044 Zürich, 24th December 1980
Krähbühlstrasse 58

Mr. Mike Riches
U.S. Department of Energy
Office of Energy Research
Satel. Power Syst. Prog. ER-55
400 N. Capitol St. N.W. M.S. 123

U.S.A. Washington, DC 20585

I/Zeichen:
V/réf.:

U/Zeichen: PV/bb
N/réf.:

Dear Mike,

As agreed at our IEA V Toronto-meeting, I am sending you attached a sheet showing some results of Kipp-Zonen Pyranometer (horizontal exposure) calibrations. The figure shows that calibration factor practically does not depend on the solar height angle, air temperature and of the radiation intensity itself. The figure is based on calibrations during the period Apr. 8th, 1958 ~ Dec. 3rd, 1960 using a Linke-Feunner pyrhelimeter to measure direct intensity.

Thank you for sending me one separate copy of the IEA IV Handbook, it has arrived in the meantime. Also I thank you for the package with the sheets of Chapter 8 (with the original photographs) ready for printing. The other package with copies of the Handbook you sent me earlier has still not arrived.

Kind regards and best wishes
for the New Year

Peter

(ppa. B. Beccaro, secretary)

Enclosure

Calculations were made:
8.4.1958 - 3.12.1960



Abbildung 8. Abhängigkeit des Eichfaktors für das Globalstrahlungsgerät von Locarno-Mont I von der Sonnenhöhe (oben), der Lufttemperatur (mitte) und der Vertikalkomponente (unten) der direkten Sonnenstrahlung.



ÉCOLE POLYTECHNIQUE FÉDÉRALE DE LAUSANNE
EIDGENÖSSISCHE TECHNISCHE HOCHSCHULE - LAUSANNE
POLITECNICO FEDERALE DI LOSANNA

IEA
SOLAR ENERGY PROJECT
SWITZERLAND

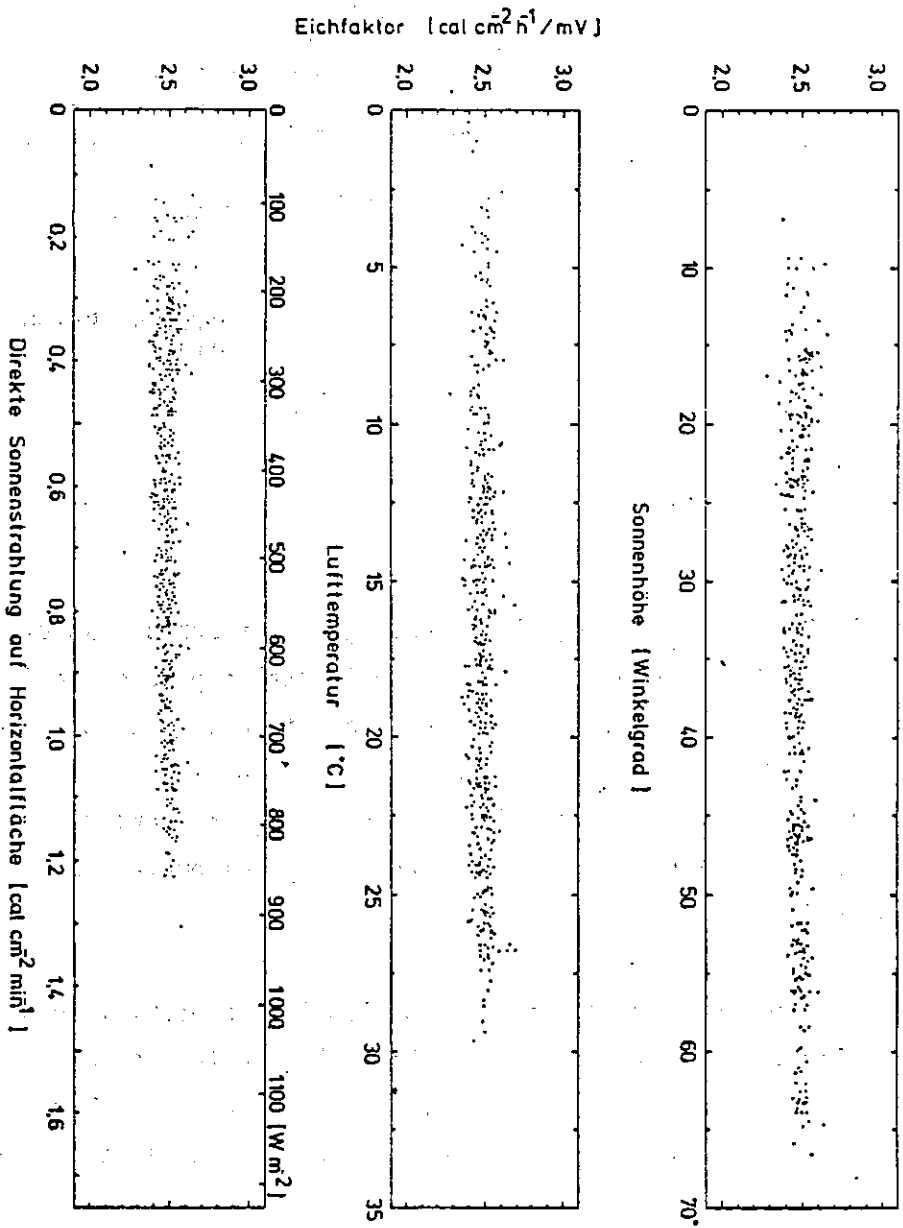
Case postale (P.O. Box) 1024
CH-1001 Lausanne/Switzerland

Téléphone (021) 47 11 11
Télex 24 478
Adresse: 14, av. de l'Eglise-Anglaise

Mr. MICHAEL R. RICHES
U.S. Dept. of Energy
Office of Energy Research, ER-14
Mail Station G - 256
Washington DC
20545 U.S.A.

Affaire traitée par A. Razafindraibe

☎ (021) 47 34 27

Vitré.

Nitré. AR/qhc

Lausanne, December the 16th. 1980

Subject : Round-Robin calibration

Dear Sir,

Invited by Dr. H.D. Talarek, Operating Agent of Task III, via Dr. J.M. Suter, participant in Task III in Switzerland, please find herewith different papers concerning the KIPP-ZONEN instrument which one is already sent to you by Dr. J.M. Suter. (Kipp-Zonen type CM5, Serial No. 785047).

Hoping that those information will be useful for you, we remain,

Yours faithfully,

A. Razafindraibe
Solar Energy REsearch Groupe
Federal Institute of Technology
Lausanne - Switzerland

PYRAMOMETERS CALIBRATION AND COMPARISON

I. How calibrate Pyramometers.

- * Direct comparison with a standard KIPP-ZONEN calibrated at the WRC in Davos, Switzreland.
- * Length of exposure : one good day of \emptyset to 900 W/m^2 horizontal intensity in summer.

II. Pyramometers comparison.

- * Under 200 w/m^2 of intensity, we can find from 10 to 50% (absolute value) relative errors of different KIPP-ZONEN pyramometers calibrated with the above method even taking into account the influence of the age and temperature of the instruments.
6 to 15% absolute value is the field of relative errors over 200 W/m^2 of intensity.
- * Regarding that funny behaviour of the KIPP-ZONEN pyramometers, now we use the Eppley PSP pyramometer and mean differences are found systematically between Eppley and KIPP-ZONEN pyramometers as shown ont the following graph.

I_E = Standard intensity (Eppley)

ΔI = Kipp - Eppley Intensities

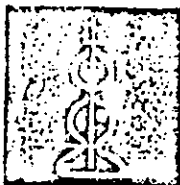

KIPP & ZONEN

CALIBRATION CERTIFICATE
=====

Calibration effected according to International Pyrheliometer
Scale 1956

Solarimeter for outdoor installation type CM 5 - Serial No. 785047

A radiation of $1 \text{ gcal cm}^{-2} \text{ min}^{-1}$ produces an E M F of 8.7 mV

A radiation of 1 Wcm^{-2} produces an E M F of 125 mV

Resistance of thermopile 9.7 Ohms.

Calibration of Solarimeter in conjunction with
Millivoltmeter type XZ 19 - Serial No.:

Solarimeter connected to terminals of the Millivoltmeter:

On 12 mV range: A deflection of 1 scale division is obtained for
a radiation of $\text{gcal cm}^{-2} \text{ min}^{-1}$

On 30 mV range: A deflection of 1 scale division is obtained for
a radiation of $\text{gcal cm}^{-2} \text{ min}^{-1}$

On 60 mV range: A deflection of 1 scale division is obtained for
a radiation of $\text{gcal cm}^{-2} \text{ min}^{-1}$

EF NO

Delft, Nov. 1978

KIPP & ZONEN



Use of galvanometer type AL 4 - MICROVA in conjunction with thermopiles

The calibration certificates of the thermopiles give the electromotive force (EMF) produced by the pile for a certain amount of incident radiation.

The voltage read on the galvanometer is related to the EMF of the thermopile by the simple equation:

$$V_g = \frac{R_g}{R_s + R_g} \cdot (\text{EMF}) \text{ or } \text{EMF} = \frac{R_s + R_g}{R_g} \cdot V_g$$

R_g is the galvanometer resistance at the relevant range

where V_g is the voltage read on the galvanometer

R_s is the resistance of the source (thermopile)

The input resistance of the galvanometer AL 4 equals 500.000 Ohms/Volt or:

0.5 mV range	$R_g = 250$	Ohms
1.5 " "	750	" "
5.0 " "	2500	" "
15 " "	7500	" "
50 " "	25k	" "

EXAMPLE:

The thermopile has a resistance of $R_s = 60$ Ohms and produces an EMF of 50 microvolts.

for an incident radiation of $1 \text{ Cal.m}^{-2} \cdot \text{h}^{-1}$.

For the radiation to be measured, we get a deflection of 100 scale divisions on the 1.5 mV range of the galvanometer.

The voltage measured thus equals 1 mV and $R_g = 750$ Ohms.

The EMF of the pile is now evaluated tot be : $\text{EMF} = \frac{60 + 750}{750} \cdot 1 = 1.08 \text{ mV}$.

The incident radiation was $\frac{1.08 \cdot 10^{-3}}{5.10^{-5}} = 21.6 \text{ Cal.m}^{-2} \cdot \text{h}^{-1}$.



EIDG. INSTITUT FÜR REAKTORFORSCHUNG
INSTITUT FÉDÉRAL DE RECHERCHES EN MATIÈRE DE RÉACTEURS

5303 WÜRENLINGEN (Schweiz)
Telegramme: REAKTOR WÜRENLINGEN
Telephon (056) 98 17 41
Telex 537 14 eir ch

Mr.
Dr. Michael R. Riches
U.S. Department of Energy
Office of Energy Research, ER-14
Mail Station G-256

Washington, DC. USA 20545

Ihr Zeichen
V. référence

Ihre Nachricht vom
V. communication du

Unser Zeichen
N. référence
SJQ/shq

5303 Würenlingen December 8, 1980

Concerns: round robin pyranometer calibration/
IEA solar heating & cooling program, task 3

Dear Dr. Riches,

Please find enclosed the calibration certificates concerning our reference pyranometer (Kipp & Zonen, CM5-76 3000). The instrument was sent yesterday to Dr. Wardle, National Atmospheric Radiation Center, Downsview, Canada.

The calibration procedures used are the standard procedures of PMOD, Davos.

Sincerely,

Dr. J.M. Suter, Physicist
responsible for IEA task 3
in Switzerland

Enclosures

KIPP & ZONEN

Swiss federal Institute for Reactor Research
Data concerning our reference pyrheliometer

CALIBRATION CERTIFICATE

Calibration effected according to International Pyrheliometer
Scale 1956

Solarimeter for outdoor installation type CM 5 - Serial No. *763000*

A radiation of $1 \text{ gcal cm}^{-2} \text{ min}^{-1}$ produces an E M F of *8,3* mV

A radiation of 1 Wcm^{-2} produces an E M F of *119* mV

Resistance of thermopile *9,5* Ohms.

Calibration of Solarimeter in conjunction with
Millivoltmeter type XZ 19 - Serial No.:

Solarimeter connected to terminals of the Millivoltmeter:

On 12 mV range: A deflection of 1 scale division is obtained for
a radiation of $\text{gcal cm}^{-2} \text{ min}^{-1}$

On 30 mV range: A deflection of 1 scale division is obtained for
a radiation of $\text{gcal cm}^{-2} \text{ min}^{-1}$

On 60 mV range: A deflection of 1 scale division is obtained for
a radiation of $\text{gcal cm}^{-2} \text{ min}^{-1}$

BF NO

Delft, *June 15 '76*
KIPP & ZONEN

27. September 1976

CALIBRATION CERTIFICATE

Instrument: Type: CM 5 Kipp + Zonen
No. : 76 3000

Sensitivity: 11.6 $\mu\text{V m}^2 \text{W}^{-1}$ (with no load)

Standard deviation
of single measurement: 0.06 $\mu\text{V m}^2 \text{W}^{-1}$

Number of measurements: 104

Calibration procedure: Source: sun and sky
pyranometer horizontal Intensity: 640 to 1005 Wm^{-2}
Sun height: 45 to 61 degrees
Instr. temp.: 19.5 to 24.0°C
Dates: 30.7. and 3.8.1976

Resistance: 9.0 Ohms at +20°C

Reference: IPS 1956, as defined during
IPC III 1970 and IPC IV 1975

Remarks: --

C. Fröhlich

Dr. C. Fröhlich
Head, World Radiation Center

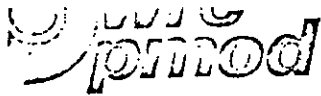

1978

CALIBRATION CERTIFICATE

Instrument: Type: CM5, Kipp + Zonen
No. : 76 30 00

Sensitivity: 11.31 $\mu\text{V m}^2 \text{W}^{-1}$ (with no load)

Single measurement's standard deviation: 0.08 $\mu\text{V m}^2 \text{W}^{-1}$

Number of measurements: 344

Calibration procedure: *pyranometer horizontal* Source: sun and sky
Intensity: 508 to 893 Wm^{-2}
Sun height: 30.7 to 55.6 degrees
Instr. temp.: +19.0 to 25.8 °C
Dates: 14./15./22.8.1978
Standard instrument: Pyranometer 6703-A

Resistance: 8.98 Ohms at +20 °C

Radiometric Reference: World Radiometric Reference (WRR),
according to Rec. 8/2 (CIMO-VII, August 1977).
To express measurements referred to WRR
according to IPS 1956, the WRR intensities
have to be decreased by 2.2 %.

C. Fröhlich

Dr. C. Fröhlich

Eichung 1979

Standardization of Pyranometer

Model: *Kipp + Zonen, CM5*
 Serial No: *76 3000*
 Resistance at 20°C: *8.95 Ω*

This pyranometer has been compared with the WRC reference pyranometer with the sun - and sky radiation as source under more or less clear sky conditions. The instrument was placed so that the output cable pointed North. The reference pyranometer is periodically calibrated against the World Standard Group with the shading technique in the horizontal, and if necessary, in an inclined position. The readings are referred to the World Radiometric Reference (WRR) as stated in the WMO Technical Regulations [A.1.2.] 4.9.1, adopted by Congress 1979. To express measurements referred to WRR according to IPS 1956, the WRR intensities have to be decreased by 2.2 %.

The inclination of the normal of the receiver surface against the vertical was set to 0 degrees. During the standardization, the instrument received radiation intensities from 656 to 884 Wm⁻² and the angle between the solar beam and the receiver surface ranged from 41 to 57 degrees. The instrument's temperature ranged from 18 to 29 with a mean of 24.6 °C. The sensitivity determined as a mean of 246 individual measurements and the single measurement standard deviation amounts to

$$\underline{11.36 \pm 0.06 \mu\text{VW}^{-1}\text{m}^{-2}}$$

Remarks:

Date of test: *1979, Aug 14/15/16*

In charge of test: *J. Füssler*

Date: *October 5, 1979*

Eichung 1979

Standardization of Pyranometer

Model: *Kipp + Zonen, CM5*
 Serial No: *76 30 00*
 Resistance at 20°C: *8.95 Ω*

This pyranometer has been compared with the WRC reference pyranometer with the sun - and sky radiation as source under more or less clear sky conditions. The instrument was placed so that the output cable pointed North. The reference pyranometer is periodically calibrated against the World Standard Group with the shading technique in the horizontal, and if necessary, in an inclined position. The readings are referred to the World Radiometric Reference (WRR) as stated in the WMO Technical Regulations [A.1.2.] 4.9.1, adopted by Congress 1979. To express measurements referred to WRR according to IPS 1956, the WRR intensities have to be decreased by 2.2 %.

The inclination of the normal of the receiver surface against the vertical was set to 45 degrees. During the standardization, the instrument received radiation intensities from 641 to 1042 Wm⁻² and the angle between the solar beam and the receiver surface ranged from 39 to 77 degrees. The instrument's temperature ranged from 19 to 29 with a mean of 25.1 °C. The sensitivity determined as a mean of 357 individual measurements and the single measurement standard deviation amounts to

$$\underline{11.19 \pm 0.05 \mu\text{W}^{-1}\text{m}^{-2}}$$

Remarks:

Date of test: *1979, July 25, Aug 14/15/16*

In charge of test: *A. Finkler*

Date: *October 5, 1979*

PMOD/WRC
 Davos

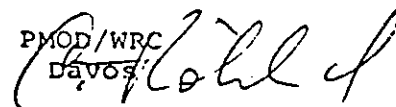

Standardization of Pyranometer

Model: Kipp + Zonen, CM5
 Serial No: 76 30 00
 Resistance at 20°C: 8.88 Ω

This pyranometer has been compared with the WRC reference pyranometer with the sun - and sky radiation as source under more or less clear sky conditions. The instrument was placed so that the output cable pointed North. The reference pyranometer is periodically calibrated against the World Standard Group with the shading technique in the horizontal, and if necessary, in an inclined position. The readings are referred to the World Radiometric Reference (WRR) as stated in the WMO Technical Regulations [A.1.2.] 4.9.1, adopted by Congress 1979. To express measurements referred to WRR according to IPS 1956, the WRR intensities have to be decreased by 2.2 %.

The inclination of the normal of the receiver surface against the vertical was set to 0 degrees. During the standardization, the instrument received radiation intensities from 403 to 759 Wm⁻² and the angle between the solar beam and the receiver surface ranged from 22.7 to 40.4 degrees. The instrument's temperature ranged from +5.3 to +8.5 with a mean of + 6.1°C. The sensitivity determined as a mean of 144 individual measurements and the single measurement standard deviation amounts to

$$\underline{11.36 \pm 0.05 \mu\text{VW}^{-1}\text{m}^2. *)}$$

Remarks: *) bezieht sich auf +20°C, Kabelausgang Richtung Süd

Date of test: March 12, 1980

In charge of test: *A. S. ...*



Date: 25. March 1980

PMOD/WRC
 Davos

Standardization of Pyranometer

Model: Kipp + Zonen, CM5
 Serial No: 76 30 00
 Resistance at 20°C: 8.88 Ω

This pyranometer has been compared with the WRC reference pyranometer with the sun - and sky radiation as source under more or less clear sky conditions. The instrument was placed so that the output cable pointed North. The reference pyranometer is periodically calibrated against the World Standard Group with the shading technique in the horizontal, and if necessary, in an inclined position. The readings are referred to the World Radiometric Reference (WRR) as stated in the WMO Technical Regulations [A.1.2.] 4.9.1, adopted by Congress 1979. To express measurements referred to WRR according to IPS 1956, the WRR intensities have to be decreased by 2.2 %.

The inclination of the normal of the receiver surface against the vertical was set to 40 degrees. During the standardization, the instrument received radiation intensities from 672 to 1192 Wm⁻² and the angle between the solar beam and the receiver surface ranged from 36.5 to 82.4 degrees. The instrument's temperature ranged from 10.1 to 15.8 with a mean of + 13.4°C. The sensitivity determined as a mean of 216 individual measurements and the single measurement standard deviation amounts to

$$\underline{11.04 \pm 0.04 \mu\text{W}^{-1}\text{m}^2. \quad *)}$$

Remarks: *) bezieht sich auf +20°C, Kabelausgang Richtung Süd

Date of test: March 18, 1980

In charge of test: *A. Fischer*

Date: 25. March 1980



PMOD/WRC
 Davos



METEOROLOGICAL OFFICE

Beaufort Park Easthampstead Wokingham Berkshire RG11 3DN

Telex 848160 & 847010

Telephone 0344 (Bracknell) 20242 ext 6263

Mr M R Riches
US Department of Energy
Office of Energy Research, ER-14
Mail Station G-256
WASHINGTON, DC
USA 20545

Please reply to The Director General
Our ref D/Met O 1/14/1/10

Your ref

Date 16 December 1980

Dear Mr Riches

I have been asked by Mr W G Durbin to reply to the call by Dr Dahlgren for some notes, for planning information, on pyranometer calibrations within our network. Enclosed, therefore, is a very brief description of our methods and an example of the differences obtained. I shall be sending CM5 773656 to Dr Wardle in Canada to participate in the planned tests on pyranometers used in the Davos comparisons of March 1980, we do not feel able to send CM2 2508 as it is the UK standard instrument. We look forward to the results of these calibrations with great interest.

Yours sincerely

J H Seymour
Met O 1c(1)

PYRANOMETER CALIBRATIONS WITHIN THE UK METEOROLOGICAL OFFICE

This note is a short description of the procedures employed during pyranometer calibrations within the Meteorological Office which is responsible for maintaining the UK radiation network through the National Radiation Centre at Beaufort Park just outside Bracknell. Two calibrations will be considered - that for our standards and that for our network instruments.

1. Standard Pyranometers

Our two standard pyranometers are Kipp CM2s and are calibrated against the sun using our reference pyrhemometers - comprising two Angstrom instruments together with a Kendall cavity radiometer by TMI. The pyranometers are mounted horizontally on an outside stand and can be shaded by discs on sun trackers - the solid angle subtended by the disc at the thermopile is the same as the effective aperture ($\approx 5^\circ$) of the pyrhemometers. The pyranometer outputs are logged on a potentiometric recorder at intervals of twenty seconds, the recorder being periodically calibrated using a high accuracy voltage source to determine the linearity of the scale readings. A record is obtained with one pyranometer shaded and the other unshaded and combining these results with simultaneous (manual) pyrhemometer readings, a suitable period of steady outputs for at least five minutes is chosen for the comparison. Next the pyranometer states are reversed and the process repeated. Finally, both instruments are shaded enabling the establishment of a ratio for diffuse irradiance between the two. These signals and ratios are used to evaluate the instrumental constant using the usual relationship linking shaded and unshaded outputs and the vertical component of the direct beam measurement.

This work takes place between March and September whenever weather conditions permit, the solar elevation being too low at Bracknell during winter (15° for December midday). Results are only used when the solar elevation is greater than 30° and preferably within an hour of local solar noon. The results are normalized to an intensity of 500 W m^{-2} and a temperature of 10°C using measured values of cosine response, temperature coefficient, and linearity.

2. Network Instruments

The normal calibration of a network instrument is performed in an integrating chamber after physical and electrical checks, and being radiometrically levelled using a light source at 75° zenith angle. The instrument mounting can carry three pyranometers, including the reference, with the bases shielded to prevent heating. Temperature control is used in conjunction with the ventilation systems to maintain the instrument temperature at $22^\circ\text{C} \pm 1/2^\circ\text{C}$ during calibration. The mounting is coupled to a motor permitting either clockwise or anti-clockwise rotation of the whole assembly through 360° in ten minutes in order to smooth out variations in signal caused by inhomogeneities in the diffusing surface. The outputs are monitored and processed using a high accuracy DVM, a multichannel scanner, and a microcomputer. The radiation source is six 600-W tungsten halogen lamps spaced equally around the chamber producing about 500 W m^{-2} at the thermopiles. The mounting rotates once each way (20 minutes) with outputs sampled every 10 seconds giving 120 data samples

for each pyranometer from which the sensitivity is calculated. The calibration factor is referenced to 10°C for the final certificate.

We have facilities for calibrating five pyranometers simultaneously outdoors using a six-channel integrator system with printers, the printing interval being usually 30 minutes. The instruments are mounted horizontally and left out for as long as possible - at least five days but preferably two or three weeks and the derived sensitivities for a variety of sky conditions are meant to produce a working value. However, low solar elevations are again discounted as are low intensities, say less than about 150 W m⁻².

3. Comparative Results from the Indoor and Outdoor Methods

The calibration constant determined by the outdoor method rarely agrees exactly with the figure obtained in the integrating chamber differences of 1-2% are common with the outdoor method usually giving the higher figure. Where there is a consistent difference the final calibration figure is biased toward that obtained outdoors because this is considered to be measured under more realistic conditions. Very often, too, neither figure agrees with that supplied by Kipp, a difference of 4-5% on occasions between the chamber and Kipp figures has been evident in the past. The UK network uses Kipp pyranometers exclusively, for measurements of global and diffuse radiation so we are not in a position to be able to compare, on a large scale, calibrations of different types of instruments. The following table indicates the sort of differences experienced. All the instruments are CM2s which had been refurbished by the manufacturer and calibrated on their return to Bracknell against our standard CM2s, thus the comparison is a viable one and depicts our normal experience.

Instrument	Kipp	Calibration Factor $\mu\text{V}/\text{W}/\text{m}^2$	
		Indoor	Outdoor
1061	12.6	12.6	12.8
1304	12.1	12.0	12.2
1634	11.4	11.2	11.45
1911	12.4	12.1	12.3
1986	11.6	11.5	11.5
1979	12.4	12.3	12.5
2345	11.8	11.7	11.9
2358	12.4	12.0	12.35
2365	11.9	11.8	12.1
2371	11.1	11.5	--
2389	12.0	11.85	12.2
2417	12.8	12.6	12.7
2464	12.1	11.8	12.0
2483	12.6	12.5	12.7
2504	12.3	12.0	12.3
2538	11.6	11.4	11.4
3124	11.6	11.8	11.9
3142	12.0	11.9	12.0
3147	12.7	12.6	12.8

As mentioned previously, we have no Eppley PSP instruments in routine use in the network for measurements on a horizontal surface. However, several customers outside the network have these and we have just acquired some to bring up a standard instrument for our calibration facility. Also now that many CM2 pyranometers are being replaced by CM5s because of age we are working on bringing up some good reference instruments of this type. We unfortunately have no facilities at present for doing other tests on sensors. Our present standards have been characterized in the past on equipment which either no longer exists or belongs to an outside organization. We are developing at the moment some equipment for producing cosine response plots in an automatic mode of operation based on the microcomputer mentioned earlier. The apparatus is constructed but problems with the light source have yet to be overcome.

J.H. Seymour

